

4MHz, Precision, Quad Operational Amplifier

The HA-5134 is a precision quad operational amplifier that is pin compatible with the OP-400, LT1014, OP11, RM4156, and LM148 as well as the HA-4741. Each amplifier features guaranteed maximum values for offset voltage of 200 μ V, offset voltage drift of 2 μ V/ $^{\circ}$ C, and offset current of 75nA over the full temperature range while CMRR/PSRR is guaranteed greater than 94dB and A_{VOL} is guaranteed above 500kV/V over the full temperature range.

Precision performance of the HA-5134 is enhanced by a noise voltage density of 7nV/ $\sqrt{\text{Hz}}$ at 1kHz, noise current density of 1pA/ $\sqrt{\text{Hz}}$ at 1kHz and channel separation of 120dB. Each unity-gain stable quad amplifier is fabricated using the dielectric isolation process to assure performance in the most demanding applications.

The HA-5134 is ideal for compact circuits such as instrumentation amplifiers, state-variable filters, and low-level transducer amplifiers. Other applications include precision data acquisition, precision integrators, and accurate threshold detectors in designs where board space is a limitation.

For military grade product, refer to the HA-5134/883 data sheet.

Ordering Information

PART NUMBER	TEMP. RANGE ($^{\circ}$ C)	PACKAGE	PKG. NO.
HA1-5134-5	0 to 75	14 Ld CERDIP	F14.3

Features

- Low Offset Voltage 200 μ V (Max)
- Low Offset Voltage Drift 2 μ V/ $^{\circ}$ C (Max)
- High Channel Separation 120dB
- Low Noise 7nV/ $\sqrt{\text{Hz}}$
- Unity Gain Bandwidth 4MHz
- High CMRR/PSRR 120dB (Typ)

Applications

- Instrumentation Amplifiers
- State-Variable Filters
- Precision Integrators
- Threshold Detectors
- Precision Data Acquisition Systems
- Low-Level Transducer Amplifiers

Pinout

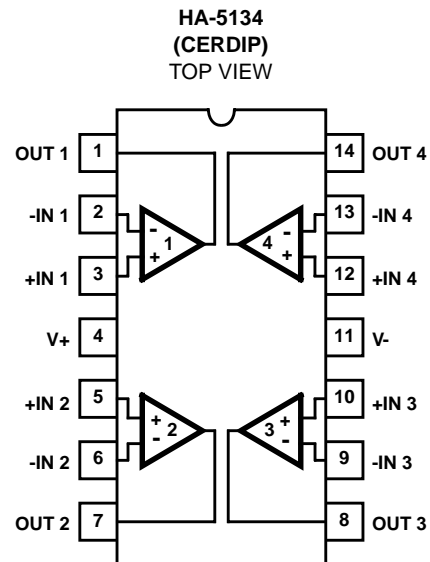

HA-5134

Absolute Maximum Ratings

Voltage Between V+ and V- Terminals 40V
 Differential Input Voltage (Note 2) 6V
 Output Current Full Short Circuit Protection

Thermal Information

Thermal Resistance (Typical, Note 1) θ_{JA} (°C/W) θ_{JC} (°C/W)
 CERDIP Package 80 30
 Maximum Junction Temperature (Note 3) 175°C
 Maximum Storage Temperature Range -65°C to 150°C
 Maximum Lead Temperature (Soldering 10s) 300°C

Operating Conditions

Temperature Range
 HA-5134-5 0°C to 75°C

CAUTION: Stresses above those listed in "Absolute Maximum Ratings" may cause permanent damage to the device. This is a stress only rating and operation of the device at these or any other conditions above those indicated in the operational sections of this specification is not implied.

NOTES:

1. θ_{JA} is measured with the component mounted on an evaluation PC board in free air.
2. For differential input voltages greater than 6V, the input current must be limited to 25mA to protect the back-to-back input diodes.
3. Maximum power dissipation, including output load, must be designed to maintain the maximum junction temperature below 175°C.

Electrical Specifications $V_{SUPPLY} = \pm 15V, R_L = 2k\Omega, C_L = 50pF, R_S \leq 100\Omega$, Unless Otherwise Specified

PARAMETER	TEST CONDITIONS	TEMP (°C)	HA-5134-5			UNITS
			MIN	TYP	MAX	
INPUT CHARACTERISTICS						
Offset Voltage		25	-	50	200	μV
		Full	-	75	350	μV
Average Offset Voltage Drift		Full	-	0.3	2	$\mu V/^\circ C$
Bias Current		25	-	± 10	± 50	nA
		Full	-	± 20	± 75	nA
Offset Current		25	-	10	50	nA
		Full	-	15	75	nA
Average Offset Current Drift		Full	-	0.05	-	nA/°C
Common Mode Range		Full	± 10	-	-	V
Differential Input Resistance		25	-	30	-	M Ω
Input Noise Voltage	0.1Hz to 10Hz	25	-	0.2	-	μV_{p-p}
Input Noise Voltage Density	f = 10Hz	25	-	10	-	nV/ \sqrt{Hz}
	f = 100Hz		-	7.5	-	nV/ \sqrt{Hz}
	f = 1kHz		-	7	-	nV/ \sqrt{Hz}
Input Noise Current Density	f = 10Hz	25	-	3	-	pA/ \sqrt{Hz}
	f = 100Hz		-	1.5	-	pA/ \sqrt{Hz}
	f = 1kHz		-	1	-	pA/ \sqrt{Hz}
TRANSFER CHARACTERISTICS						
Large Signal Voltage Gain	$V_{OUT} = \pm 10V$	25	800	1200	-	kV/V
		Full	500	750	-	kV/V
Common Mode Rejection Ratio	$V_{CM} = \pm 10V$	25	100	120	-	dB
		Full	94	115	-	dB
Minimum Stable Gain		25	1	-	-	V/V
Unity-Gain Bandwidth		25	-	4	-	MHz
OUTPUT CHARACTERISTICS						
Output Voltage Swing		Full	12	13.5	-	V
Output Current		25	-	20	-	mA

Electrical Specifications $V_{SUPPLY} = \pm 15V$, $R_L = 2k\Omega$, $C_L = 50pF$, $R_S \leq 100\Omega$, Unless Otherwise Specified **(Continued)**

PARAMETER	TEST CONDITIONS	TEMP (°C)	HA-5134-5			UNITS
			MIN	TYP	MAX	
Full Power Bandwidth (Note 4)		25	12	16	-	kHz
Channel Separation (Note 7)	$V_{OUT} = \pm 10V$	25	120	136	-	dB
TRANSIENT RESPONSE (Note 5)						
Rise Time	$A_V = +1$, $V_{OUT} = 200mV$	25	-	200	400	ns
Slew Rate	$A_V = +1$	25	0.75	1.0	-	V/ μs
Overshoot	$A_V = +1$	25	-	20	40	%
Settling Time (Note 6)		25	-	13	-	μs
POWER SUPPLY CHARACTERISTICS						
Supply Current	All Amps	Full	-	6.5	8	mA
Power Supply Rejection Ratio	$V_S = \pm 5V$ to $\pm 18V$	25	100	120	-	dB
		Full	94	115	-	dB

NOTES:

4. Full power bandwidth guaranteed based on slew rate measurement using: $FPBW = \frac{\text{Slew Rate}}{2\pi V_{PEAK}}$; $V_{PEAK} = 10V$.
5. Refer to Test Circuits section of the data sheet.
6. Specified to 0.01% of a 10V step, $A_V = -1$.
7. Guaranteed but not tested.

Test Circuits and Waveforms

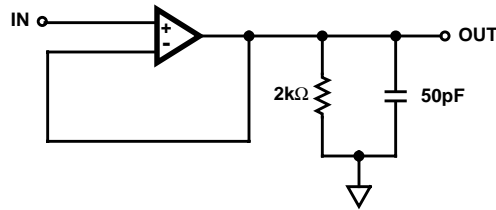
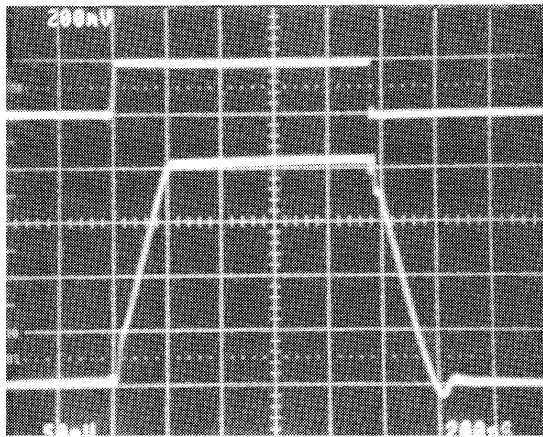
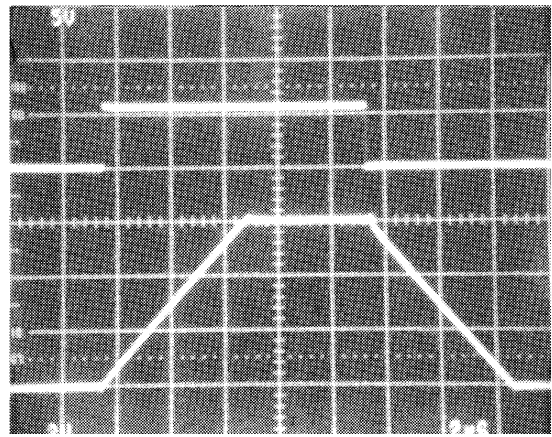

FIGURE 1. SLEW RATE AND TRANSIENT RESPONSE TEST CIRCUIT



Vertical: 50mV/Div., Horizontal: 200ns/Div.
 $T_A = 25^\circ C$, $V_S = \pm 15V$, $A_V = +1$, $R_L = 2k\Omega$, $C_L = 50pF$

SMALL SIGNAL RESPONSE



Vertical: 2V/Div., Horizontal: 2 μs /Div.
 $T_A = 25^\circ C$, $V_S = \pm 15V$, $A_V = +1$, $R_L = 2k\Omega$, $C_L = 50pF$

LARGE SIGNAL RESPONSE

Test Circuits and Waveforms (Continued)

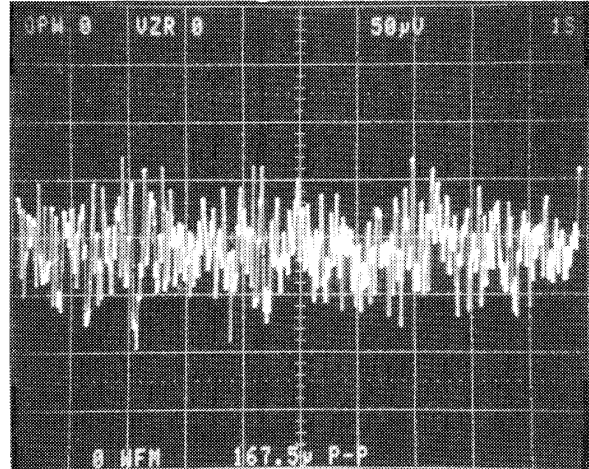
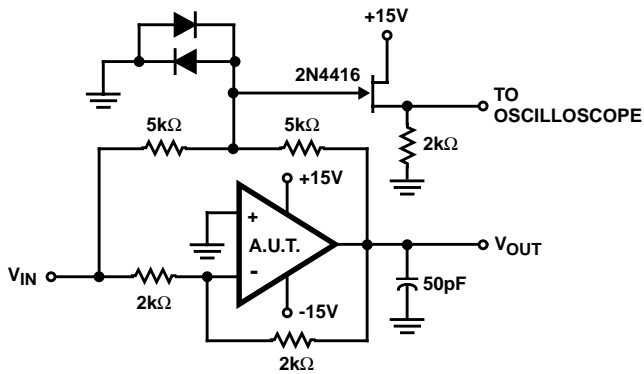

NOTES:

- 8. $A_V = -1$.
- 9. Feedback and summing resistors should be 0.1% matched.
- 10. Clipping diodes are optional. HP5082-2810 recommended.

$T_A = 25^\circ\text{C}$, $V_S = \pm 15\text{V}$, $A_V = 1000$
 $e_n = 0.167\mu\text{V}_{\text{P-P}}$
 $0.05\mu\text{V}/\text{Div.}, 1\text{s}/\text{Div.}$

FIGURE 2. SETTLING TIME CIRCUIT

PEAK-TO-PEAK NOISE 0.1Hz to 10Hz

Schematic Diagram (Each Amplifier)

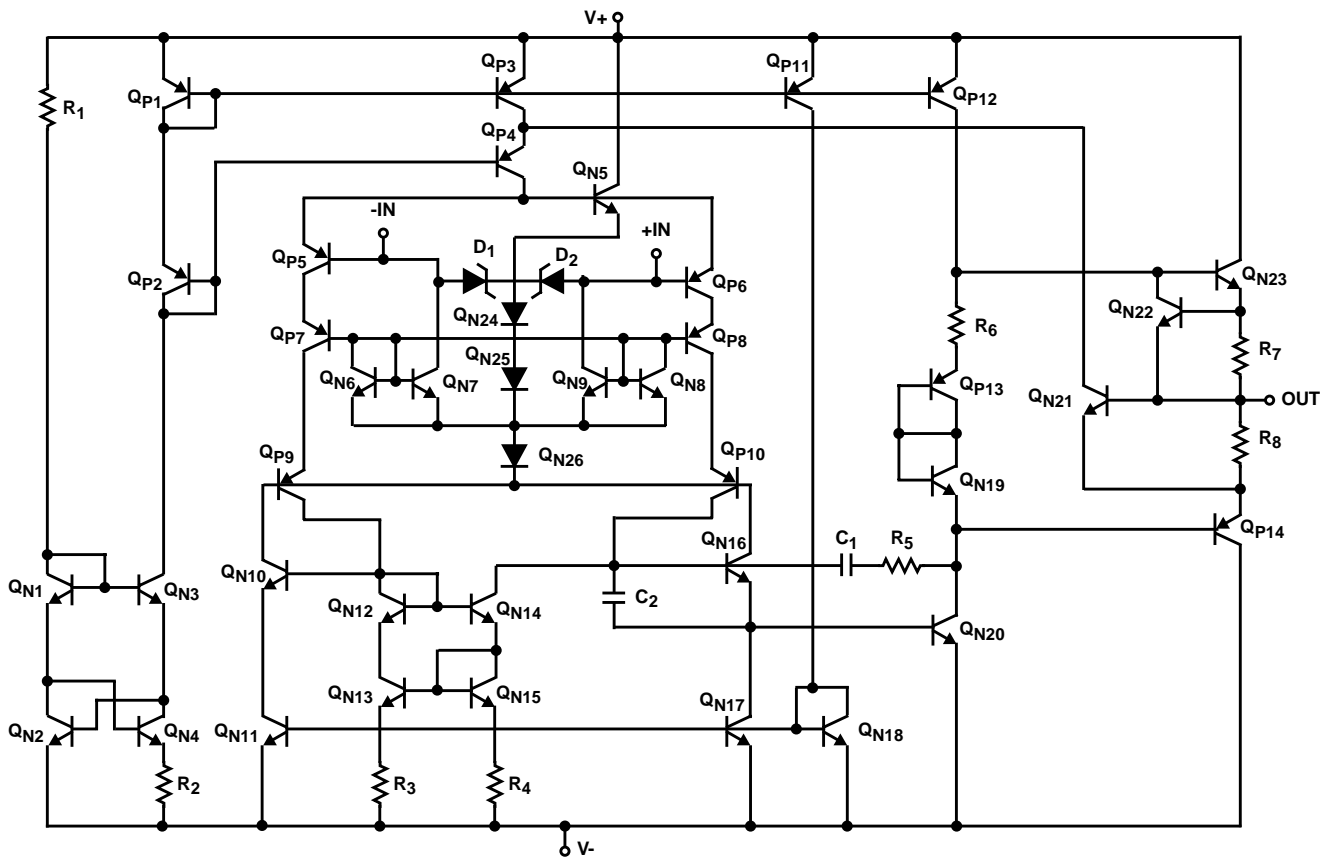

Application Information

Power Supply Decoupling

Although not absolutely necessary, it is recommended that all power supply lines be decoupled with 0.01μF ceramic capacitors to ground. Decoupling capacitors should be located as near to the amplifier terminals as possible.

Considerations For Prototyping

The following list of recommendations are suggested for prototyping.

1. Resolving low level signals requires minimizing leakage currents caused by external circuitry. Use of quality insulating

materials, thorough cleaning of insulating surfaces and implementation of moisture barriers when required is suggested.

2. Error voltages generated by thermocouples formed between dissimilar metals in the presence of temperature gradients should be minimized. Isolation of low level circuitry from heat generating components is recommended.
3. Shielded cable input leads, guard rings and shield drivers are recommended for the most critical applications.

Typical Applications

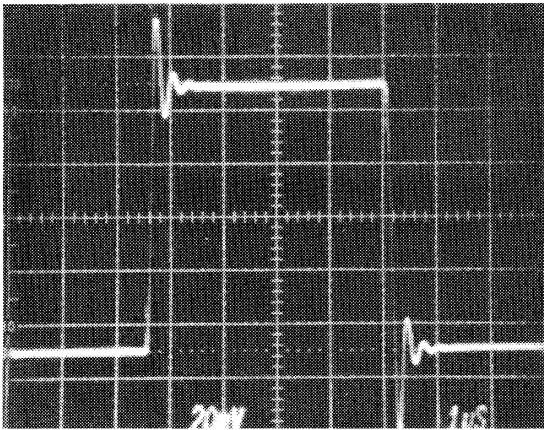
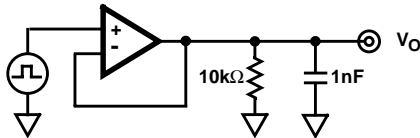

$T_A = 25^\circ\text{C}$, $V_S = \pm 15\text{V}$, $A_V = 1$, $R_L = 10\text{k}\Omega$
20mV/Div., 1μs/Div.

FIGURE 3. SMALL SIGNAL TRANSIENT RESPONSE
($C_{LOAD} = 1\text{nF}$)

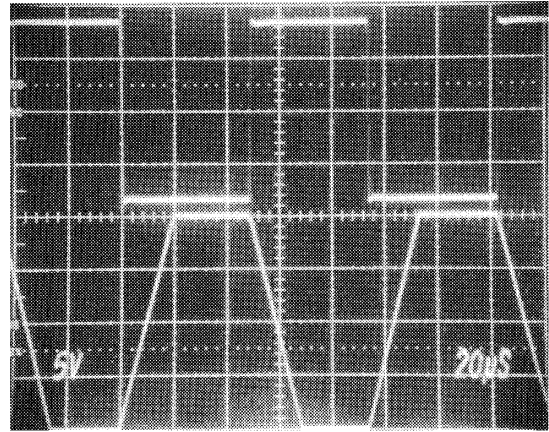

$V_{OUT} = \pm 10\text{V}$, $R_{LOAD} = 50\Omega$, $C_{LOAD} = 0.01\mu\text{F}$, $A_V = 3$, $V_S = \pm 15\text{V}$
Top: Input, 2V/Div., 20μs/Div. Bottom: Output, 5V/Div, 20μs/Div.

TRANSIENT RESPONSE OF APPLICATION CIRCUIT #1

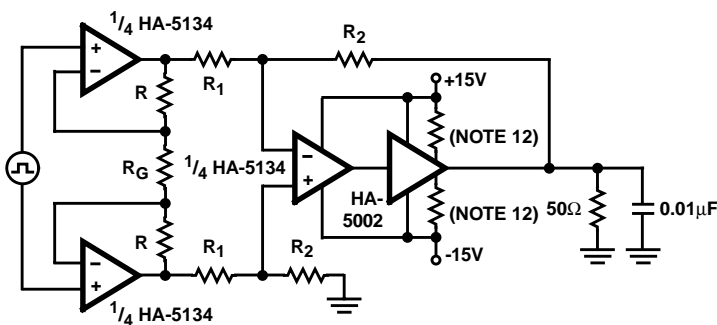
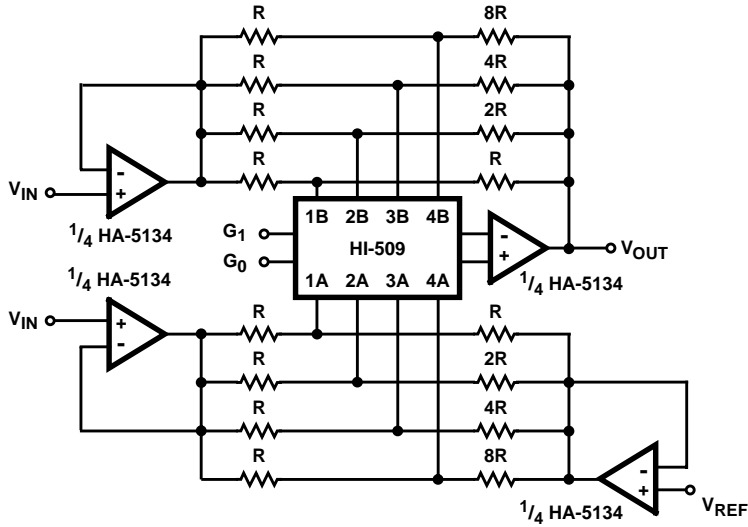

FIGURE 4. APPLICATION CIRCUIT #1: INSTRUMENTATION AMPLIFIER WITH POWER OUTPUT

NOTES:

11. $-A_V = \left(1 + \frac{2R}{R_G}\right) \left(\frac{R_2}{R_1}\right)$.
12. 10Ω - 100Ω recommended for short circuit limiting.
13. When driving heavy loads the HA-5002 may contribute to thermal errors. Proper thermal shielding is recommended.

Typical Applications (Continued)



G_1	G_0	A_V
0	0	-1
0	1	-2
1	0	-4
1	1	-8

High A_{VOL} of HA-5134 reduces gain error.
Gain Error $\cong 0.004\%$ at $A_V = 8$.

FIGURE 5. APPLICATION CIRCUIT #2: PROGRAMMABLE GAIN AMPLIFIER

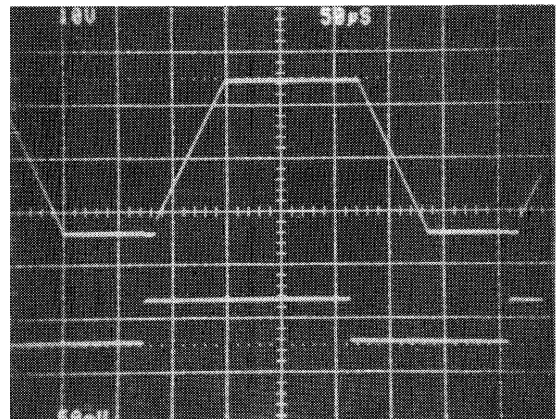
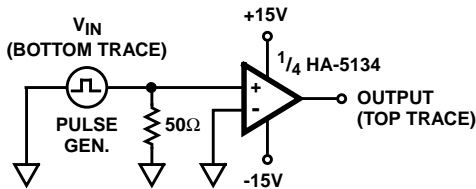

Horizontal: $50\mu s/Div.$
 $V_{IN} = \pm 25mV, V_{OUT} = \pm 14V$

NOTE: If differential input voltages greater than 6V are present, input current must be limited to less than 25mA.

FIGURE 6. APPLICATION CIRCUIT #3: PRECISION COMPARATOR

Typical Performance Curves

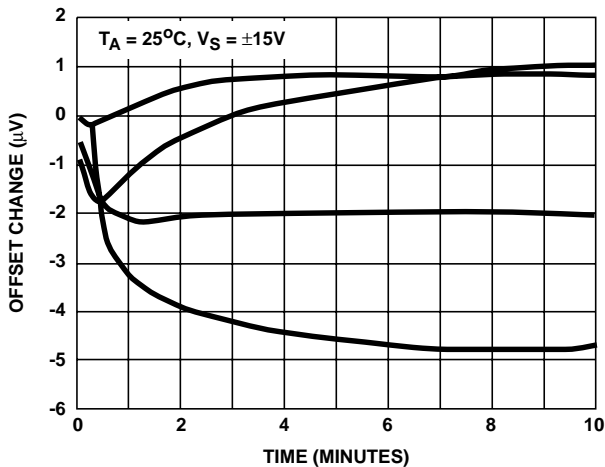

FIGURE 7. V_{IO} WARM-UP DRIFT

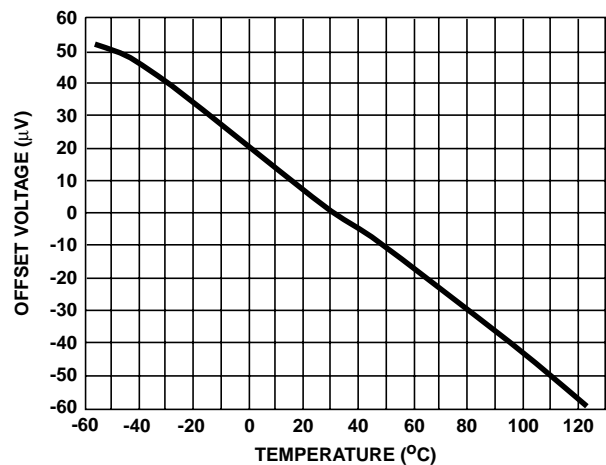

FIGURE 8. INPUT OFFSET VOLTAGE vs TEMPERATURE

Typical Performance Curves (Continued)

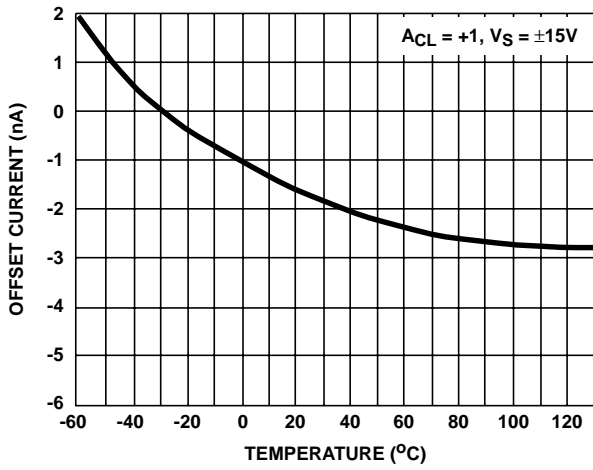

FIGURE 9. OFFSET CURRENT vs TEMPERATURE

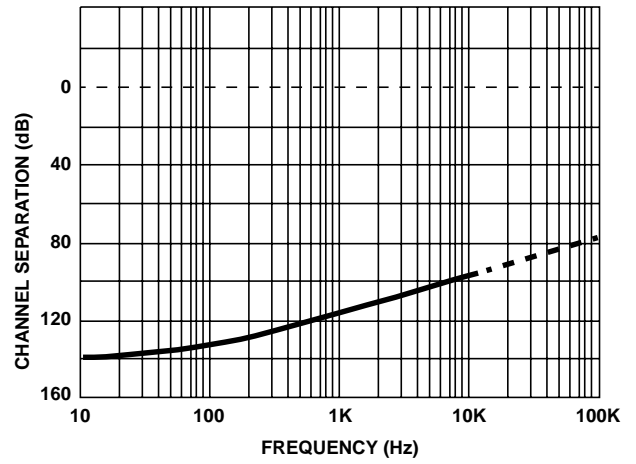

FIGURE 10. CHANNEL SEPARATION vs FREQUENCY

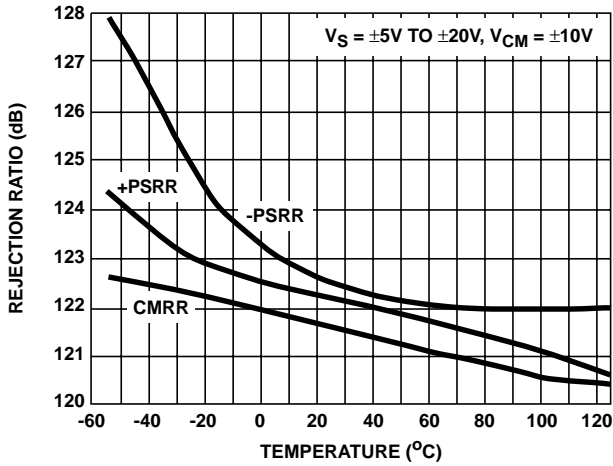

FIGURE 11. REJECTION RATIOS vs TEMPERATURE

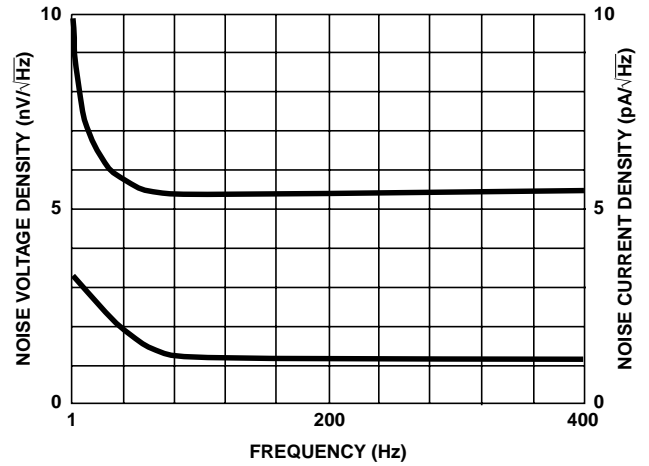

FIGURE 12. NOISE DENSITY vs FREQUENCY

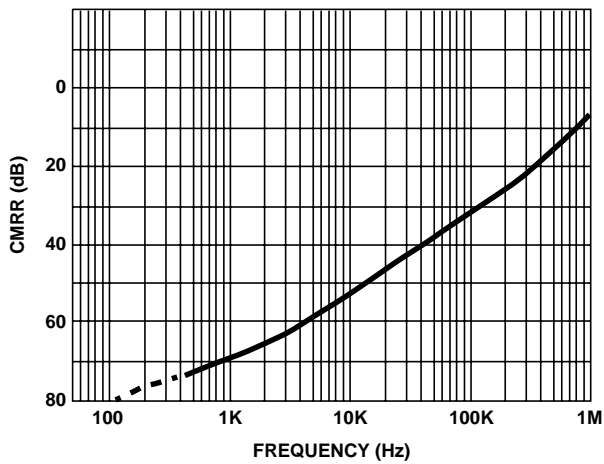

FIGURE 13. CMRR vs FREQUENCY

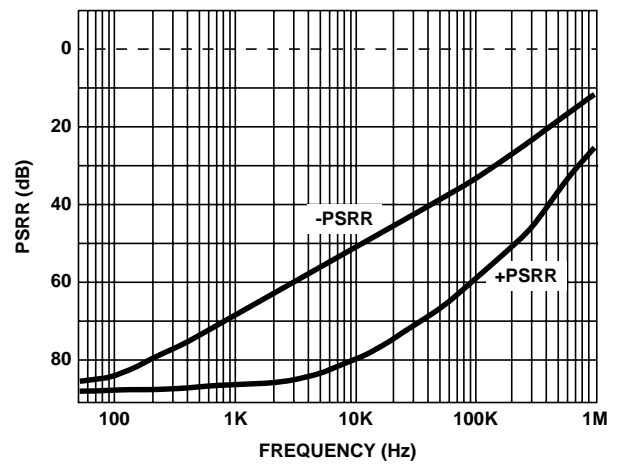

FIGURE 14. PSRR vs FREQUENCY

Typical Performance Curves (Continued)

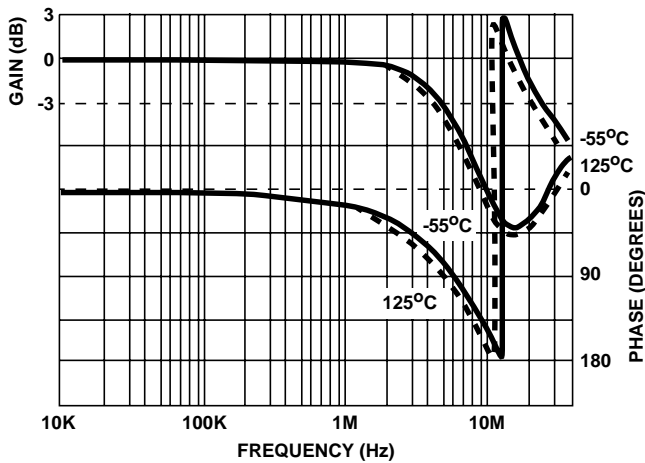

FIGURE 15. CLOSED LOOP FREQUENCY RESPONSE

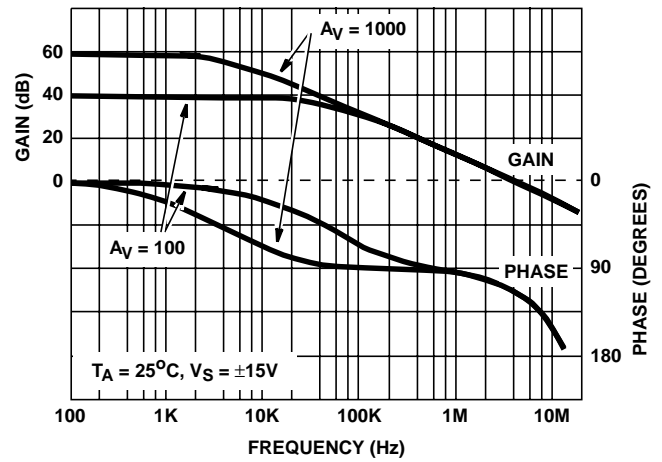

FIGURE 16. CLOSED LOOP GAIN/PHASE vs FREQUENCY

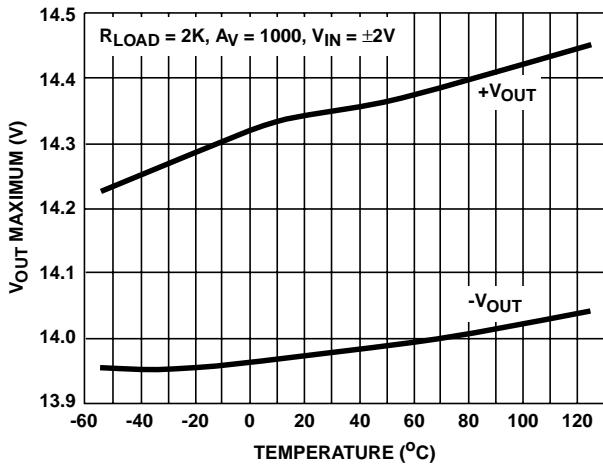

FIGURE 17. MAXIMUM OUTPUT VOLTAGE vs TEMPERATURE

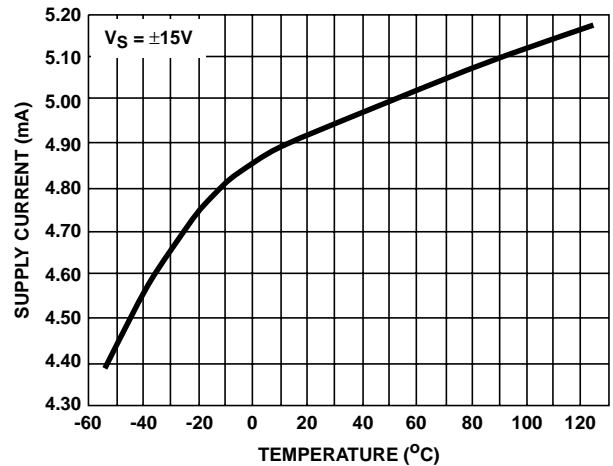

FIGURE 18. SUPPLY CURRENT vs TEMPERATURE

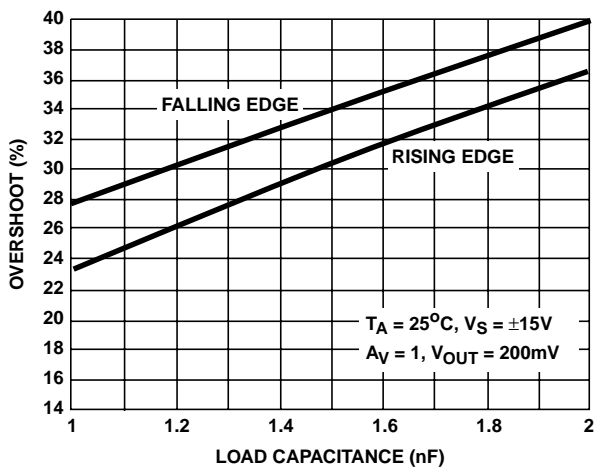

FIGURE 19. OVERSHOOT vs C_{LOAD}

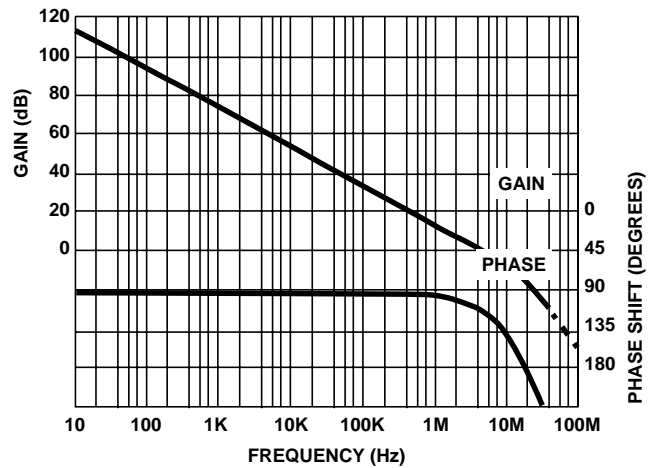

FIGURE 20. OPEN LOOP GAIN AND PHASE vs FREQUENCY

All Intersil semiconductor products are manufactured, assembled and tested under **ISO9000** quality systems certification.

Intersil semiconductor products are sold by description only. Intersil Corporation reserves the right to make changes in circuit design and/or specifications at any time without notice. Accordingly, the reader is cautioned to verify that data sheets are current before placing orders. Information furnished by Intersil is believed to be accurate and reliable. However, no responsibility is assumed by Intersil or its subsidiaries for its use; nor for any infringements of patents or other rights of third parties which may result from its use. No license is granted by implication or otherwise under any patent or patent rights of Intersil or its subsidiaries.

For information regarding Intersil Corporation and its products, see web site **www.intersil.com**

Sales Office Headquarters

NORTH AMERICA

Intersil Corporation
P. O. Box 883, Mail Stop 53-204
Melbourne, FL 32902
TEL: (321) 724-7000
FAX: (321) 724-7240

EUROPE

Intersil SA
Mercure Center
100, Rue de la Fusee
1130 Brussels, Belgium
TEL: (32) 2.724.2111
FAX: (32) 2.724.22.05

ASIA

Intersil (Taiwan) Ltd.
7F-6, No. 101 Fu Hsing North Road
Taipei, Taiwan
Republic of China
TEL: (886) 2 2716 9310
FAX: (886) 2 2715 3029