

April 1995

34A, 1200V N-Channel IGBT

Features

- 34A, 1200V
- Latch Free Operation
- Typical Fall Time - 780ns
- High Input Impedance
- Low Conduction Loss

Description

The HGTG20N120E2 is a MOS gated, high voltage switching device combining the best features of MOSFETs and bipolar transistors. The device has the high input impedance of a MOSFET and the low on-state conduction loss of a bipolar transistor. The much lower on-state voltage drop varies only moderately between +25°C and +150°C.

IGBTs are ideal for many high voltage switching applications operating at frequencies where low conduction losses are essential, such as: AC and DC motor controls, power supplies and drivers for solenoids, relays and contactors. The development type number for this device is TA49009.

PACKAGING AVAILABILITY

PART NUMBER	PACKAGE	BRAND
HGTG20N120E2	TO-247	G20N120E2

Package

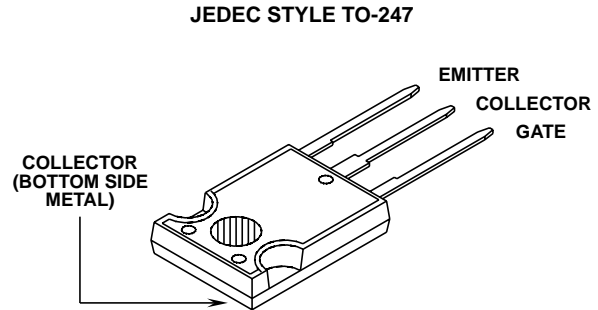

Terminal Diagram

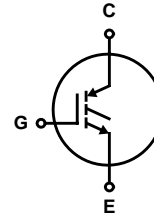

Absolute Maximum Ratings $T_C = +25^\circ\text{C}$, Unless Otherwise Specified

	HGTG20N120E2	UNITS
Collector-Emitter Breakdown Voltage.....	1200	V
Collector-Gate Breakdown Voltage $R_{GE} = 1M\Omega$	1200	V
Collector Current Continuous		
At $T_C = +25^\circ\text{C}$	34	A
At $T_C = +90^\circ\text{C}$	20	A
Collector Current Pulsed (Note 1)	100	A
Gate-Emitter Voltage Continuous.....	± 20	V
Gate-Emitter Voltage Pulsed	± 30	V
Switching SOA at $T_C = +150^\circ\text{C}$	100A at 0.8 BV_{CES}	-
Power Dissipation Total at $T_C = +25^\circ\text{C}$	150	W
Power Dissipation Derating $T_C > +25^\circ\text{C}$	1.20	W/ $^\circ\text{C}$
Operating and Storage Junction Temperature.....	-55 to +150	$^\circ\text{C}$
Maximum Lead Temperature for Soldering	260	$^\circ\text{C}$
(0.125" from case for 5 seconds)		
Short Circuit Withstand Time (Note 2)		
At $V_{GE} = 15\text{V}$	3	μs
At $V_{GE} = 10\text{V}$	15	μs

NOTES:

1. Repetitive Rating: Pulse width limited by maximum junction temperature.
2. $V_{CE(PEAK)} = 720\text{V}$, $T_C = +125^\circ\text{C}$, $R_{GE} = 25\Omega$

HARRIS SEMICONDUCTOR IGBT PRODUCT IS COVERED BY ONE OR MORE OF THE FOLLOWING U.S. PATENTS:

4,364,073	4,417,385	4,430,792	4,443,931	4,466,176	4,516,143	4,532,534	4,567,641
4,587,713	4,598,461	4,605,948	4,618,872	4,620,211	4,631,564	4,639,754	4,639,762
4,641,162	4,644,637	4,682,195	4,684,413	4,694,313	4,717,679	4,743,952	4,783,690
4,794,432	4,801,986	4,803,533	4,809,045	4,809,047	4,810,665	4,823,176	4,837,606
4,860,080	4,883,767	4,888,627	4,890,143	4,901,127	4,904,609	4,933,740	4,963,951
4,969,027							

Specifications HGTG20N120E2

Electrical Specifications $T_C = +25^\circ\text{C}$, Unless Otherwise Specified

PARAMETERS	SYMBOL	TEST CONDITIONS	LIMITS			UNIT	
			MIN	TYP	MAX		
Collector-Emitter Breakdown Voltage	BV_{CES}	$I_C = 250\mu\text{A}$, $V_{GE} = 0\text{V}$	1200	-	-	V	
Collector-Emitter Leakage Current	I_{CES}	$V_{CE} = BV_{CES}$	$T_C = +25^\circ\text{C}$	-	-	250	μA
		$V_{CE} = 0.8 BV_{CES}$	$T_C = +125^\circ\text{C}$	-	-	1.0	mA
Collector-Emitter Saturation Voltage	$V_{CE(SAT)}$	$I_C = I_{C90}$, $V_{GE} = 15\text{V}$	$T_C = +25^\circ\text{C}$	-	2.9	3.5	V
			$T_C = +125^\circ\text{C}$	-	3.0	3.6	V
		$I_C = I_{C90}$, $V_{GE} = 10\text{V}$	$T_C = +25^\circ\text{C}$	-	3.1	3.8	V
			$T_C = +125^\circ\text{C}$	-	3.3	4.0	V
Gate-Emitter Threshold Voltage	$V_{GE(TH)}$	$I_C = 500\mu\text{A}$, $V_{CE} = V_{GE}$	$T_C = +25^\circ\text{C}$	3.0	4.5	6.0	V
Gate-Emitter Leakage Current	I_{GES}	$V_{GE} = \pm 20\text{V}$	-	-	± 250	nA	
Gate-Emitter Plateau Voltage	V_{GEP}	$I_C = I_{C90}$, $V_{CE} = 0.5 BV_{CES}$	-	7.0	-	V	
On-State Gate Charge	$Q_{G(ON)}$	$I_C = I_{C90}$, $V_{CE} = 0.5 BV_{CES}$	$V_{GE} = 15\text{V}$	-	110	150	nC
			$V_{GE} = 20\text{V}$	-	150	200	nC
Current Turn-On Delay Time	$t_{D(ON)}$	$R_L = 48\Omega$	$I_C = I_{C90}$, $V_{GE} = 15\text{V}$, $V_{CE} = 0.8 BV_{CES}$, $R_G = 25\Omega$, $T_J = +125^\circ\text{C}$	-	100	-	ns
Current Rise Time	t_R			-	150	-	ns
Current Turn-Off Delay Time	$t_{D(OFF)I}$	$L = 50\mu\text{H}$		-	520	620	ns
Current Fall Time	t_{FI}			-	780	1000	ns
Turn-Off Energy (Note 1)	W_{OFF}			-	7.0	-	mJ
Current Turn-On Delay Time	$t_{D(ON)}$			$R_L = 48\Omega$	$I_C = I_{C90}$, $V_{GE} = 10\text{V}$, $V_{CE} = 0.8 BV_{CES}$, $R_G = 25\Omega$, $T_J = +125^\circ\text{C}$	-	100
Current Rise Time	t_R	-	150			-	ns
Current Turn-Off Delay Time	$t_{D(OFF)I}$	$L = 50\mu\text{H}$	-	420		520	ns
Current Fall Time	t_{FI}		-	780		1000	ns
Turn-Off Energy (Note 1)	W_{OFF}		-	7.0		-	mJ
Thermal Resistance	$R_{\theta JC}$			-		0.70	0.83

NOTE:

1. Turn-Off Energy Loss (W_{OFF}) is defined as the integral of the instantaneous power loss starting at the trailing edge of the input pulse and ending at the point where the collector current equals zero ($I_{CE} = 0\text{A}$). The HGTG20N120E2 was tested per JEDEC standard No. 24-1 Method for Measurement of Power Device Turn-Off Switching Loss. This test method produces the true total Turn-Off Energy Loss.

Typical Performance Curves

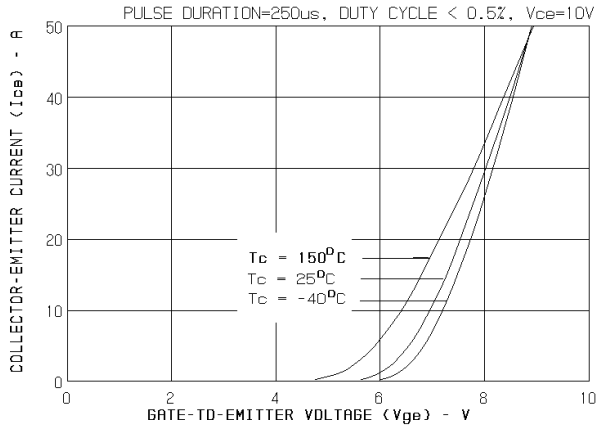

FIGURE 1. TRANSFER CHARACTERISTICS (TYPICAL)

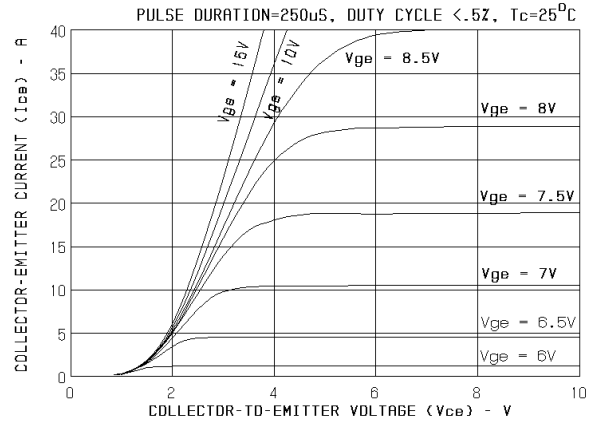

FIGURE 2. SATURATION CHARACTERISTICS (TYPICAL)

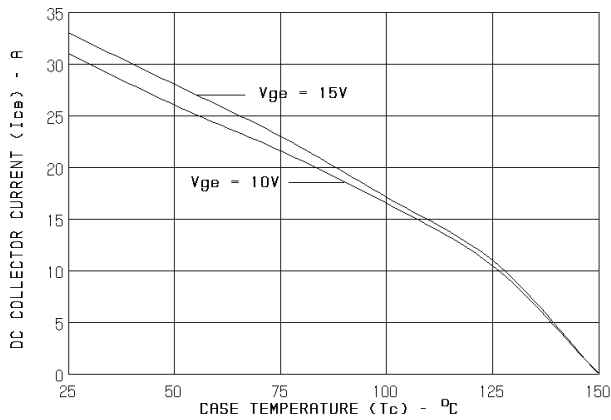

FIGURE 3. MAXIMUM DC COLLECTOR CURRENT AS A FUNCTION OF CASE TEMPERATURE

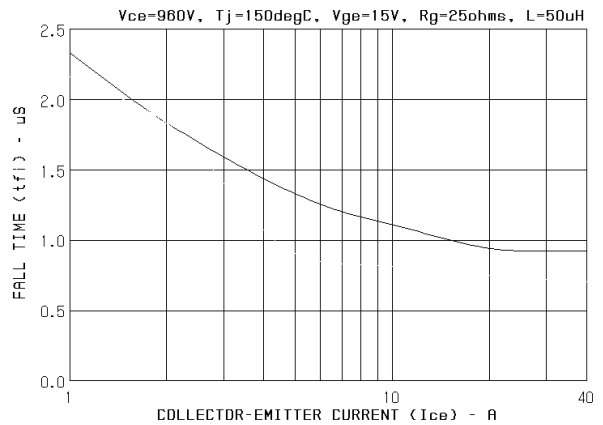

FIGURE 4. FALL TIME AS A FUNCTION OF COLLECTOR-EMITTER CURRENT

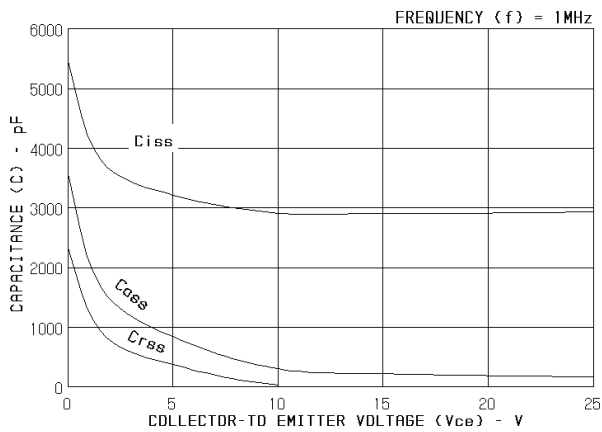

FIGURE 5. CAPACITANCE AS A FUNCTION OF COLLECTOR-EMITTER VOLTAGE

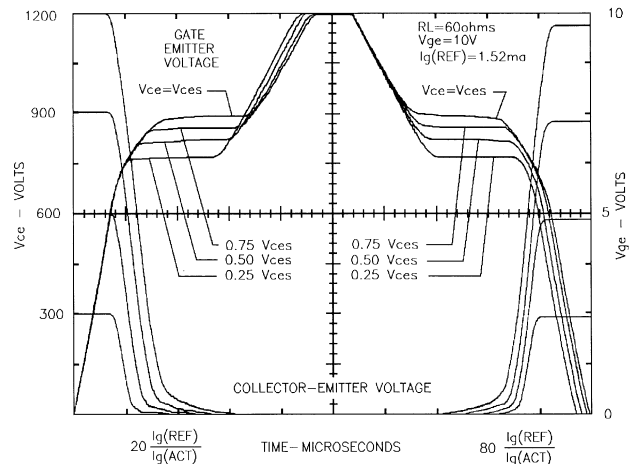

FIGURE 6. NORMALIZED SWITCHING WAVEFORMS AT CONSTANT GATE CURRENT. (REFER TO APPLICATION NOTES AN7254 AND AN7260)

Typical Performance Curves (Continued)

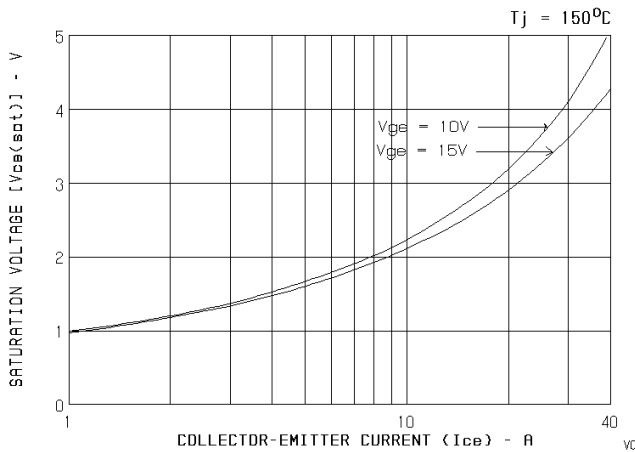

FIGURE 7. SATURATION VOLTAGE AS A FUNCTION OF COLLECTOR-EMITTER CURRENT

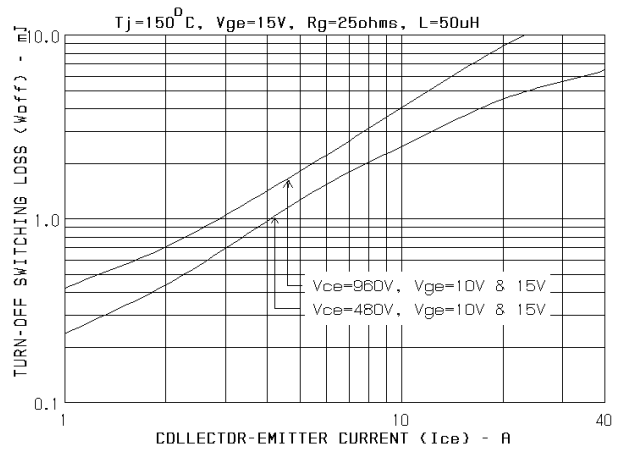

FIGURE 8. TURN-OFF SWITCHING LOSS AS A FUNCTION OF COLLECTOR-EMITTER CURRENT

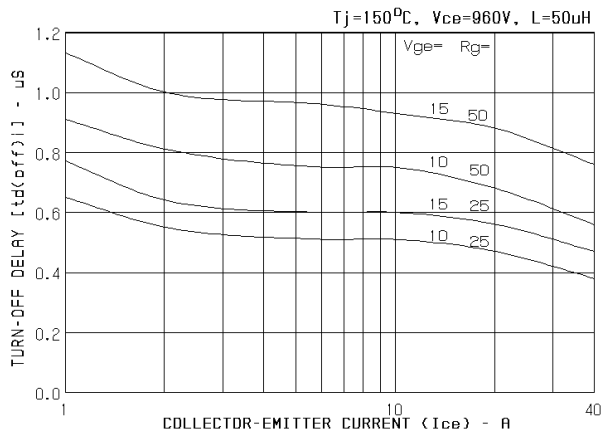

FIGURE 9. TURN-OFF DELAY AS A FUNCTION OF COLLECTOR-EMITTER CURRENT

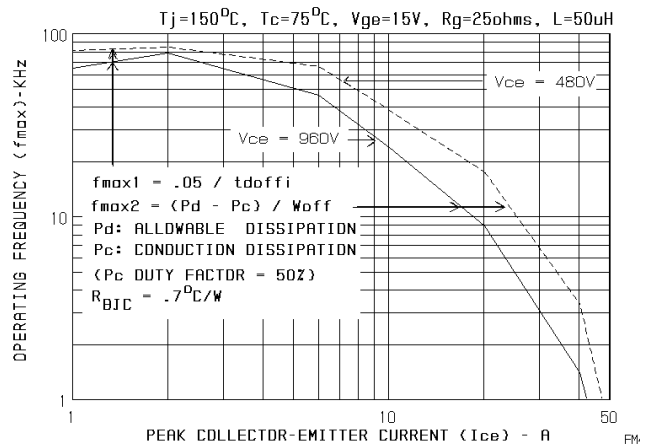

FIGURE 10. OPERATING FREQUENCY AS A FUNCTION OF COLLECTOR-EMITTER CURRENT AND VOLTAGE

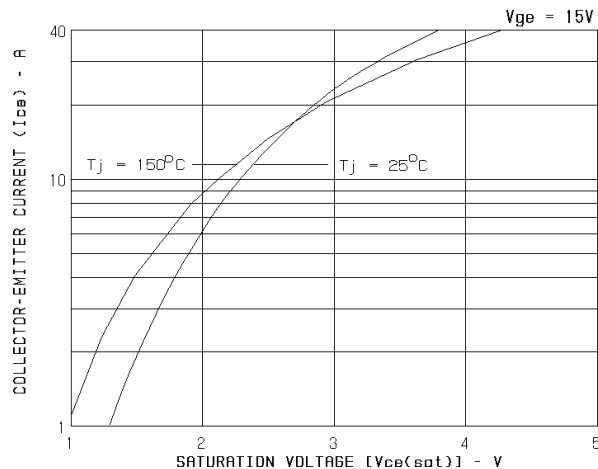

FIGURE 11. COLLECTOR-EMITTER SATURATION VOLTAGE

Test Circuit

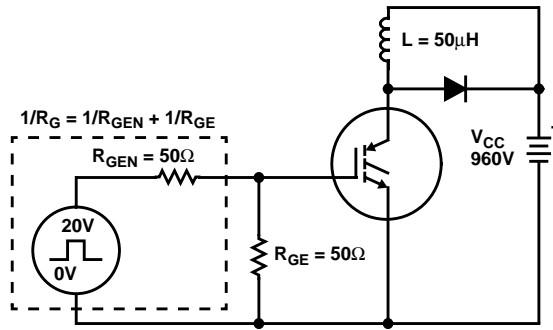

FIGURE 12. INDUCTIVE SWITCHING TEST CIRCUIT

Operating Frequency Information

Operating frequency information for a typical device (Figure 10) is presented as a guide for estimating device performance for a specific application. Other typical frequency vs collector current (I_{CE}) plots are possible using the information shown for a typical unit in Figures 7, 8 and 9. The operating frequency plot (Figure 10) of a typical device shows f_{MAX1} or f_{MAX2} whichever is smaller at each point. The information is based on measurements of a typical device and is bounded by the maximum rated junction temperature.

f_{MAX1} is defined by $f_{MAX1} = 0.05/t_{D(OFF)1}$. $t_{D(OFF)1}$ (the denominator) has been arbitrarily held to 10% of the on-state time for a 50% duty factor. Other definitions are possible. $t_{D(OFF)1}$ is defined as the time between the 90% point of the trailing edge of the input pulse and the point where the collector current falls to 90% of its maximum value. Device turn-off delay can establish an additional frequency limiting condition for an application other than T_{JMAX} . $t_{D(OFF)1}$ is important when controlling output ripple under a lightly loaded condition. f_{MAX2} is defined by $f_{MAX2} = (Pd - Pc)/W_{OFF}$. The allowable dissipation (Pd) is defined by $Pd = (T_{JMAX} - T_C)/R_{\theta JC}$. The sum of device switching and conduction losses must not exceed Pd. A 50% duty factor was used (Figure 10) and the conduction losses (Pc) are approximated by $Pc = (V_{CE} \cdot I_{CE})/2$. W_{OFF} is defined as the integral of the instantaneous power loss starting at the trailing edge of the input pulse and ending at the point where the collector current equals zero ($I_{CE} = 0A$).

The switching power loss (Figure 10) is defined as $f_{MAX2} \cdot W_{OFF}$. Turn switching losses are not included because they can be greatly influenced by external circuit conditions and components.

Handling Precautions for IGBTs

Insulated Gate Bipolar Transistors are susceptible to gate-insulation damage by the electrostatic discharge of energy through the devices. When handling these devices, care should be exercised to assure that the static charge built in the handler's body capacitance is not discharged through the device. With proper handling and application procedures, however, IGBTs are currently being extensively used in military, industrial and consumer applications, with virtually no damage problems due to electrostatic discharge. IGBTs can be handled safely if the following basic precautions are taken:

1. Prior to assembly into a circuit, all leads should be kept shorted together either by the use of metal shorting springs or by the insertion into conductive material such as "† ECCOSORB LD26" or equivalent.
2. When devices are removed by hand from their carriers, the hand being used should be grounded by any suitable means - for example, with a metallic wristband.
3. Tips of soldering irons should be grounded.
4. Devices should never be inserted into or removed from circuits with power on.
5. **Gate Voltage Rating** - Never exceed the gate-voltage rating of VGEM. Exceeding the rated VGE can result in permanent damage to the oxide layer in the gate region.
6. **Gate Termination** - The gates of these devices are essentially capacitors. Circuits that leave the gate open-circuited or floating should be avoided. These conditions can result in turn-on of the device due to voltage buildup on the input capacitor due to leakage currents or pickup.
7. **Gate Protection** - These devices do not have an internal monolithic zener diode from gate to emitter. If gate protection is required an external zener is recommended.

† Trademark Emerson and Cumming, Inc.