

Radiation Hardened Dual 4-Input NAND Gate

April 1995

Features

- 1.25 Micron Radiation Hardened SOS CMOS
- Total Dose 300K RAD (Si)
- Single Event Upset (SEU) Immunity <math>< 1 \times 10^{-10}</math> Errors/Bit-Day (Typ)
- SEU LET Threshold >80 MEV-cm²/mg
- Dose Rate Upset >10¹¹ RAD (Si)/s, 20ns Pulse
- Latch-Up Free Under Any Conditions
- Military Temperature Range: -55°C to +125°C
- Significant Power Reduction Compared to ALSTTL Logic
- DC Operating Voltage Range: 4.5V to 5.5V
- Input Logic Levels
 - VIL = 30% of VCC Max
 - VIH = 70% of VCC Min
- Input Current ≤1μA at VOL, VOH

Description

The Intersil ACS20MS is a radiation hardened dual 4-input NAND gate. A low on any input forces the output to a high logic state.

The ACS20MS utilizes advanced CMOS/SOS technology to achieve high-speed operation. This device is a member of the radiation hardened, high-speed, CMOS/SOS Logic Family.

Pinouts

14 LEAD CERAMIC DUAL-IN-LINE
MIL-STD-1835 DESIGNATOR, CDIP2-T14, LEAD FINISH C
TOP VIEW

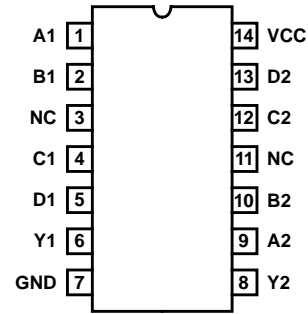

14 LEAD CERAMIC FLATPACK
MIL-STD-1835 DESIGNATOR, CDFP3-F14, LEAD FINISH C
TOP VIEW

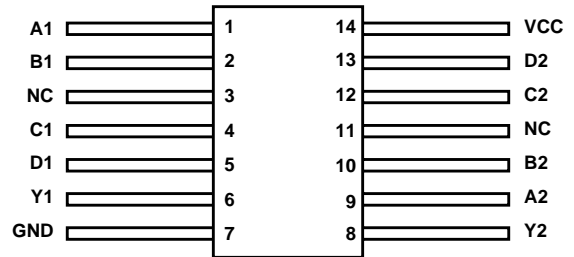

Ordering Information

PART NUMBER	TEMPERATURE RANGE	SCREENING LEVEL	PACKAGE
ACS20DMSR	-55°C to +125°C	Intersil Class S Equivalent	14 Lead SBDIP
ACS20KMSR	-55°C to +125°C	Intersil Class S Equivalent	14 Lead Ceramic Flatpack
ACS20D/Sample	+25°C	Sample	14 Lead SBDIP
ACS20K/Sample	+25°C	Sample	14 Lead Ceramic Flatpack
ACS20HMSR	+25°C	Die	Die

Truth Table

INPUTS				OUTPUT
An	Bn	Cn	Dn	Yn
L	X	X	X	H
X	L	X	X	H
X	X	L	X	H
X	X	X	L	H
H	H	H	H	L

NOTE: L = Logic Level Low, H = Logic level High, X = Don't Care

Functional Diagram

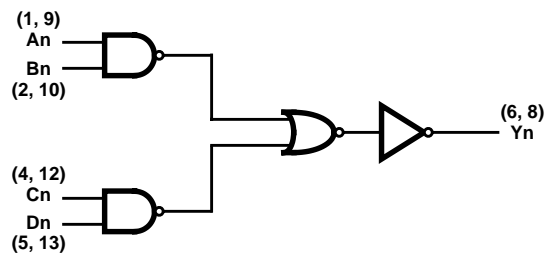

Specifications ACS20MS

Absolute Maximum Ratings

Supply Voltage	-0.5V to +6.0V
Input Voltage Range	-0.5V to VCC +0.5V
DC Input Current, Any One Input	±10mA
DC Drain Current, Any One Output	±50mA
Storage Temperature Range (TSTG)	-65°C to +150°C
Lead Temperature (Soldering 10s)	+265°C
Junction Temperature (TJ)	+175°C
ESD Classification	Class 1

(All Voltages Reference to VSS)

Reliability Information

Thermal Impedance	θ_{JA}	θ_{JC}
DIP	74°C/W	24°C/W
Flatpack	116°C/W	30°C/W
Maximum Package Power Dissipation at +125°C		
DIP	0.7W	
Flatpack	0.4W	
Maximum Device Power Dissipation	(TBD)W	
Gate Count	34 Gates	

CAUTION: Stresses above those listed in "Absolute Maximum Ratings" may cause permanent damage to the device. This is a stress only rating and operation of the device at these or any other conditions above those indicated in the operational sections of this specification is not implied.

Operating Conditions

Supply Voltage Range	+4.5V to +5.5V	Input High Voltage (VIH)	VCC to 70% of VCC
Input Rise and Fall Time at 4.5V VCC (TR, TF)	10ns/V Max	Input Low Voltage (VIL)	0V to 30% of VCC
Operating Temperature Range	-55°C to +125°C		

TABLE 1. DC ELECTRICAL PERFORMANCE CHARACTERISTICS

PARAMETER	SYMBOL	(NOTE 1) CONDITIONS	GROUP A SUB- GROUPS	TEMPERATURE	LIMITS		UNITS
					MIN	MAX	
Supply Current	ICC	VCC = 5.5V, VIN = VCC or GND	1	+25°C	-	5	μA
			2, 3	+125°C, -55°C	-	100	μA
Output Current (Source)	IOH	VCC = 4.5V, VIH = 4.5V, VOUT = VCC -0.4V, VIL = 0V, (Note 2)	1	+25°C	-12	-	mA
			2, 3	+125°C, -55°C	-8	-	mA
Output Current (Sink)	IOL	VCC = 4.5V, VIH = 4.5V, VOUT = 0.4V, VIL = 0V, (Note 2)	1	+25°C	12	-	mA
			2, 3	+125°C, -55°C	8	-	mA
Output Voltage High	VOH	VCC = 5.5V, VIH = 3.85V, VIL = 1.65V, IOH = -50μA	1, 2, 3	+25°C, +125°C, -55°C	VCC -0.1	-	V
		VCC = 4.5V, VIH = 3.15V, VIL = 1.35V, IOH = -50μA	1, 2, 3	+25°C, +125°C, -55°C	VCC -0.1	-	V
Output Voltage Low	VOL	VCC = 5.5V, VIH = 3.85V, VIL = 1.65V, IOL = 50μA	1, 2, 3	+25°C, +125°C, -55°C	-	0.1	V
		VCC = 4.5V, VIH = 3.15V, VIL = 1.35V, IOL = 50μA	1, 2, 3	+25°C, +125°C, -55°C	-	0.1	V
Input Leakage Current	IIN	VCC = 5.5V, VIN = VCC or GND	1	+25°C	-	±0.5	μA
			2, 3	+125°C, -55°C	-	±1.0	μA
Noise Immunity Functional Test	FN	VCC = 4.5V, VIH = 3.15V, VIL = 1.35V, (Note 3)	7, 8A, 8B	+25°C, +125°C, -55°C	-	-	V

NOTES:

1. All voltages referenced to device GND.
2. Force/Measure functions may be interchanged.
3. For functional tests, VO ≥4.0V is recognized as a logic "1", and VO ≤0.5V is recognized as a logic "0".

Specifications ACS20MS

TABLE 2. AC ELECTRICAL PERFORMANCE CHARACTERISTICS

PARAMETER	SYMBOL	(NOTES 1, 2) CONDITIONS	GROUP A SUB- GROUPS	TEMPERATURE	LIMITS		UNITS
					MIN	MAX	
Propagation Delay Input to Output	TPHL	VCC = 4.5V, VIH = 4.5V, VIL = 0V	9	+25°C	2	12	ns
	TPLH	VCC = 4.5V, VIH = 4.5V, VIL = 0V	10, 11	+125°C, -55°C	2	15	ns

NOTES:

1. All voltages referenced to device GND.
2. AC measurements assume RL = 500Ω, CL = 50pF, Input TR = TF = 3ns.

TABLE 3. ELECTRICAL PERFORMANCE CHARACTERISTICS

PARAMETER	SYMBOL	CONDITIONS	NOTE	TEMP	LIMITS			UNITS
					MIN	TYP	MAX	
Capacitance Power Dissipation	CPD	VCC = 5.0V, VIH = 5.0V, VIL = 0V, f = 1MHz	1	+25°C	-	18	-	pF
				+125°C	-	20	-	pF
Input Capacitance	CIN	VCC = 5.0V, VIH = 5.0V, VIL = 0V, f = 1MHz	1	+25°C	-	-	10	pF
				+125°C	-	-	10	pF

NOTE:

1. The parameters listed in Table 3 are controlled via design or process parameters. Min and Max Limits are guaranteed but not directly tested. These parameters are characterized upon initial design release and upon design changes which affect these characteristics.

TABLE 4. POST IRRADIATION ELECTRICAL PERFORMANCE CHARACTERISTICS

PARAMETER	SYMBOL	(NOTE 1) CONDITIONS	TEMPERATURE	RAD LIMITS		UNITS
				MIN	MAX	
Supply Current	ICC	VCC = 5.5V, VIN = VCC or GND	+25°C	-	100	μA
Output Current (Source)	IOH	VCC = VIH = 4.5V, VOUT = VCC - 0.4V, VIL = 0	+25°C	-8.0	-	mA
Output Current (Sink)	IOL	VCC = VIH = 4.5V, VOUT = 0.4V, VIL = 0	+25°C	8.0	-	mA
Output Voltage High	VOH	VCC = 5.5V, VIH = 3.85V, VIL = 1.65V, IOH = -50μA	+25°C	VCC - 0.1	-	V
		VCC = 4.5V, VIH = 3.15V, VIL = 1.35V, IOH = -50μA	+25°C	VCC - 0.1	-	V
Output Voltage Low	VOL	VCC = 5.5V, VIH = 3.85V, VIL = 1.65V, IOL = 50μA	+25°C	-	0.1	V
		VCC = 4.5V, VIH = 3.15V, VIL = 1.35V, IOL = 50μA	+25°C	-	0.1	V
Input Leakage Current	IIN	VCC = 5.5V, VIN = VCC or GND	+25°C	-	±1	μA
Noise Immunity Functional Test	FN	VCC = 4.5V, VIH = 3.15V, VIL = 1.35V, (Note 2)	+25°C	-	-	V
Propagation Delay Input to Output	TPHL TPLH	VCC = 4.5V, VIH = 4.5V, VIL = 0V	+25°C	2	15	ns

NOTES:

1. All voltages referenced to device GND.
2. For functional tests, VO ≥ 4.0V is recognized as a logic "1", and VO ≤ 0.5V is recognized as a logic "0".

TABLE 5. DELTA PARAMETERS (+25°C)

PARAMETER	SYMBOL	(NOTE 1) DELTA LIMIT	UNITS
Supply Current	ICC	±1.0	μA
Output Current	IOL/IOH	±15	%

NOTE:

1. All delta calculations are referenced to 0 hour readings or pre-life readings.

Specifications ACS20MS

TABLE 6. APPLICABLE SUBGROUPS

CONFORMANCE GROUPS		METHOD	GROUP A SUBGROUPS	READ AND RECORD
Initial Test (Preburn-In)		100%/5004	1, 7, 9	ICC, IOL/H
Interim Test 1 (Postburn-In)		100%/5004	1, 7, 9	ICC, IOL/H
Interim Test 2 (Postburn-In)		100%/5004	1, 7, 9	ICC, IOL/H
PDA		100%/5004	1, 7, 9, Deltas	
Interim Test 3 (Postburn-In)		100%/5004	1, 7, 9	ICC, IOL/H
PDA		100%/5004	1, 7, 9, Deltas	
Final Test		100%/5004	2, 3, 8A, 8B, 10, 11	
Group A (Note 1)		Sample/5005	1, 2, 3, 7, 8A, 8B, 9, 10, 11	
Group B	Subgroup B-5	Sample/5005	1, 2, 3, 7, 8A, 8B, 9, 10, 11, Deltas	Subgroups 1, 2, 3, 9, 10, 11
	Subgroup B-6	Sample/5005	1, 7, 9	
Group D		Sample/5005	1, 7, 9	

NOTE:

1. Alternate Group A testing may be exercised in accordance with MIL-STD-883, Method 5005.

TABLE 7. TOTAL DOSE IRRADIATION

CONFORMANCE GROUP	METHOD	TEST		READ AND RECORD	
		PRE RAD	POST RAD	PRE RAD	POST RAD
Group E Subgroup 2	5005	1, 7, 9	Table 4	1, 9	Table 4 (Note 1)

NOTE:

1. Except FN test which will be performed 100% Go/No-Go.

TABLE 8. BURN-IN TEST CONNECTIONS (+125°C < TA < 139°C)

OPEN	GROUND	1/2 VCC = 3V ±0.5V	VCC = 6V ±0.5V	OSCILLATOR	
				50kHz	25kHz
STATIC 1 BURN-IN (Notes 1, 2)					
-	1, 2, 4, 5, 7, 9, 10, 12, 13	3, 6, 8, 11	14	-	-
STATIC 2 BURN-IN (Notes 1, 2)					
-	7	3, 6, 8, 11	1, 2, 4, 5, 9, 10, 12, 13	-	-
DYNAMIC BURN-IN (Notes 1, 2)					
-	7	3, 6, 8, 11	14	1, 2, 4, 5, 9, 10, 12, 13	-

NOTES:

1. Each lead except VCC and GND will have a series resistor of 500Ω ±5%.
2. No-connect pins 3 and 11 may be connected to any voltage level.

TABLE 9. IRRADIATION TEST CONNECTIONS

FUNCTION	OPEN	GROUND	VCC = 5V ±0.5V
Irradiation Circuit (Note 1)	3, 6, 8, 11	7	1, 2, 4, 5, 9, 10, 11, 12, 13, 14

NOTE:

1. Each pin except VCC and GND will have a series resistor of 47kΩ ±5%. Group E, Subgroup 2, sample size is 4 dice/wafer, 0 failures.

Specifications ACS20MS

Intersil - Space Products MS Screening

Wafer Lot Acceptance (All Lots) Method 5007 (Includes SEM)	100% Static Burn-In 2 Method 1015, 24 Hours at +125°C Min
Radiation Verification (Each Wafer) Method 1019, 4 Samples/Wafer, 0 Rejects	100% Interim Electrical Test 2 (Note 1)
100% Nondestructive Bond Pull Method 2023	100% Dynamic Burn-In Method 1015, 240 Hours at +125°C or 180 Hours at +135°C
100% Internal Visual Inspection Method 2010	100% Interim Electrical Test 3 (Note 1)
100% Temperature Cycling Method 1010 Condition C (-65° to +150°C)	100% Final Electrical Test
100% Constant Acceleration	100% Fine and Gross Seal Method 1014
100% PIND Testing	100% Radiographics Method 2012 (2 Views)
100% External Visual Inspection	100% External Visual Method 2009
100% Serialization	Group A (All Tests) Method 5005 (Class S)
100% Initial Electrical Test	Group B (Optional) Method 5005 (Class S) (Note 2)
100% Static Burn-In 1 Method 1015, 24 Hours at +125°C Min	Group D (Optional) Method 5005 (Class S) (Note 2)
100% Interim Electrical Test 1 (Note 1)	CSI and/or GSI (Optional) (Note 2)
	Data Package Generation (Note 3)

NOTES:

- Failures from interim electrical tests 1 and 2 are combined for determining PDA (PDA = 5% for subgroups 1, 7, 9 and delta failures combined, PDA = 3% for subgroup 7 failures). Interim electrical tests 3 PDA (PDA = 5% for subgroups 1, 7, 9 and delta failures combined, PDA = 3% for subgroup 7 failures).
- These steps are optional, and should be listed on the purchase order if required.
- Data Package Contents:
 Cover Sheet (P.O. Number, Customer Number, Lot Date Code, Intersil Number, Lot Number, Quantity).
 Certificate of Conformance (as found on shipper).
 Lot Serial Number Sheet (Good Unit(s) Serial Number and Lot Number).
 Variables Data (All Read, Record, and delta operations).
 Group A Attributes Data Summary.
 Wafer Lot Acceptance Report (Method 5007) to include reproductions of SEM photos. NOTE: SEM photos to include percent of step coverage.
 X-Ray Report and Film, including penetrometer measurements.
 GAMMA Radiation Report with initial shipment of devices from the same wafer lot; containing a Cover Page, Disposition, RAD Dose, Lot Number, Test Package, Spec Number(s), Test Equipment, etc. Irradiation Read and Record data will be on file at Intersil.

Propagation Delay Timing Diagram and Load Circuit

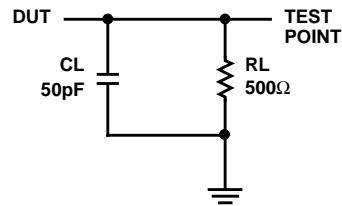
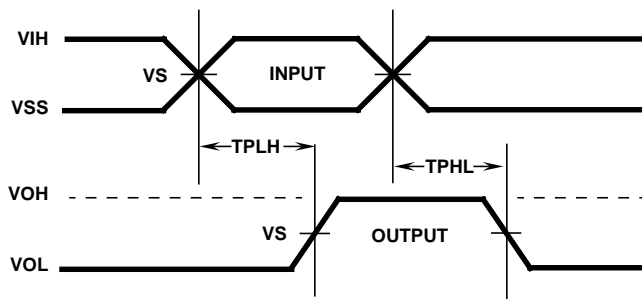

AC VOLTAGE LEVELS

PARAMETER	ACS	UNITS
VCC	4.50	V
VIH	4.50	V
VS	2.25	V
VIL	0	V
GND	0	V

ACS20MS

Die Characteristics

DIE DIMENSIONS:

88 mils x 88 mils
2,240mm x 2,240mm

METALLIZATION:

Type: AlSiCu
Metal 1 Thickness: 6.75kÅ (Min), 8.25kÅ (Max)
Metal 2 Thickness: 9kÅ (Min), 11kÅ (Max)

GLASSIVATION:

Type: SiO₂
Thickness: 8kÅ ±1kÅ

DIE ATTACH:

Material: Silver Glass or JM7000 Polymer after 7/1/95

WORST CASE CURRENT DENSITY:

< 2.0 x 10⁵ A/cm²

BOND PAD SIZE:

> 4.3 mils x 4.3 mils
> 110µm x 110µm

Metallization Mask Layout

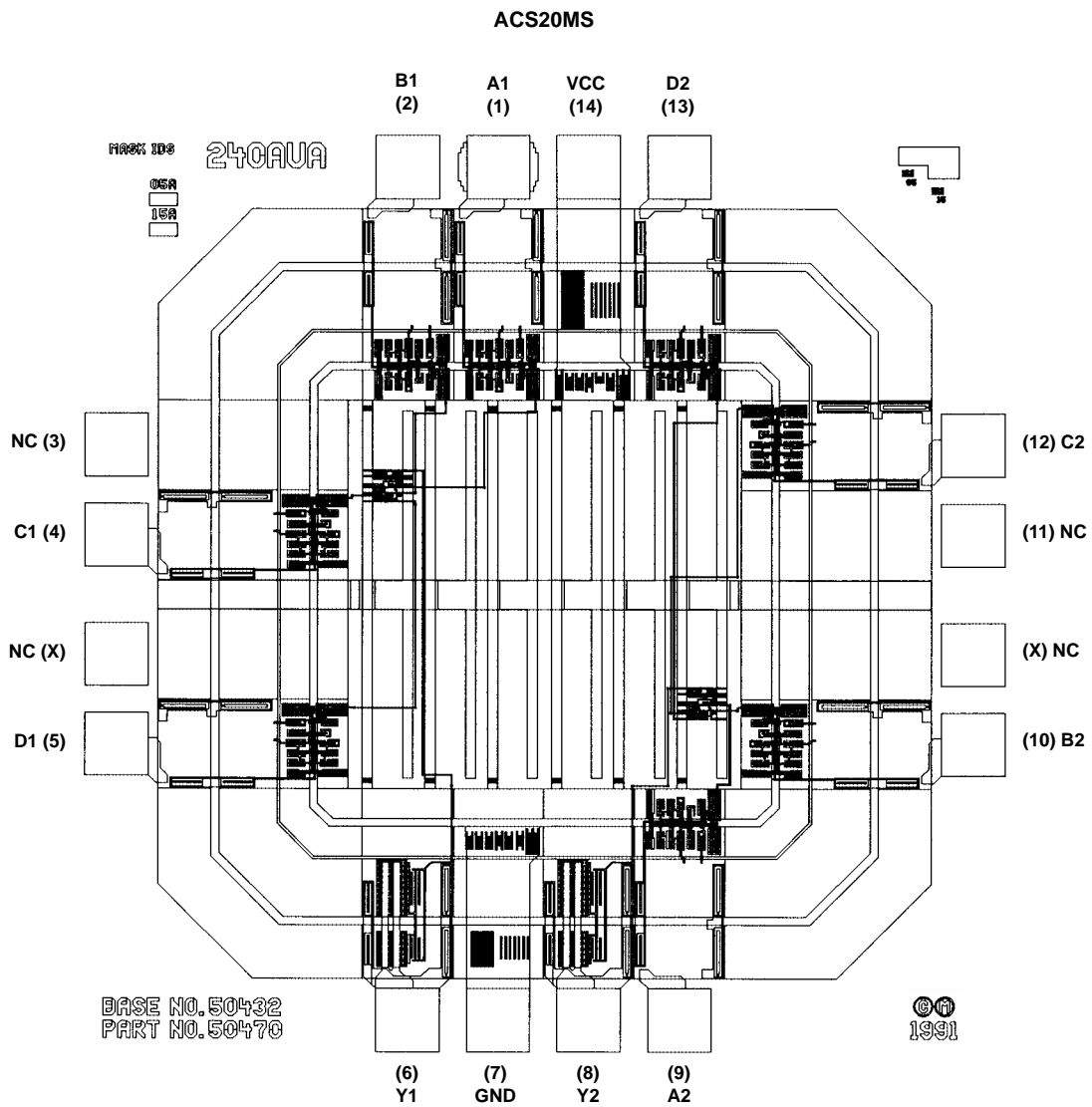

Ceramic Dual-In-Line Metal Seal Packages (SBDIP)

**D14.3 MIL-STD-1835 CDIP2-T14 (D-1, CONFIGURATION C)
14 LEAD CERAMIC DUAL-IN-LINE METAL SEAL PACKAGE**

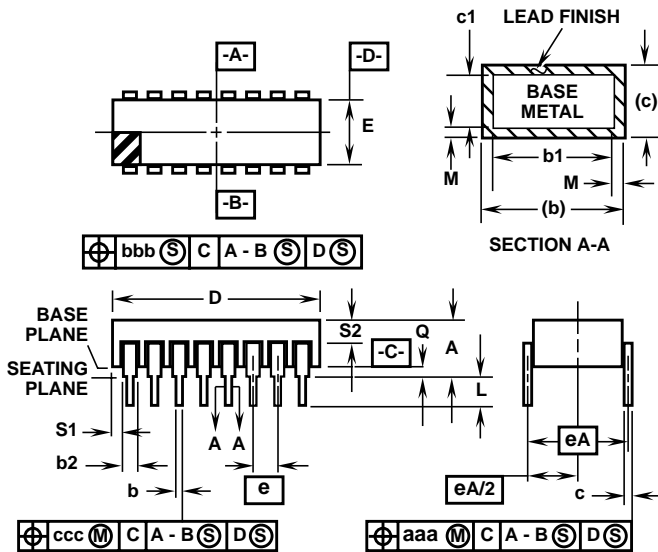

SYMBOL	INCHES		MILLIMETERS		NOTES
	MIN	MAX	MIN	MAX	
A	-	0.200	-	5.08	-
b	0.014	0.026	0.36	0.66	2
b1	0.014	0.023	0.36	0.58	3
b2	0.045	0.065	1.14	1.65	-
b3	0.023	0.045	0.58	1.14	4
c	0.008	0.018	0.20	0.46	2
c1	0.008	0.015	0.20	0.38	3
D	-	0.785	-	19.94	-
E	0.220	0.310	5.59	7.87	-
e	0.100 BSC		2.54 BSC		-
eA	0.300 BSC		7.62 BSC		-
eA/2	0.150 BSC		3.81 BSC		-
L	0.125	0.200	3.18	5.08	-
Q	0.015	0.060	0.38	1.52	5
S1	0.005	-	0.13	-	6
S2	0.005	-	0.13	-	7
α	90°	105°	90°	105°	-
aaa	-	0.015	-	0.38	-
bbb	-	0.030	-	0.76	-
ccc	-	0.010	-	0.25	-
M	-	0.0015	-	0.038	2
N	14		14		8

NOTES:

1. Index area: A notch or a pin one identification mark shall be located adjacent to pin one and shall be located within the shaded area shown. The manufacturer's identification shall not be used as a pin one identification mark.
2. The maximum limits of lead dimensions b and c or M shall be measured at the centroid of the finished lead surfaces, when solder dip or tin plate lead finish is applied.
3. Dimensions b1 and c1 apply to lead base metal only. Dimension M applies to lead plating and finish thickness.
4. Corner leads (1, N, N/2, and N/2+1) may be configured with a partial lead paddle. For this configuration dimension b3 replaces dimension b2.
5. Dimension Q shall be measured from the seating plane to the base plane.
6. Measure dimension S1 at all four corners.
7. Measure dimension S2 from the top of the ceramic body to the nearest metallization or lead.
8. N is the maximum number of terminal positions.
9. Braze fillets shall be concave.
10. Dimensioning and tolerancing per ANSI Y14.5M - 1982.
11. Controlling dimension: INCH.

Rev. 0 4/94

Ceramic Metal Seal Flatpack Packages (Flatpack)

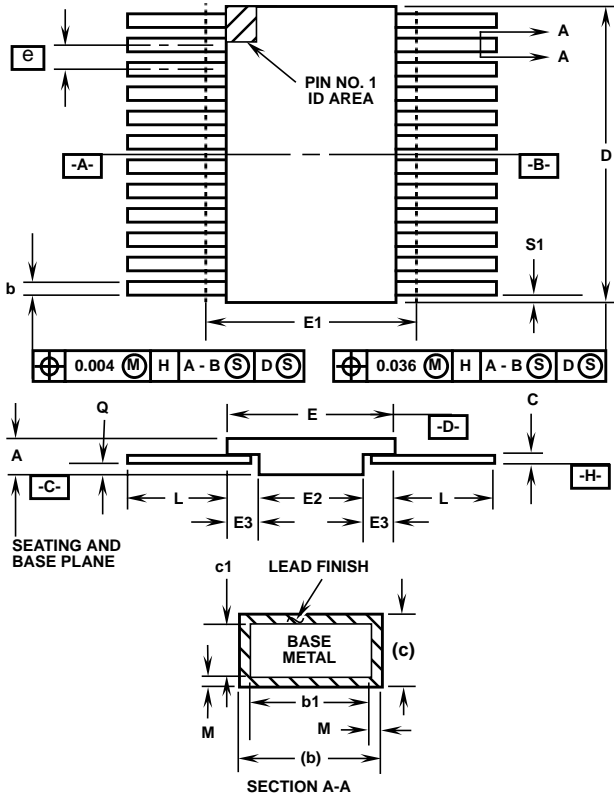

**K14.A MIL-STD-1835 CDFP3-F14 (F-2A, CONFIGURATION B)
14 LEAD CERAMIC METAL SEAL FLATPACK PACKAGE**

SYMBOL	INCHES		MILLIMETERS		NOTES
	MIN	MAX	MIN	MAX	
A	0.045	0.115	1.14	2.92	-
b	0.015	0.022	0.38	0.56	-
b1	0.015	0.019	0.38	0.48	-
c	0.004	0.009	0.10	0.23	-
c1	0.004	0.006	0.10	0.15	-
D	-	0.390	-	9.91	3
E	0.235	0.260	5.97	6.60	-
E1	-	0.290	-	7.11	3
E2	0.125	-	3.18	-	-
E3	0.030	-	0.76	-	7
e	0.050 BSC		1.27 BSC		-
k	0.008	0.015	0.20	0.38	2
L	0.270	0.370	6.86	9.40	-
Q	0.026	0.045	0.66	1.14	8
S1	0.005	-	0.13	-	6
M	-	0.0015	-	0.04	-
N	14		14		-

Rev. 0 5/18/94

NOTES:

1. Index area: A notch or a pin one identification mark shall be located adjacent to pin one and shall be located within the shaded area shown. The manufacturer's identification shall not be used as a pin one identification mark. Alternately, a tab (dimension k) may be used to identify pin one.
2. If a pin one identification mark is used in addition to a tab, the limits of dimension k do not apply.
3. This dimension allows for off-center lid, meniscus, and glass overrun.
4. Dimensions b1 and c1 apply to lead base metal only. Dimension M applies to lead plating and finish thickness. The maximum limits of lead dimensions b and c or M shall be measured at the centroid of the finished lead surfaces, when solder dip or tin plate lead finish is applied.
5. N is the maximum number of terminal positions.
6. Measure dimension S1 at all four corners.
7. For bottom-brazed lead packages, no organic or polymeric materials shall be molded to the bottom of the package to cover the leads.
8. Dimension Q shall be measured at the point of exit (beyond the meniscus) of the lead from the body. Dimension Q minimum shall be reduced by 0.0015 inch (0.038mm) maximum when solder dip lead finish is applied.
9. Dimensioning and tolerancing per ANSI Y14.5M - 1982.
10. Controlling dimension: INCH.

All Intersil semiconductor products are manufactured, assembled and tested under **ISO9000** quality systems certification.

Intersil products are sold by description only. Intersil Corporation reserves the right to make changes in circuit design and/or specifications at any time without notice. Accordingly, the reader is cautioned to verify that data sheets are current before placing orders. Information furnished by Intersil is believed to be accurate and reliable. However, no responsibility is assumed by Intersil or its subsidiaries for its use; nor for any infringements of patents or other rights of third parties which may result from its use. No license is granted by implication or otherwise under any patent or patent rights of Intersil or its subsidiaries.

For information regarding Intersil Corporation and its products, see web site <http://www.intersil.com>

Sales Office Headquarters

NORTH AMERICA
Intersil Corporation
P. O. Box 883, Mail Stop 53-204
Melbourne, FL 32902
TEL: (321) 724-7000
FAX: (321) 724-7240

EUROPE
Intersil SA
Mercure Center
100, Rue de la Fusee
1130 Brussels, Belgium
TEL: (32) 2.724.2111
FAX: (32) 2.724.22.05

ASIA
Intersil (Taiwan) Ltd.
Taiwan Limited
7F-6, No. 101 Fu Hsing North Road
Taipei, Taiwan
Republic of China
TEL: (886) 2 2716 9310
FAX: (886) 2 2715 3029