

Low-Noise Amplifier/Mixer

The HFA3600 is a silicon Low-Noise Amplifier with high performance characteristics allowing the design of very sensitive, wide dynamic-range 900MHz receivers with minimal external components.

The LNA, Mixer RF, and LO inputs are internally matched to 50Ω. The Mixer IF output is open collector allowing flexibility in choosing the IF output impedance, with 1000Ω operation fully characterized. The mixer performance is optimized for low LO drive (-3dBm) applications.

Power consumption is kept to a minimum, making the device ideal for battery-powered hand-held communication equipment. An integrated power-down feature maximizes battery life and eliminates the need for external shut down circuitry. Although fully characterized under 5V single supply, the HFA3600 is operable down to 4V with slight performance differences.

The HFA3600 is part of a complete solution including application circuit schematics, S-parameters, noise figure, third-order intercept characterization data and PC board artwork. Evaluation boards are also available through local Intersil Sales offices.

Ordering Information

PART NUMBER	TEMP. RANGE (°C)	PACKAGE	PKG. NO.
HFA3600IB	-40 to 85	14 Ld SOIC	M14.15
HFA3600IB96	-40 to 85	14 Ld SOIC in Tape and Reel	

Pinout

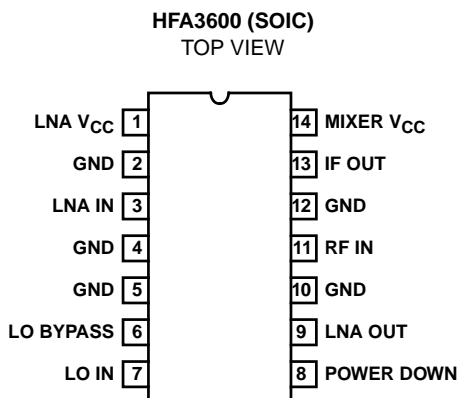

Features

- LNA
 - Low Noise Figure 2.3dB at 900MHz
 - High Power Gain 12.8dB at 900MHz
 - High Intercept +12.8dBm at Output
- MIXER
 - Low Noise Figure 12.1dB at 900MHz
 - High Power Gain 7.0dB at 900MHz
 - High Intercept +3.2dBm at Output
 - Low LO Drive - 3dBm
- LNA + MIXER
 - Low Noise Figure 3.97dB at 900MHz
 - High Power Gain 19.8dB at 900MHz
 - High Intercept -16.7dBm at Input
 - Low Operating Power 5V/11.3mA
 - Low Shutdown Power 5V/250μA
 - Small Package: 14 Lead SOIC (Plastic, Small Outline Package, 150 Mil Width, 50 Mil Lead Spacing)

Applications

- Portable Cellular Telephone (AMPS, IS-54, GSM, JDC)
- Wireless Data Com. (ISM, Narrowband PCS)
- UHF and Mobile Radio Receiver
- 900MHz Digital Cordless Telephone (CT-2, ISM)
- Wireless Telemetry

Block Diagram

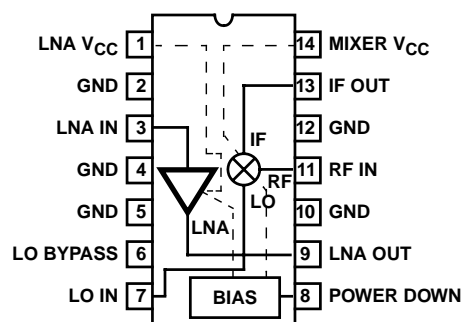

Absolute Maximum Ratings

Supply Voltage	-0.3 to +6.0V
Voltage on Any Other Pin	-0.3 to V _{CC} +0.3V
V _{CC} to V _{CC} Decouple	-0.3 to +0.3V
Any GND to GND	-0.3 to +0.3V

Operating Conditions

Temperature Range	-40°C ≤ T _A ≤ 85°C
Supply Voltage Range	4.0 to 5.5V

Thermal Information

Thermal Resistance (Typical, Note 1)	θ _{JA} (°C/W)
SOIC Package	125
Maximum Package Power Dissipation at 25°C	1W
Maximum Junction Temperature (Plastic Package)	150°C
Maximum Storage Temperature Range	-65°C ≤ T _A ≤ 150°C
Maximum Lead Temperature (Soldering 10s) (Lead Tips Only)	300°C

CAUTION: Stresses above those listed in "Absolute Maximum Ratings" may cause permanent damage to the device. This is a stress only rating and operation of the device at these or any other conditions above those indicated in the operational sections of this specification is not implied.

NOTE:

1. θ_{JA} is measured with the component mounted on an evaluation PC board in free air.

DC Electrical Specifications

SYMBOL	PARAMETER	CONDITION	TEST LEVEL	TEMP (°C)	ALL GRADES			UNITS
					MIN	TYP	MAX	
I _{CC}	Total Supply Current at 5V	Normal PD = 2V	A	25	-	11.3	12.5	mA
		Shutdown PD = 0.8V	A	25	-	250	375	µA
V _{IH}	Shutdown Logic High	Normal Mode	A	25	2	-	V _{CC}	V
V _{IL}	Shutdown Logic Low	Shutdown Mode	A	25	-0.3	-	0.8	V
I _{IL}	Shutdown Input Current	PD = 0.4V	A	25	-200	-150	-100	µA
I _{IH}	Shutdown Input Current	PD = 2.4V	A	25	-45	-24	-3	µA
V _{LNA-IN}	LNA Input DC Level	Normal Mode	A	25	-	0.79	-	V
		Shutdown Mode	A	25	-	0.0	-	V
V _{LNA-OUT}	LNA Output DC Level	Normal Mode	A	25	-	4.9	-	V
		Shutdown Mode	A	25	-	5.0	-	V
V _{MX-RF}	Mixer RFIN DC Level	Normal Mode	A	25	-	0.79	-	V
		Shutdown Mode	A	25	-	0.0	-	V
V _{MX-LO}	Mixer LO _{IN} DC Level	Normal Mode	A	25	-	2.1	-	V
		Shutdown Mode	A	25	-	0.0	-	V
t _{OFF, ON}	Shutdown On-Off-On Time		B	25	-	10	-	µs

AC Electrical Specifications

All Characterization Results have been Obtained with the Use of a Standard Evaluation Board.

SYMBOL	PARAMETER	TEST LEVEL	TEMP (°C)	ALL GRADES			UNITS
				MIN	TYP	MAX	
LNA (V _{CC} = +5V, T _A = 25°C, Test Figure 1 and f = 900MHz Unless Otherwise Noted In Characterization Curves)							
S _{21LNA}	LNA Gain	B	25	11.8	12.8	13.8	dB
S _{12LNA}	LNA Reverse Isolation	B	25	-	23	-	dB
S _{11LNA}	LNA Input Return Loss	B	25	6.0	7.3	-	dB
S _{22LNA}	LNA Output Return Loss	B	25	10.0	13.0	-	dB
P _{-1dB} LNA	LNA Output 1-dB Gain Compression Point	B	25	-	-2.0	-	dBm
IP _{3LNA}	LNA Output 3rd-Order Intercept	B	25	+11.2	+12.8	-	dBm
NF _{LNA}	LNA Noise Figure	B	25	-	2.30	2.60	dB

AC Electrical Specifications All Characterization Results have been Obtained with the Use of a Standard Evaluation Board. **(Continued)**

SYMBOL	PARAMETER	TEST LEVEL	TEMP (°C)	ALL GRADES			UNITS
				MIN	TYP	MAX	
MIXER ($V_{CC} = 5V$, $T_A = 25^{\circ}C$, $f_{LO} = 825MHz$ at $-3dBm$, $f_{RF} = 900MHz$, $f_{IF} = 75MHz$ and Test Figure 1, Unless Otherwise Noted)							
PG_C	MIXER Power Conversion Gain	B	25	5.9	7.0	8.1	dB
S_{11RF}	MIXER RF Input Return Loss	B	25	8.0	11.0	-	-
S_{11LO}	MIXER LO Input Return Loss	B	25	18.0	26	-	dB
NF_{MIXER}	MIXER SSB Noise Figure	B	25	-	12.1	13.9	dB
$P_{-1dB MIX}$	MIXER Output 1-dB Gain Compression	B	25	-	-7.5	-	dBm
IP_{3MIX}	MIXER Output 3rd-Order Intercept	B	25	+1.0	+3.2	-	dBm
C_{OUTMIX}	MIXER IF Output Capacitance	B	25	-	2.3	-	pF
G_{RF-IF}	MIXER RF-IF Isolation (Includes Matching Network)	B	25	-	25	-	dB
G_{LO-IF}	MIXER LO-IF Isolation (Includes Matching Network)	B	25	-	16	-	dB
G_{LO-RF}	MIXER LO-RF Isolation	B	25	16	21	-	dB
$G_{LO-LNAIN}$	Mixer LO-LNA _{IN} Isolation	B	25	42	50	-	dB
$G_{LNAOUT-RF}$	LNAOUT-Mixer RFIN Isolation	B	25	35	40	-	dB
(LNA + MIXER) $V_{CC} = 5V$, $T_A = 25^{\circ}C$, $f_{LO} = 825MHz$ at $-3dBm$, $f_{RF} = 900MHz$, $f_{IF} = 75MHz$ and Idealized Lossless External Filters							
CPG_C	Power Conversion Gain	B	25	-	19.8	-	dB
CNF	Noise Figure	B	25	-	3.97	-	dB
CIP_3	Input 3rd-Order Intercept	B	25	-	-16.7	-	dBm

NOTE: Test Level: A. Production Tested. B. Guaranteed Limit or Typical Based on Characterization.

Test Circuits

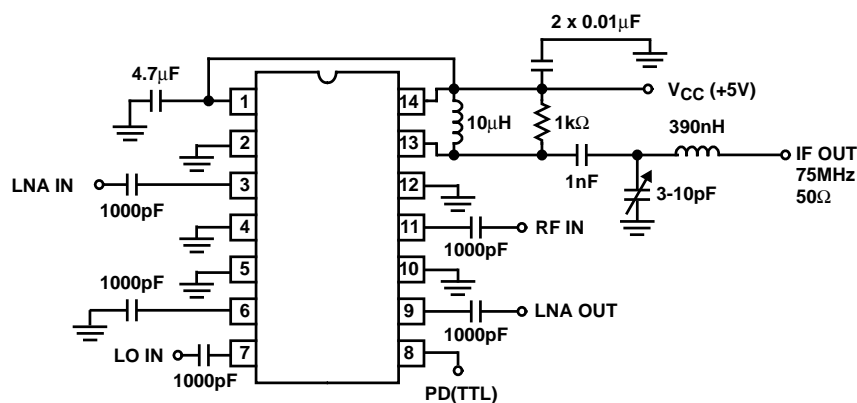

FIGURE 1. EVALUATION TEST CIRCUIT

Test Circuits (Continued)

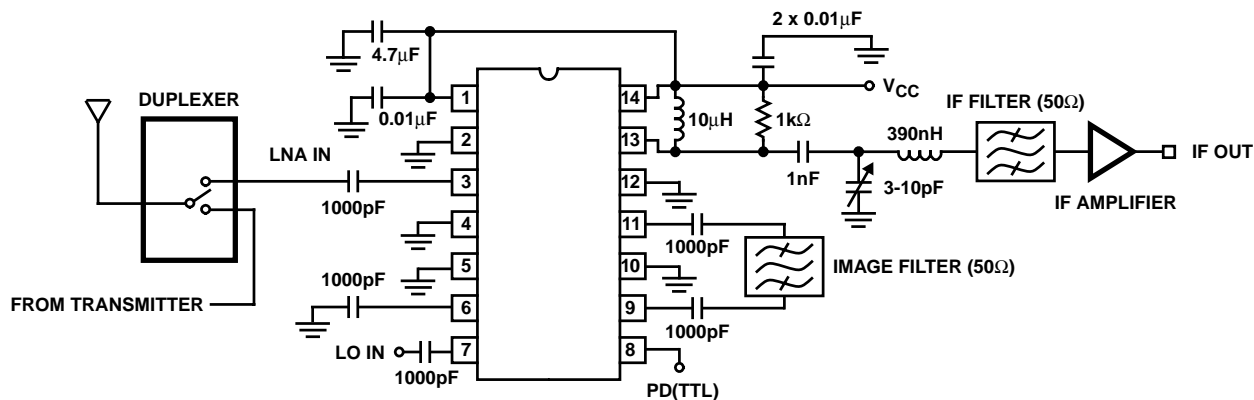

FIGURE 2. TYPICAL APPLICATION CIRCUIT

TABLE 1. TYPICAL CELLULAR FRONT-END CASCADED PERFORMANCE

	DUPLEXER	LNA	IMAGE FILTER	MIXER	IF FILTER	IF AMP	UNITS
Noise Figure	3.0	2.3	3.0	12.1	8.0	3.0	dB
Gain	-3.0	12.8	-3.0	7.0	-8.0	20.0	dB
OUTPUT IP3	100.0	12.8	100.0	3.2	Not Applicable (Note)		dBm
Cascaded Noise Figure = 8.55dB			Cascaded Gain = 25.8dB			Input IP3 = -10.8dBm	

NOTE: Cascaded results are using 100.0dBm for IP3.

Supply Characteristics

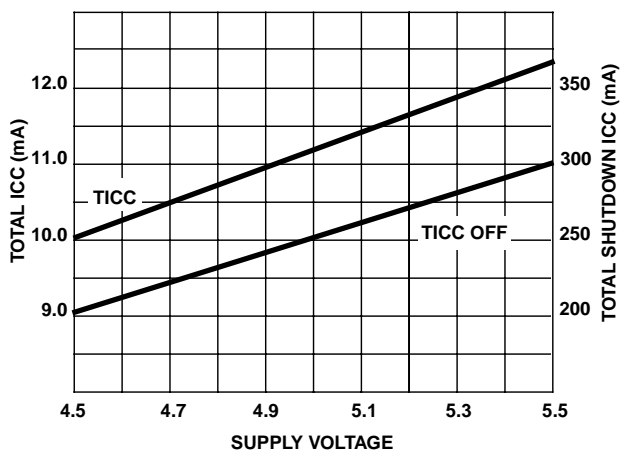

FIGURE 3. TOTAL ICC vs SUPPLY VOLTAGE

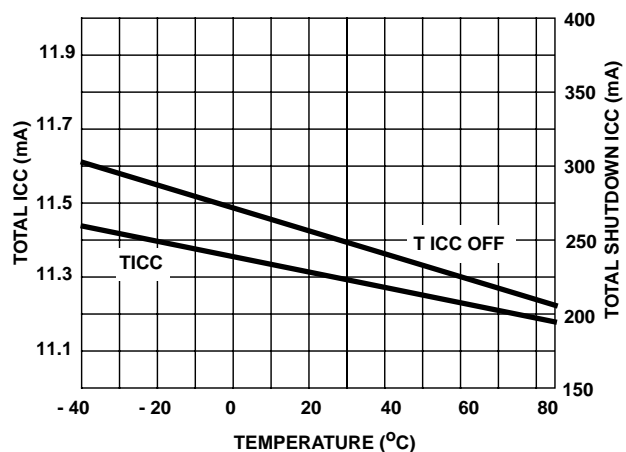

FIGURE 4. TOTAL ICC vs TEMPERATURE

LNA Characteristics

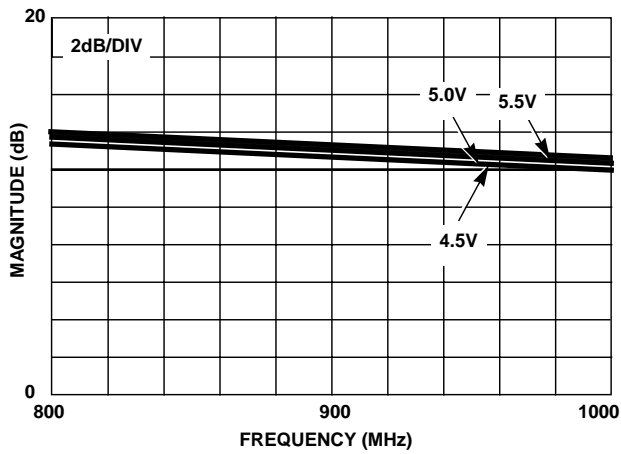

FIGURE 5. LNA S21 vs FREQUENCY AND V_{CC}

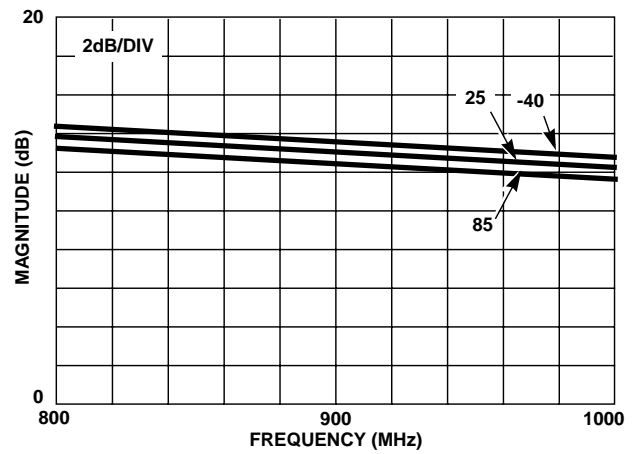

FIGURE 6. LNA S21 vs FREQUENCY AND TEMPERATURE

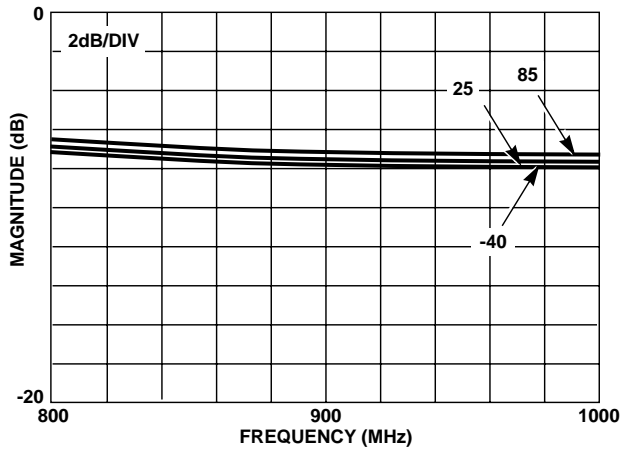

FIGURE 7. LNA S11 vs FREQUENCY AND TEMPERATURE

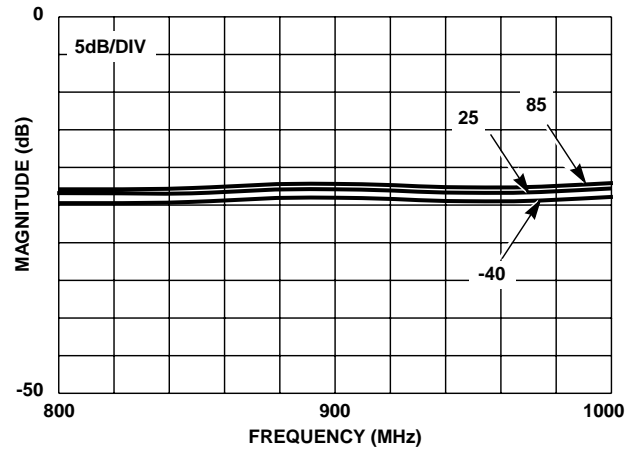

FIGURE 8. LNA S12 vs FREQUENCY AND TEMPERATURE

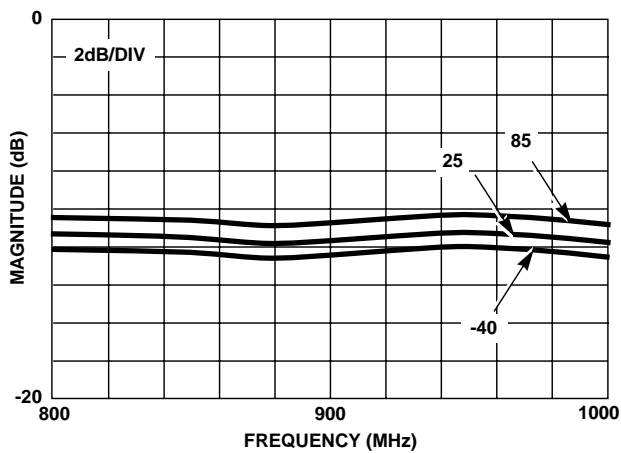

FIGURE 9. LNA S22 vs FREQUENCY AND TEMPERATURE

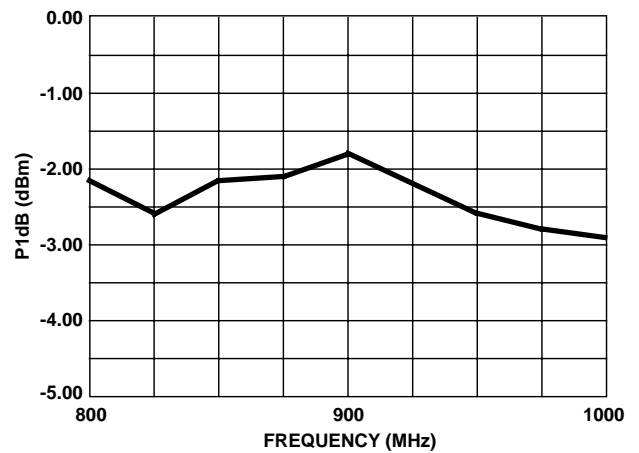

FIGURE 10. LNA OUTPUT 1dB COMPRESSION vs FREQUENCY

LNA Characteristics (Continued)

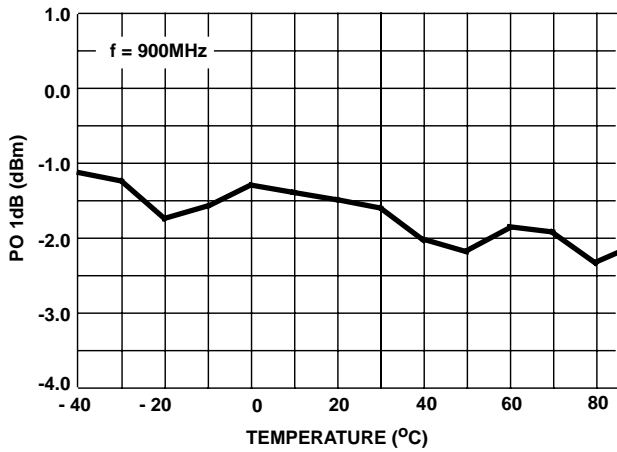

FIGURE 11. LNA OUTPUT 1DB COMPRESSION vs TEMPERATURE

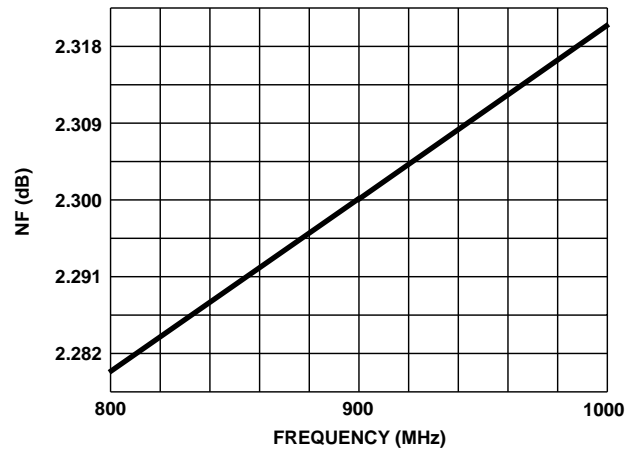

FIGURE 12. LNA 50Ω NF vs FREQUENCY

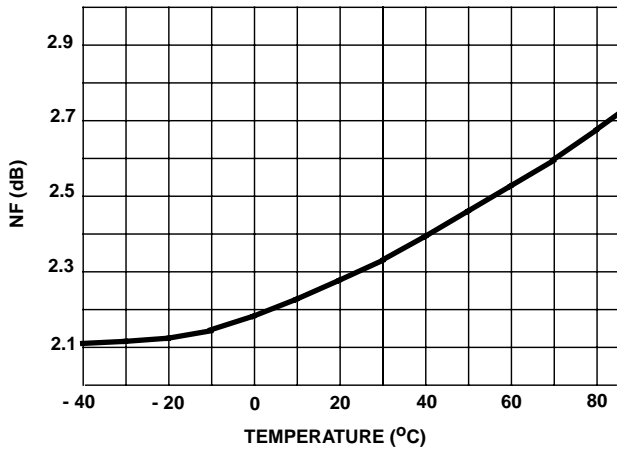

FIGURE 13. LNA 50Ω NF vs TEMPERATURE

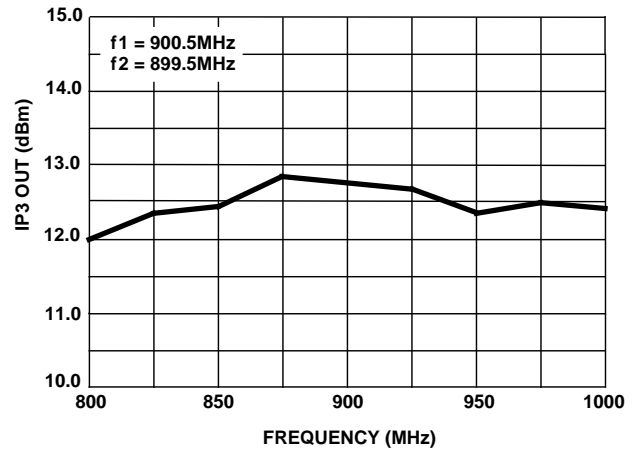

FIGURE 14. LNA OUTPUT IP3 vs FREQUENCY

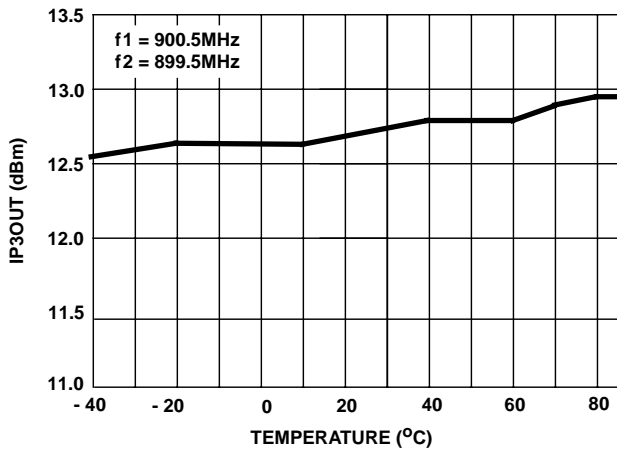

FIGURE 15. LNA OUTPUT IP3 vs TEMPERATURE

FREQ MHz	S11		S21		S22		S12	
	dB	DEG	dB	DEG	dB	DEG	dB	DEG
800	-6.7	153	13.7	11.4	-11.9	-170	-23.8	-41
850	-7.0	143	13.3	1.5	-12.0	171	-23.1	-48
900	-7.3	133	12.8	-7.7	-13.0	155	-23.0	-56
950	-7.4	123	12.6	-18	-12.0	137	-23.1	-65
1000	-7.6	113	12.2	-27	-11.8	120	-22.8	-70

FIGURE 16. LNA S-PARAMETERS

Mixer Characteristics

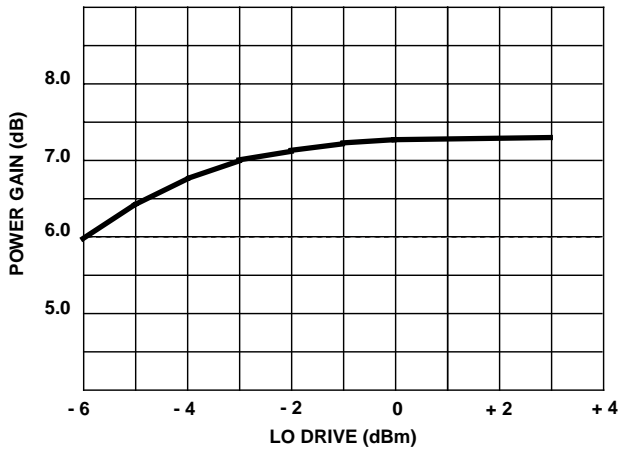

FIGURE 17. MIXER PG vs LO DRIVE

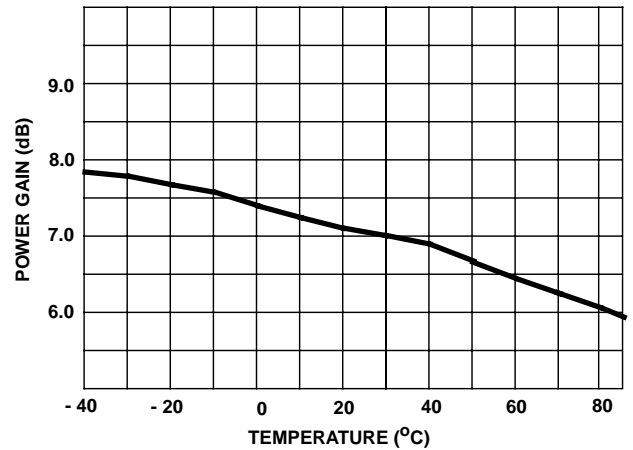

FIGURE 18. MIXER PG vs TEMPERATURE

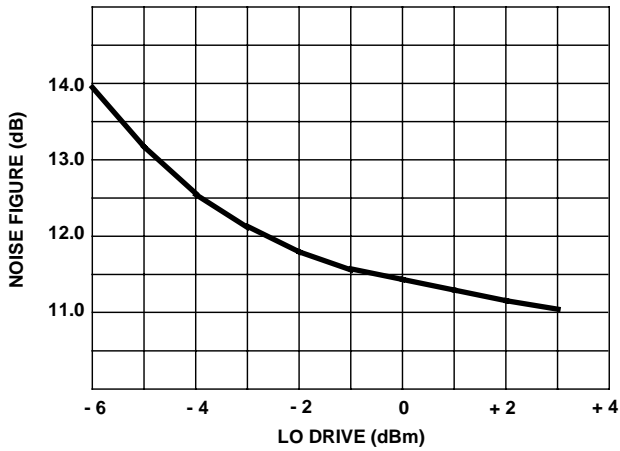

FIGURE 19. MIXER NF vs LO DRIVE

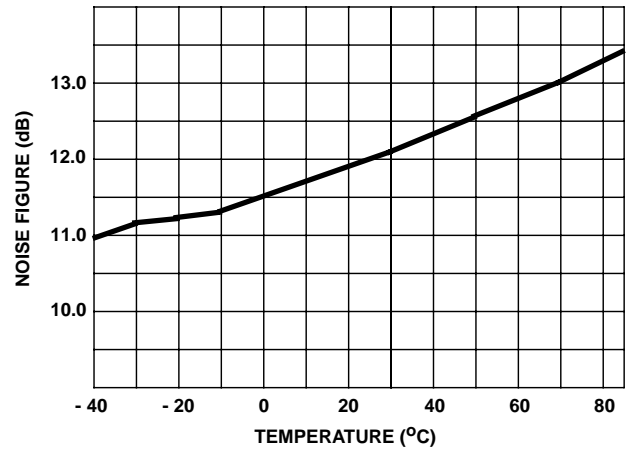

FIGURE 20. MIXER NF vs TEMPERATURE

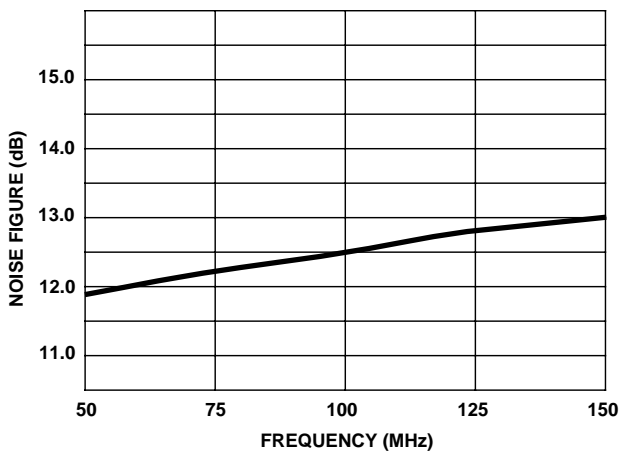

FIGURE 21. MIXER NF vs IF FREQUENCY, RF = 900MHz, FLO < FRF

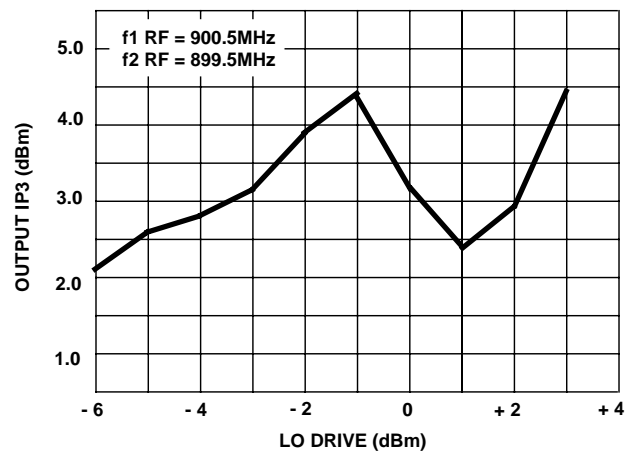

FIGURE 22. MIXER OUTPUT IP3 vs LO DRIVE

Mixer Characteristics (Continued)

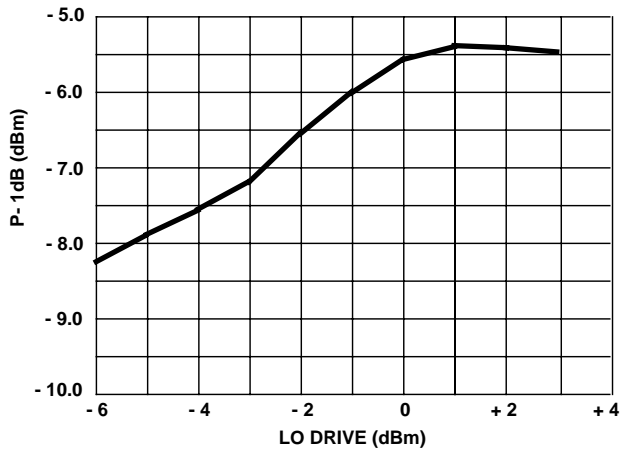

FIGURE 23. MIXER 1dB COMPRESSION vs LO DRIVE

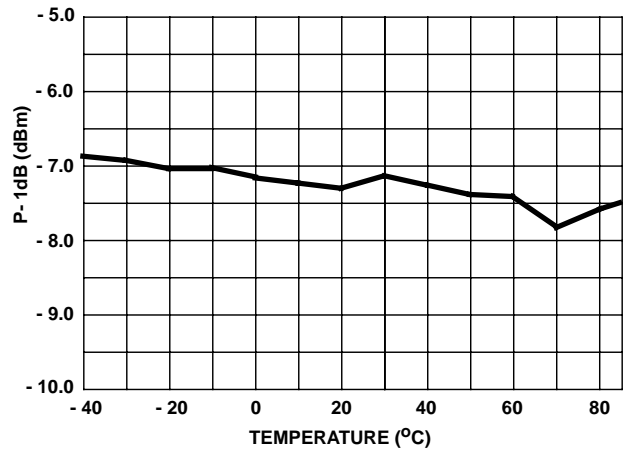

FIGURE 24. MIXER 1dB COMPRESSION vs TEMPERATURE

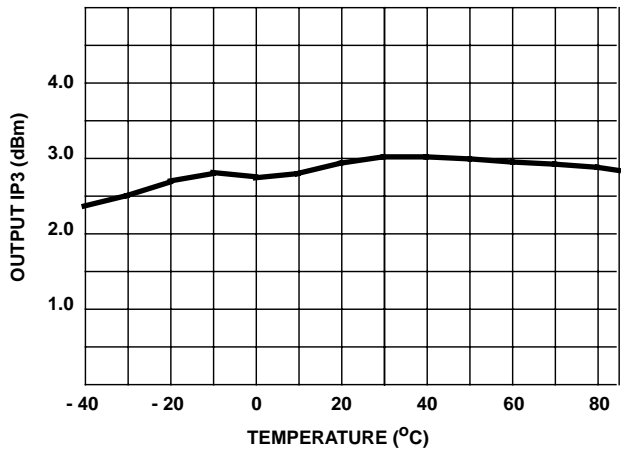

FIGURE 25. MIXER OUTPUT IP3 vs TEMPERATURE

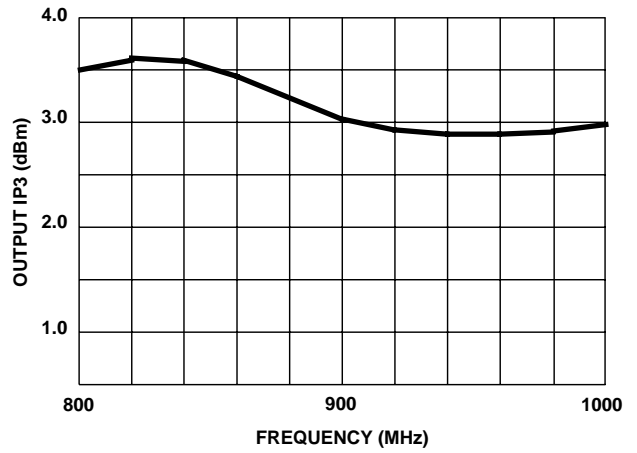

FIGURE 26. MIXER OUTPUT IP3 vs RF FREQUENCY

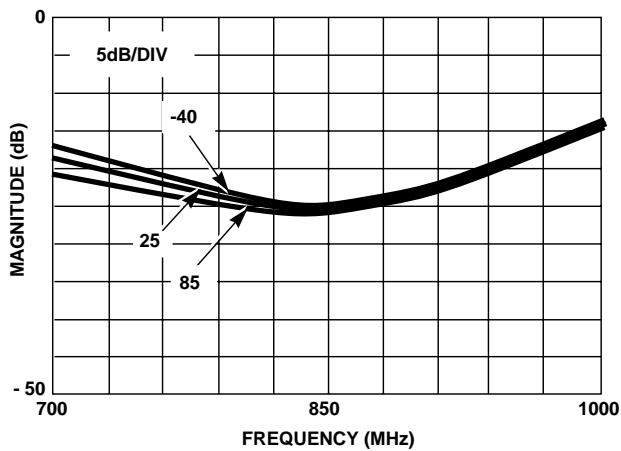

FIGURE 27. MIXER LO S11 vs FREQUENCY AND TEMPERATURE

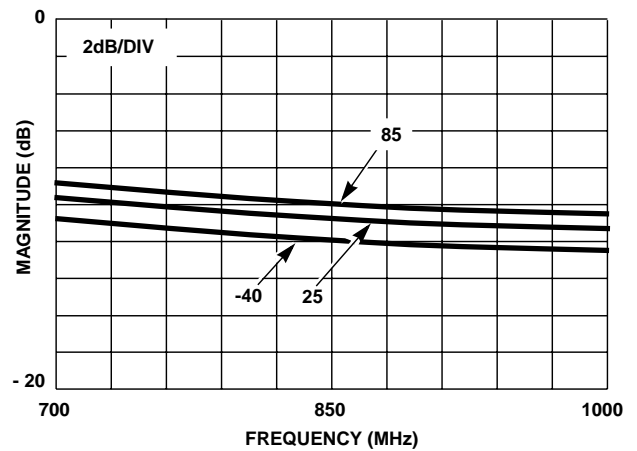

FIGURE 28. MIXER RF S11 vs FREQUENCY AND TEMPERATURE

Isolation Characteristics

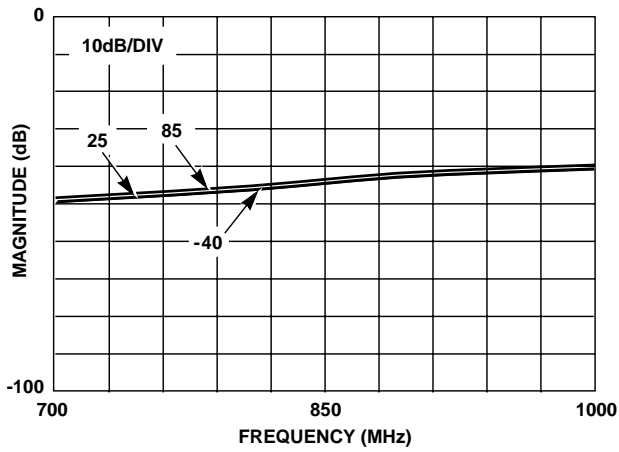

FIGURE 29. LNA OUT TO MIXER RF ISOLATION vs FREQUENCY AND TEMPERATURE

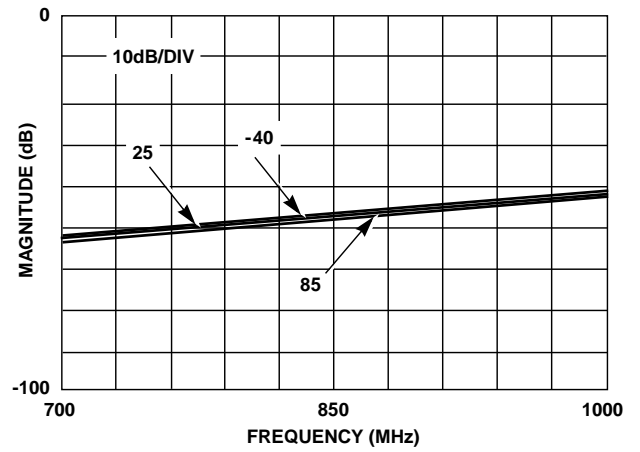

FIGURE 30. MIXER LO IN TO LNA IN ISOLATION vs FREQUENCY AND TEMPERATURE

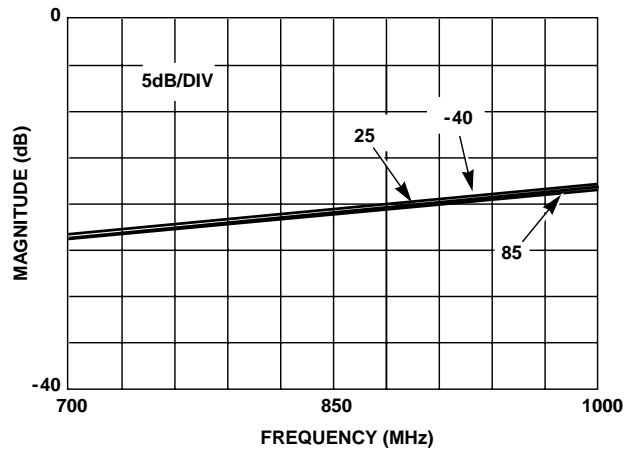

FIGURE 31. MIXER LO TO RF ISOLATION vs FREQUENCY AND TEMPERATURE

LNA Noise and Gain Characteristics

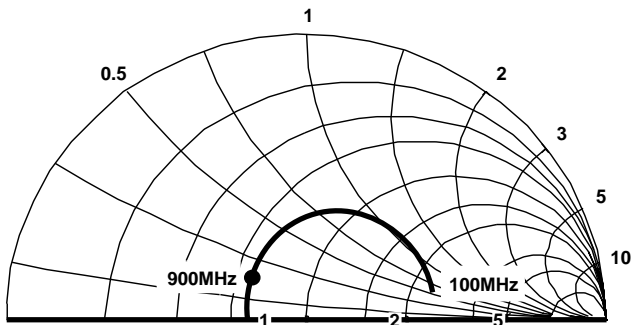

FIGURE 32. LNA GAMMA OPTIMUM vs FREQUENCY

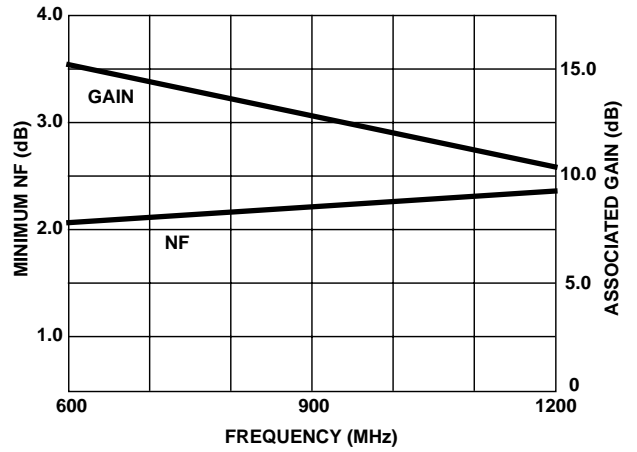

FIGURE 33. MINIMUM NOISE FIGURE AND ASSOCIATED GAIN vs FREQUENCY

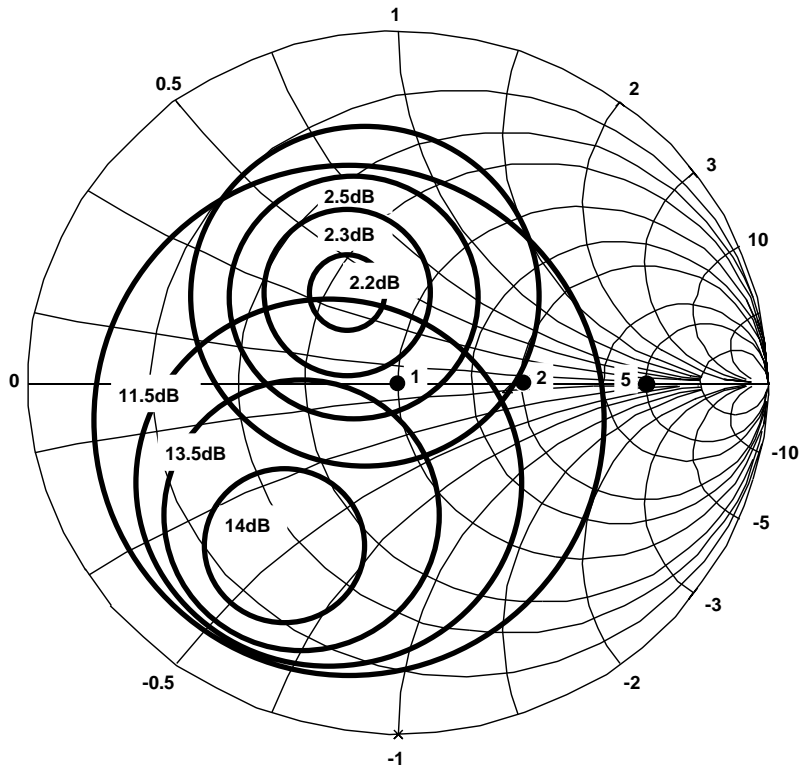

FIGURE 34. LNA NOISE AND GAIN CIRCLES AT 900MHz

Evaluation Board Layout Information

Component List:

R1 Res, fixed 1k Ω

L1 Ind., fixed 10 μ H

L2 Ind., fixed 390nH

C3, C4, C5, C7, C10, C11 Cap, fixed 1nF

C1, C6 Cap, fixed 0.01 μ F

C2 Cap, fixed Tantalum. 4.7 μ F

C8 Cap, var. 3pF to 10pF

Cr1 Diode DL4001

**EVALUATION BOARD LAYOUT SCALE X1
TOP VIEW**

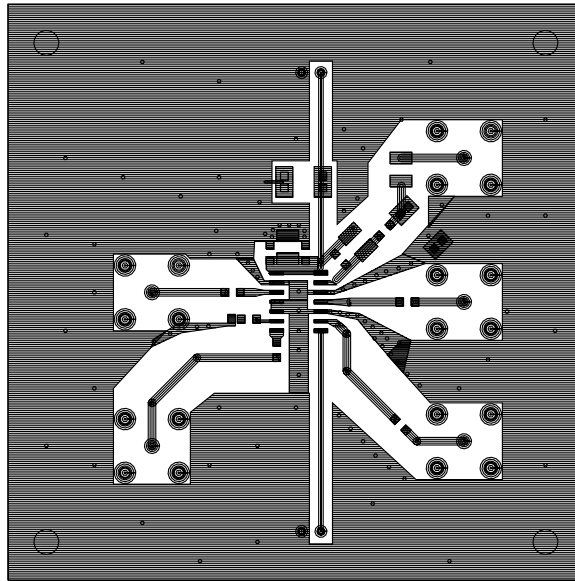

EVALUATION BOARD COMPONENT PLACEMENT

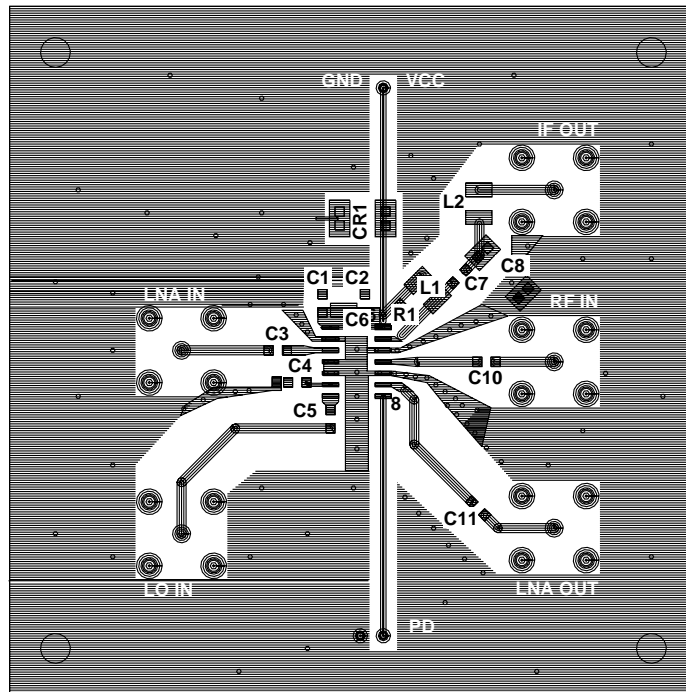

NOTE: See Evaluation Board testing information.

Pin Description

LNA V_{CC}

Supply voltage for the Low Noise amplifier.

LNA In

LNA input. Requires AC coupling. Minimum coupling capacitor value of 100pF is suggested. This input is optimized for 50W match in the 800MHz to 1000MHz range.

LO Bypass

Mixer LO Bypass. Capacitor required to assure a good AC ground. Placement is critical. The bypass capacitance should be located close to the device with low ground impedance. Minimum coupling capacitor value of 100pF is suggested.

LO In

Local oscillator input. Requires AC coupling. Input is optimized for 50W match in the 700MHz to 1000MHz range. Minimum coupling capacitor value of 100pF is suggested.

Power Down

Power down control with internal pull up. A low TTL or CMOS level disables the bias network, shutting down both the LNA and the MIXER within 10ms. The internal pull up is provided for users that do not require the power down feature. Provided for Time Division Multiplex Systems and/or power savings.

LNA Out

Output of the LNA. Requires AC coupling. This output has been optimized for 50W match in the 800MHz to 1000MHz range. Minimum coupling capacitor value of 100pF is suggested.

RF In

RF input to the MIXER. Requires AC coupling. Input optimized for 50W match in the 800MHz to 1000MHz range. Minimum coupling capacitor value of 100pF is suggested.

IF Out

Open collector output of the MIXER. Output capacitance is 2.3pF typical. The use of a RF choke maximizes the voltage output swing but is not mandatory. An output resistance controls the conversion gain as well as IP3 within the useful range of 300W to 1500W. It also affects the output impedance required for the next filter stage and facilitates any output matching network design requirements. Conversion gain is reduced upon use of low value resistors.

Mixer V_{CC}

Supply voltage for the MIXER and the Bias Network.

Characterization Information

The curves and data depicted in the Specifications Section are the result of the design characterization performed by the use of a standard evaluation board and a statistically significant sample procedure which reflects the INTERSIL UHF-1 process variation.

The use of standard RF techniques have been employed throughout the characterization process with special emphasis on noise figures, gains and LO level performances.

Special attention has been given to the Local oscillator signal purity and integrity throughout the low and high frequency spectrum.

The use of low Excess Noise Ratio (ENR) noise sources have been employed to guarantee a good 50Ω noise source output impedance during the LNA noise measurements.

The use of attenuators for most of the setups have assured output impedances of signals closer to 50W when the use of power splitters and filters with poor return loss were necessary.

50Ω environment measurements have been carried throughout the characterization process including the IF output from the MIXER.

Device Description

The HFA3600 is fabricated in the INTERSIL UHF-1 Bonded wafer, Silicon on Insulator process. It characteristics of 10GHz and Power bandwidth product of 6GHz together with the robustness of the SOI process ensure high reliability for high frequency volume production. The process features low parasitic capacitances and very low leakages.

LNA

The LNA uses a single stage topology with a collector spiral inductor to improve the stability at lower frequencies and to optimize the power gain in the 900MHz range. Typical noise figure of 2.3dB, gain of 12.8dB and third order output intercept point of +12.8dBm are the main features. Bias currents are laser trimmed for optimum performances and for tight distribution among production lots. Under a 50Ω environment, the LNA input return loss is 7.3dB and the output return loss is 13dB. Characteristics of the gamma optimum, which is shown in the specifications section, suggests that the optimum source impedance driving the LNA for minimum noise figure is located close to 50Ω. The trade-off between gain and noise figures at 900MHz are shown in the gain and noise circles representation of the specification section.

Mixer

The HFA3600 Mixer uses a single balanced topology. This topology features an open collector with an output capacitance in the order of 2.3pF. Bias settings are also laser trimmed for

optimum performance and tight distribution among production lots. The open collector output permits direct interface to moderate impedance IF filters as well as 50W input filters after a simple "L" impedance matching network. A collector resistor of 1K has been used throughout the characterization together with an impedance matching network for 50W load measurements. With a low -3dBm LO level, a typical SSB noise figure of 12.1dB, conversion gain of 7.0dB and a third order output intercept point of +3.2dBm are the main features. The LO input return loss is typically of 26dBm and the RF input return loss has a typical value of 11dB.

Bias Network and Power Down

The Bias Network is responsible for the accurate setting of both LNA and MIXER operating currents. The LNA operating current is accurately set to 5mA while the MIXER is set to 4mA. Laser trimming procedures and a temperature independent performance of the bias cell, assure the worst case operating current variation of the LNA and MIXER of 1% over the operating temperature range.

The Bias network is powered by the Mixer V_{CC} pin and has a built in feature of disabling both the LNA and the MIXER stages. The cell can be powered up and down within 10ms. Power down total current consumption is in the order of 250mA. The simplified schematic of the power down input circuit is shown below.

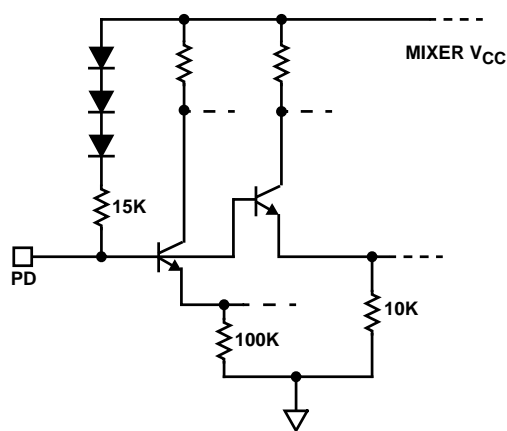

FIGURE 35. ENABLE PIN INPUT CIRCUIT

Low Voltage Operation

Low voltage operation is possible with the HFA3600. The HFA3600 has been characterized with V_{CC} of 4V and only moderate degradations have been observed compared to the AC performance at a V_{CC} of 5V. The LNA gain shows a 0.8dB decrease and a 1.5dB degradation in the output intercept point with no measurable impact on noise figure.

The MIXER behavior at 4V can be summarized with a degradation of conversion gain and output intercept point of 0.8dB and a slight improvement in noise figure of 0.6dB.

Other relevant 4V performance characteristics include:

- Total ICC: typical drop of 2.2mA
- LNA Input Return Loss: degraded by 0.6dB
- LNA Reverse Isolation: degraded by 1dB
- LNA Output Return Loss: degraded by 1dB
- RF to IF Isolation: no change
- LOin to LNAin Isolation: improvement by 2dB
- LNAOUT to Mixer RFIN Isolation: improvement by 0.2dB
- Mixer LO to RF Isolation: no change
- Mixer LO to IF Isolation: degrades by 0.5dB
- Mixer RF input Return Loss: degrades by 1dB
- Mixer LO Input Return Loss: degrades by 0.3dB at 800MHz and 1dB at 700MHz

Layout Considerations

The HFA3600 evaluation board layout has been carefully designed for an accurate RF characterization of the device. 50Ω microstrip lines have been provided to permit the connection of the LNA and MIXER independently and facilitate the user interface for testing. Top ground planes were used to assure adequate isolation between critical traces.

The HA3600 package pinout has been laid out for best isolation and overall device performance which also permits the placement and connection of ground planes at pins 2, 4, 5, 10 and 12. Pin 4 and Pin 5 assure a low impedance ground return for the LNA and also helps the isolation between the LNA input and the LO input. The LNA output pin is isolated from the RF input port with a good ground connection between the top and back ground planes terminated at pin 10. A series of plated through holes resembling a stitch pattern are sufficient and important for the LNA_{OUT} and RF_{IN} ports isolation, so the designer can rely on the full characteristics of rejection of the image filter. Similar isolation pattern is drawn and terminated in pin 12 to isolate the RF_{IN} from the IF_{OUT} port.

A ground pad has been laid down beneath the package with a series of plated through holes to minimize the inductance to the ground plane and improve the device gain characteristics.

All device grounds must be connected as close to the package as possible and the same applies to both V_{CC} inputs and all V_{CC} bypass capacitors. A small 4.7μF tantalum capacitor at the V_{CC} line will prevent supply coupling to the bias network if the device is subjected to strong low frequency interference signals.

A protection diode has been added to the demonstration board for extra protection and is not needed in an actual application.

Evaluation Board Testing Information

The following paragraphs contain information related to the evaluation of the HFA3600 LNA/Mixer noise figure and common errors encountered during individual and cascaded performance verification. A simple cascaded arrangement using a simple Π network as an intermediate filter is included.

Background

Active single balanced mixers are low cost, low power dissipation devices which require low local oscillator levels to operate. As single balanced mixers lack high isolation from the RF and LO input ports to the IF output and operate with moderate feedthrough from the LO input to the RF input, special precautions must be taken when evaluating these devices with test set ups, specifically filtering, and cabling hook ups. These constraints, although important during the evaluation of the device, are not major issues in the design of the overall system.

Poor isolation from the RF input to the IF output results in direct amplification (not only frequency translation) of undesired signals at the RF input port. For example, any noise within the IF passband generated by a previous active system block (LNA or any other amplifier) is directly transferred and amplified to the IF output. This lack of isolation can considerably degrade the translated signal to noise ratio of the IF output. An image filter placed before the mixer RF input port can solve the problem. Image filters are normally implemented as narrow bandpass filters which are tuned to pass only the desired (LO+IF) or (LO-IF) frequency of interest. Consequently, the role of rejecting noise at frequencies within the IF passband is accomplished.

Poor isolation from the LO input to IF output can also slightly degrade the translated signal to noise ratio of the IF output in two distinct ways: the noise generated by the local oscillator at the IF frequency band is directly coupled to the IF port, and the noise at the RF and image RF passbands (LO SSB noise) gets translated to the IF passband and appears in the IF output. To overcome these problems, the use of a band pass filter is recommended between the local oscillator and the LO input for optimization of the mixer noise figure.

The lack of isolation from the LO input port back to the RF input port can cause constructive or destructive interference at the RF port which can affect noise and conversion (translation) gain performance.

Cascaded Evaluation

The cascaded evaluation of the HFA3600 demo-board must be carried out with a filter network between the LNA and the mixer when noise figure or sensitivity measurements are made. Any bandpass/highpass implementation must be utilized to function as either an image or noise rejection filter.

To remove the IF noise being generated or amplified by the LNA, a low cost Π or “T” high pass filter can be utilized. This simple high pass filter can be used for a cascaded noise evaluation of the HFA3600. Although this implementation does not remove the image signal nor the image noise being generated by the LNA, this filter gives an overall cascaded performance that closely approximates the results obtained by calculation. The large contribution of the LNA gain at the IF frequency (from a white noise source at its input and its own IF noise), to the overall noise figure measurement is practically eliminated by the high pass filter. Figure 1 shows an implementation of a high pass filter network used to filter out the incoming IF noise from the LNA. A rider board can be built to connect the **LNAOUT** and the **RFIN** SMA connectors of the demo-board. The 1000pF decoupling capacitors are included in the demo-board.

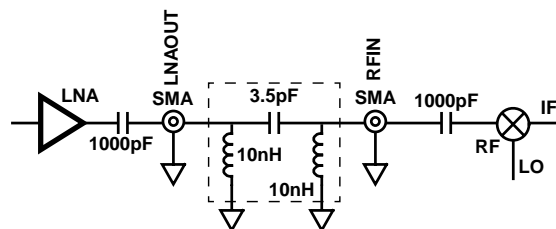

Π COMPONENTS SHOWN ARE FOR 900MHz RF
A “T” FILTER CAN ELIMINATE THE 1000pF COUPLING CAPACITORS

FIGURE 36. HFA3600 HIGH PASS FILTER IMPLEMENTATION

Tuning of the Π network, if necessary, is done by changing the value of the 3.5pF capacitor. This low value of capacitance may be dependent on the rider layout. The value may be optimized for low insertion loss and, therefore, for optimum cascaded noise figure.

Figure 37 and Tables 2 and 3 illustrate the overall performance of the HFA3600 in a cascaded form at 915MHz RF input and 75MHz IF frequency:

TABLE 2. SSB MEASUREMENT SET UP (BANDPASS INPUT FILTER) (NOTES 1, 3)

IMAGE FILTER	NF (dB)	GAIN (dB)	COMMENTS
Saw, 3dB Loss	5.1	16.0	Gain reduced by the filter loss
Short/No Filter	14.4	N/A	NF degrades due to the IF noise from the LNA
Π Filter, No Loss at the RF Frequency	5.2	19.0	Note the increase in cascaded gain

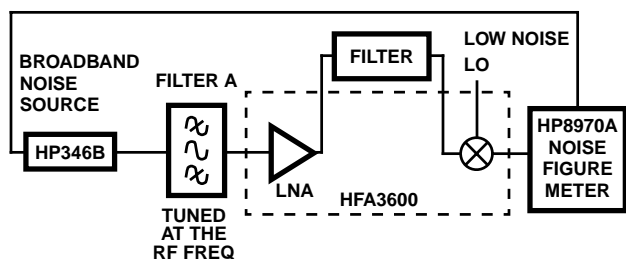

FIGURE 37A. SSB NOISE FIGURE MEASUREMENT

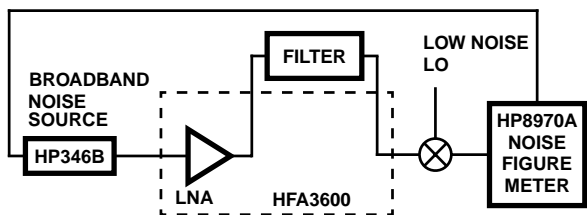

FIGURE 37B. DSB NOISE FIGURE MEASUREMENT

TABLE 3. DSB MEASUREMENT SET UP (NO INPUT BANDPASS FILTER)

IMAGE FILTER	NF (dB)	GAIN (dB)	COMMENTS
Saw, 3dB Loss	5.1	16.0	Equivalent to SSB Measurement
Short/No Filter	1.8	31	Invalid Measurement
Π Filter, No Loss at the RF Frequency	3.6	19.0	Note 3

NOTES:

- The single side band input filter (filter A) loss is accounted for and removed in the Noise figure and gain values.
- The difference of a DSB to a SSB noise figure is theoretically 3dB. The expected value of 2.2dB NF for a DSB measurement is degraded to 3.6dB due to a small attenuation of the Π filter at the image frequency.
- The cascaded results presented in the AC Specifications Table of the data sheet are calculated assuming the use of an ideal image filter (no loss) and a SSB measurement.

HFA3600 Mixer Evaluation Notes

The evaluation of the HFA3600 mixer by itself is facilitated by the demo-board design which provides access to the 3 ports by SMA connectors. As discussed before, RF to IF feedthrough and LO to RF/IF ports moderate isolation can cause errors during noise measurements.

The inherent RF to IF feedthrough of the single balanced mixer mandates that noise measurements be single side band only (with an appropriate band pass filter at the RF frequency of interest). Because of this lack of isolation, the incoming energy located at the IF passband from a

broadband noise source for example, will feedthrough and cause significant noise figure measurement errors.

As noise measurement equipment often makes use of broadband noise sources with energy covering a wide spectrum, SSB measurements are made using a band pass filter in front of the RF port. The role of the band pass filter is to prevent the image and IF noise energy from being fed to the mixer.

However, band pass filters exhibit poor return losses at frequencies outside their passbands. Because a moderate amount of power from a local oscillator is transferred back to the RF port in many active mixers, and this returned LO signal is outside the passband of the SSB filter being used, the signal will get reflected back again to the RF port due to impedance mismatch between the filter and the RF port. This impedance mismatch occurs at the LO frequency and these multiple signal reflections can affect gain and noise performance of the mixer. This situation, although not a problem for the actual receiver design, can become a source of error during mixer noise measurements.

To minimize the problem, the simplest method is to provide a short connection (well below $\lambda/4$ of the LO frequency) between the filter and the RF port. In case a coaxial cable connection is required, it may be necessary to provide a length of cable which assures minimum degradation to the noise figure reading. Long cables above 3 feet can provide the required standing wave dissipation for measurements in the 800MHz to 1GHz range. Note that long cable losses must be taken into account for the purpose of noise figure measurements. Adjustable line stretchers or isolators at the RF input port could also be used to optimize noise figure readings as an option for the mixer evaluation.

And finally, the recommendation of filtering the local oscillator signal before applying it to the LO port is important for accuracy of noise measurements when evaluating the mixer by itself, due to the typical LO to IF feedthrough in single balanced mixers.

HFA3600 LNA Evaluation Notes

The evaluation of the LNA is straightforward. SMA connectors are provided in the demo-board. There are no recommendations for evaluating the LNA block other than using typical RF amplifier test techniques.

Final Note

The cascaded evaluation of the HFA3600 LNA and mixer blocks including an image rejection or high pass filter is the best method to obtain accurate results. The gain and noise performance contribution of the LNA and filter to the cascaded results surpass considerably the performance contribution of the mixer. The data collected by cascading the blocks together reflects the performance at the system level which includes the filter of choice for a required design.

Small Outline Plastic Packages (SOIC)

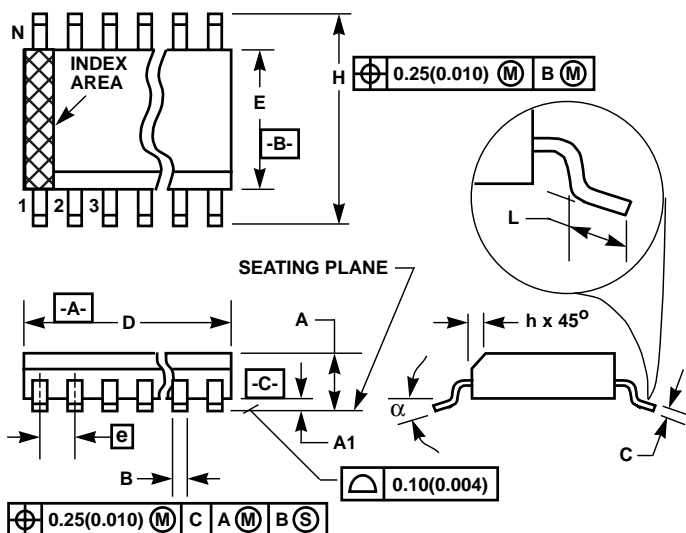

**M14.15 (JEDEC MS-012-AB ISSUE C)
14 LEAD NARROW BODY SMALL OUTLINE PLASTIC PACKAGE**

SYMBOL	INCHES		MILLIMETERS		NOTES
	MIN	MAX	MIN	MAX	
A	0.0532	0.0688	1.35	1.75	-
A1	0.0040	0.0098	0.10	0.25	-
B	0.013	0.020	0.33	0.51	9
C	0.0075	0.0098	0.19	0.25	-
D	0.3367	0.3444	8.55	8.75	3
E	0.1497	0.1574	3.80	4.00	4
e	0.050 BSC		1.27 BSC		-
H	0.2284	0.2440	5.80	6.20	-
h	0.0099	0.0196	0.25	0.50	5
L	0.016	0.050	0.40	1.27	6
N	14		14		7
α	0°	8°	0°	8°	-

NOTES:

1. Symbols are defined in the "MO Series Symbol List" in Section 2.2 of Publication Number 95.
2. Dimensioning and tolerancing per ANSI Y14.5M-1982.
3. Dimension "D" does not include mold flash, protrusions or gate burrs. Mold flash, protrusion and gate burrs shall not exceed 0.15mm (0.006 inch) per side.
4. Dimension "E" does not include interlead flash or protrusions. Interlead flash and protrusions shall not exceed 0.25mm (0.010 inch) per side.
5. The chamfer on the body is optional. If it is not present, a visual index feature must be located within the crosshatched area.
6. "L" is the length of terminal for soldering to a substrate.
7. "N" is the number of terminal positions.
8. Terminal numbers are shown for reference only.
9. The lead width "B", as measured 0.36mm (0.014 inch) or greater above the seating plane, shall not exceed a maximum value of 0.61mm (0.024 inch).
10. Controlling dimension: MILLIMETER. Converted inch dimensions are not necessarily exact.

Rev. 0 12/93

All Intersil semiconductor products are manufactured, assembled and tested under **ISO9000** quality systems certification.

Intersil semiconductor products are sold by description only. Intersil Corporation reserves the right to make changes in circuit design and/or specifications at any time without notice. Accordingly, the reader is cautioned to verify that data sheets are current before placing orders. Information furnished by Intersil is believed to be accurate and reliable. However, no responsibility is assumed by Intersil or its subsidiaries for its use; nor for any infringements of patents or other rights of third parties which may result from its use. No license is granted by implication or otherwise under any patent or patent rights of Intersil or its subsidiaries.

For information regarding Intersil Corporation and its products, see web site www.intersil.com

Sales Office Headquarters

NORTH AMERICA

Intersil Corporation
P. O. Box 883, Mail Stop 53-204
Melbourne, FL 32902
TEL: (407) 724-7000
FAX: (407) 724-7240

EUROPE

Intersil SA
Mercure Center
100, Rue de la Fusee
1130 Brussels, Belgium
TEL: (32) 2.724.2111
FAX: (32) 2.724.22.05

ASIA

Intersil (Taiwan) Ltd.
7F-6, No. 101 Fu Hsing North Road
Taipei, Taiwan
Republic of China
TEL: (886) 2 2716 9310
FAX: (886) 2 2715 3029