

30A, 400V - 600V Hyperfast Diodes

The RHRG3040 and RHRG3060 are hyperfast diodes with soft recovery characteristics ($t_{rr} < 40ns$). They have half the recovery time of ultrafast diodes and are of silicon nitride passivated ion-implanted epitaxial planar construction.

These devices are intended for use as freewheeling/clamping diodes and rectifiers in a variety of switching power supplies and other power switching applications. Their low stored charge and hyperfast soft recovery minimize ringing and electrical noise in many power switching circuits, thus reducing power loss in the switching transistors.

Formerly developmental type TA49063.

Ordering Information

PART NUMBER	PACKAGE	BRAND
RHRG3040	TO-247	RHRG3040
RHRG3060	TO-247	RHRG3060

NOTE: When ordering, use the entire part number.

Symbol



Features

- Hyperfast with Soft Recovery <40ns
- Operating Temperature 175°C
- Reverse Voltage Up To 600V
- Avalanche Energy Rated
- Planar Construction

Applications

- Switching Power Supplies
- Power Switching Circuits
- General Purpose

Packaging

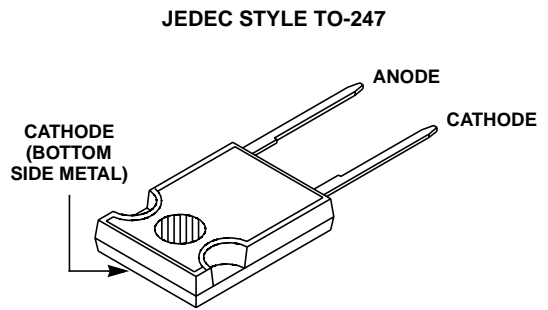

Absolute Maximum Ratings $T_C = 25^{\circ}C$, Unless Otherwise Specified

	RHRG3040	RHRG3060	UNITS
Peak Repetitive Reverse Voltage V_{RRM}	400	600	V
Working Peak Reverse Voltage V_{RWM}	400	600	V
DC Blocking Voltage V_R	400	600	V
Average Rectified Forward Current $I_{F(AV)}$ ($T_C = 120^{\circ}C$)	30	30	A
Repetitive Peak Surge Current I_{FRM} (Square Wave, 20kHz)	70	70	A
Nonrepetitive Peak Surge Current I_{FSM} (Halfwave, 1 Phase, 60Hz)	325	325	A
Maximum Power Dissipation P_D	125	125	W
Avalanche Energy (See Figures 10 and 11) E_{AVL}	20	20	mJ
Operating and Storage Temperature T_{STG}, T_J	-65 to 175	-65 to 175	°C

Electrical Specifications $T_C = 25^\circ\text{C}$, Unless Otherwise Specified

SYMBOL	TEST CONDITION	RHRG3040			RHRG3060			UNITS
		MIN	TYP	MAX	MIN	TYP	MAX	
V_F	$I_F = 30\text{A}$	-	-	2.1	-	-	2.1	V
	$I_F = 30\text{A}, T_C = 150^\circ\text{C}$	-	-	1.7	-	-	1.7	V
I_R	$V_R = 400\text{V}$	-	-	250	-	-	-	μA
	$V_R = 600\text{V}$	-	-	-	-	-	250	μA
	$V_R = 400\text{V}, T_C = 150^\circ\text{C}$	-	-	1.0	-	-	-	mA
	$V_R = 600\text{V}, T_C = 150^\circ\text{C}$	-	-	-	-	-	1.0	mA
t_{rr}	$I_F = 1\text{A}, di_F/dt = 200\text{A}/\mu\text{s}$	-	-	40	-	-	40	ns
	$I_F = 30\text{A}, di_F/dt = 200\text{A}/\mu\text{s}$	-	-	45	-	-	45	ns
t_a	$I_F = 30\text{A}, di_F/dt = 200\text{A}/\mu\text{s}$	-	22	-	-	22	-	ns
t_b	$I_F = 30\text{A}, di_F/dt = 200\text{A}/\mu\text{s}$	-	18	-	-	18	-	ns
Q_{RR}	$I_F = 30\text{A}, di_F/dt = 200\text{A}/\mu\text{s}$	-	100	-	-	100	-	nC
C_J	$V_R = 10\text{V}, I_F = 0\text{A}$	-	85	-	-	85	-	pF
$R_{\theta JC}$		-	-	1.2	-	-	1.2	$^\circ\text{C}/\text{W}$

DEFINITIONS

V_F = Instantaneous forward voltage ($p_w = 300\mu\text{s}$, $D = 2\%$).

I_R = Instantaneous reverse current.

t_{rr} = Reverse recovery time (See Figure 9), summation of $t_a + t_b$.

t_a = Time to reach peak reverse current (See Figure 9).

t_b = Time from peak I_{RM} to projected zero crossing of I_{RM} based on a straight line from peak I_{RM} through 25% of I_{RM} (See Figure 9).

Q_{RR} = Reverse recovery charge.

C_J = Junction Capacitance.

$R_{\theta JC}$ = Thermal resistance junction to case.

p_w = Pulse width.

D = Duty cycle.

Typical Performance Curves

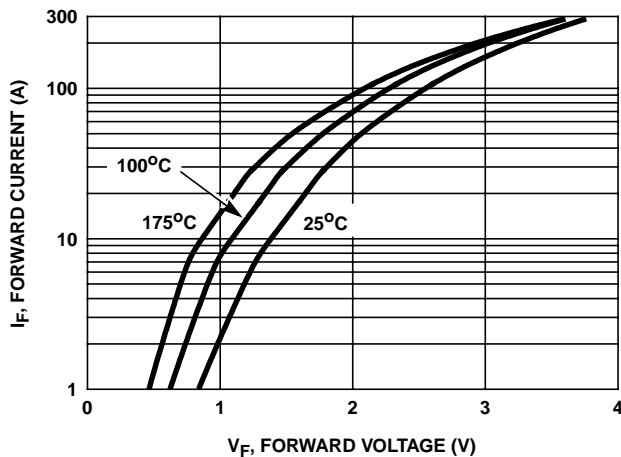

FIGURE 1. FORWARD CURRENT vs FORWARD VOLTAGE

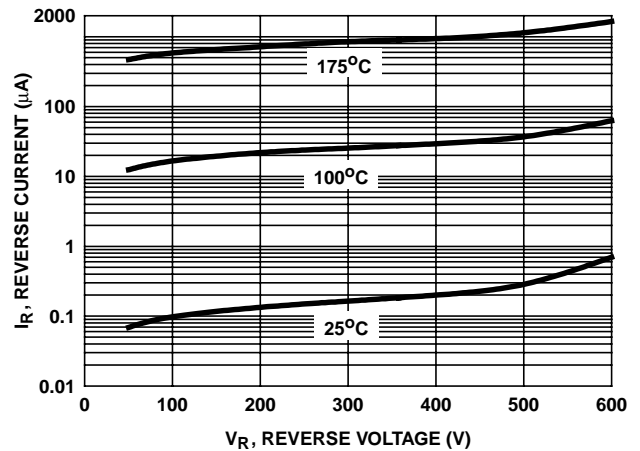

FIGURE 2. REVERSE CURRENT vs REVERSE VOLTAGE

Typical Performance Curves (Continued)

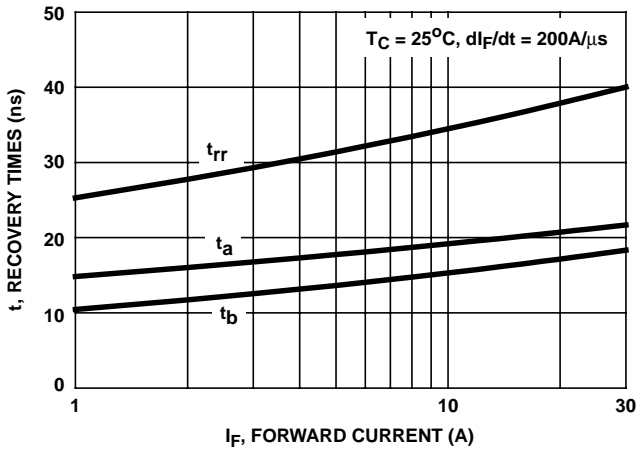

FIGURE 3. t_{rr} , t_a AND t_b CURVES vs FORWARD CURRENT

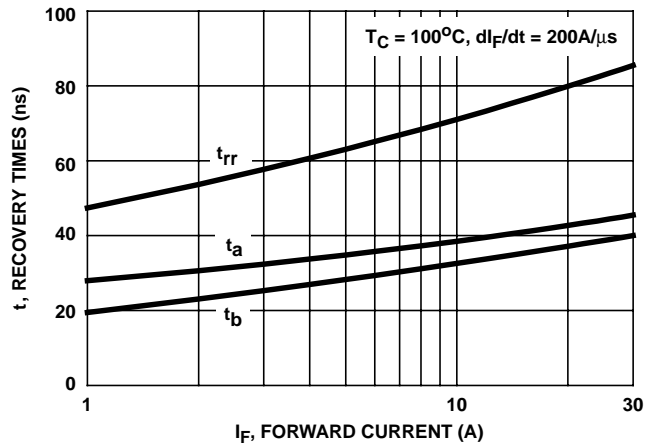

FIGURE 4. t_{rr} , t_a AND t_b CURVES vs FORWARD CURRENT

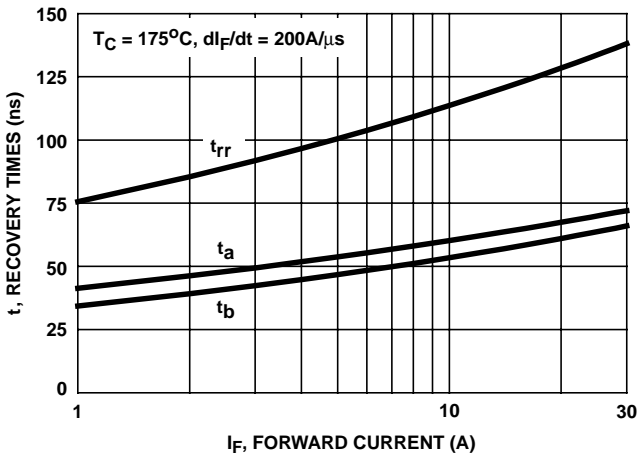

FIGURE 5. t_{rr} , t_a AND t_b CURVES vs FORWARD CURRENT

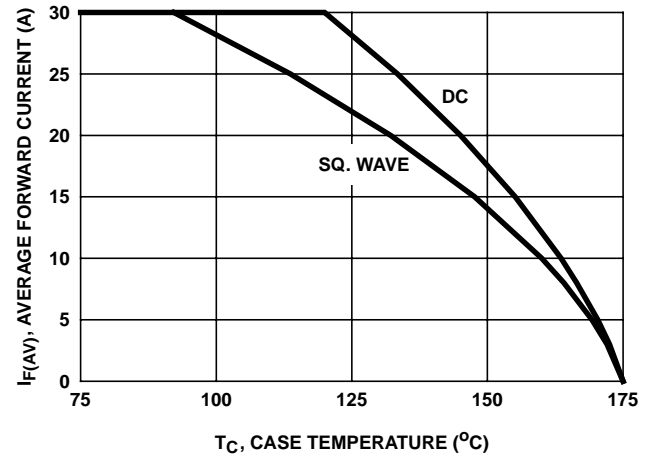

FIGURE 6. CURRENT DERATING CURVE

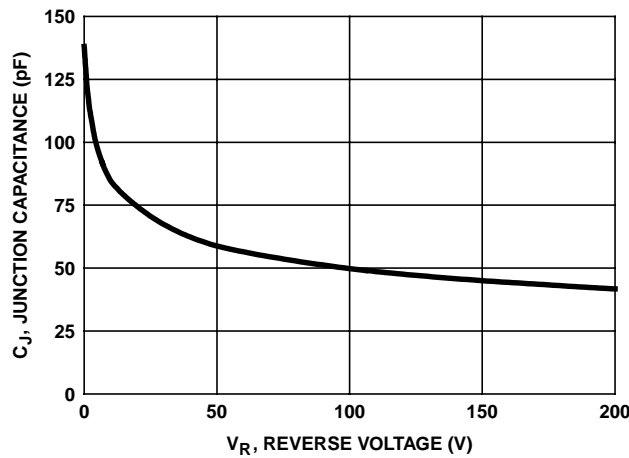

FIGURE 7. JUNCTION CAPACITANCE vs REVERSE VOLTAGE

Test Circuits and Waveforms

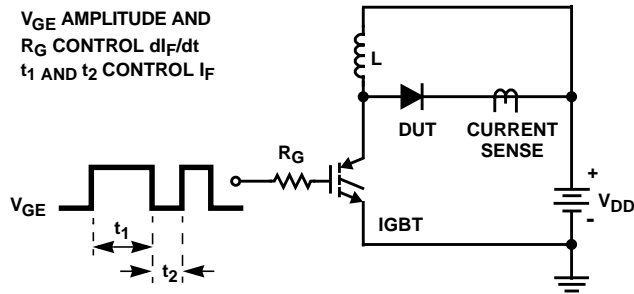

FIGURE 8. t_{rr} TEST CIRCUIT

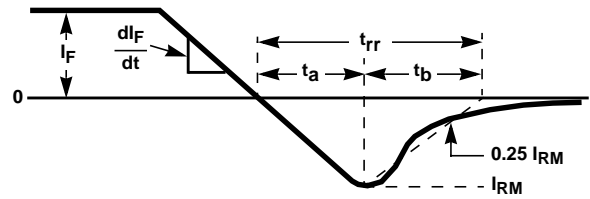

FIGURE 9. t_{rr} WAVEFORMS AND DEFINITIONS

$I_{MAX} = 1A$
 $L = 40mH$
 $R < 0.1\Omega$
 $E_{AVL} = 1/2LI^2 [V_{R(AVL)}/(V_{R(AVL)} - V_{DD})]$
 $Q_1 = IGBT (BV_{CES} > DUT V_{R(AVL)})$



FIGURE 10. AVALANCHE ENERGY TEST CIRCUIT

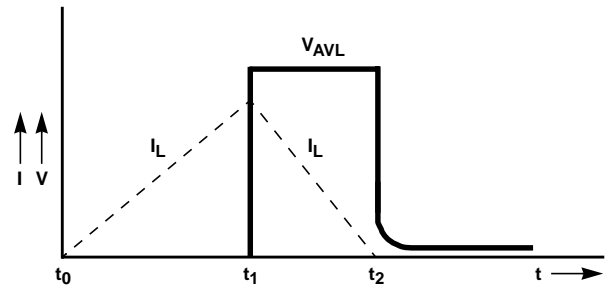

FIGURE 11. AVALANCHE CURRENT AND VOLTAGE WAVEFORMS

All Intersil semiconductor products are manufactured, assembled and tested under **ISO9000** quality systems certification.

Intersil semiconductor products are sold by description only. Intersil Corporation reserves the right to make changes in circuit design and/or specifications at any time without notice. Accordingly, the reader is cautioned to verify that data sheets are current before placing orders. Information furnished by Intersil is believed to be accurate and reliable. However, no responsibility is assumed by Intersil or its subsidiaries for its use; nor for any infringements of patents or other rights of third parties which may result from its use. No license is granted by implication or otherwise under any patent or patent rights of Intersil or its subsidiaries.

For information regarding Intersil Corporation and its products, see web site www.intersil.com