

6A, 400V - 600V Hyperfast Dual Diodes

RHRP640CC, RHRP650CC and RHRP660CC are hyperfast dual diodes with soft recovery characteristics ($t_{rr} < 30ns$). They have half the recovery time of ultrafast diodes and are silicon nitride passivated ion-implanted hepaticas planar construction.

These devices are intended for use as freewheeling/clamping diodes and rectifiers in a variety of switching power supplies and other power switching applications. Their low stored charge and ultrafast soft recovery minimize ringing and electrical noise in many power switching circuits reducing power loss in the switching transistors.

Formerly developmental type TA49057.

Ordering Information

PART NUMBER	PACKAGE	BRAND
RHRP640CC	TO-220AB	RHRP640C
RHRP650CC	TO-220AB	RHRP650C
RHRP660CC	TO-220AB	RHRP660C

NOTE: When ordering, use the entire part number.

Features

- Hyperfast with Soft Recovery<30ns
- Operating Temperature 175°C
- Reverse Voltage Up To600V
- Avalanche Energy Rated
- Planar Construction
- Related Literature
 - TB334 "Guidelines for Soldering Surface Mount Components to PC Boards"

Applications

- Switching Power Supplies
- Power Switching Circuits
- General Purpose

Symbol

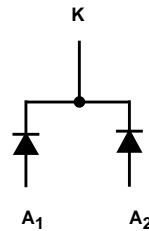

Package

JEDEC TO-220AB

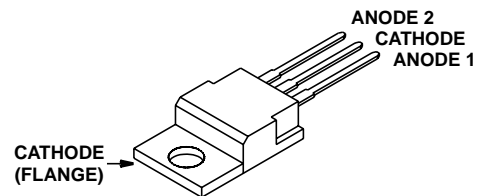

RHRP640CC, RHRP650CC, RHRP660CC

Absolute Maximum Ratings (Per Leg) $T_C = 25^\circ\text{C}$, Unless Otherwise Specified

	RHRP640CC	RHRP650CC	RHRP660CC	UNITS	
Peak Repetitive Reverse Voltage	V_{RRM}	400	500	600	V
Working Peak Reverse Voltage	V_{RWM}	400	500	600	V
DC Blocking Voltage	V_R	400	500	600	V
Average Rectified Forward Current	$I_{F(AV)}$	6	6	6	A
$T_C = 152^\circ\text{C}$					
Repetitive Peak Surge Current	I_{FSM}	12	12	12	A
Square Wave, 20kHz					
Nonrepetitive Peak Surge Current	I_{FSM}	60	60	60	A
Halfwave, 1 phase, 60Hz					
Maximum Power Dissipation	P_D	50	50	50	W
Avalanche Energy (See Figures 10 and 11)	E_{AVL}	10	10	10	mJ
Operating and Storage Temperature	T_{STG}, T_J	-65 to 175	-65 to 175	-65 to 175	$^\circ\text{C}$
Maximum Temperature for Soldering					
Leads at 0.063in (1.6mm) from Case for 10s	T_L	300	300	300	$^\circ\text{C}$
Package Body for 10s, see Tech Brief 334	T_{pk}	260	260	260	$^\circ\text{C}$

CAUTION: Stresses above those listed in "Absolute Maximum Ratings" may cause permanent damage to the device. This is a stress only rating and operation of the device at these or any other conditions above those indicated in the operational sections of this specification is not implied.

Electrical Specifications (Per Leg) $T_C = 25^\circ\text{C}$, Unless Otherwise Specified

SYMBOL	TEST CONDITION	RHRP640CC			RHRP650CC			RHRP660CC			UNITS
		MIN	TYP	MAX	MIN	TYP	MAX	MIN	TYP	MAX	
V_F	$I_F = 6\text{A}$	-	-	2.1	-	-	2.1	-	-	2.1	V
	$I_F = 6\text{A}, T_C = 150^\circ\text{C}$	-	-	1.7	-	-	1.7	-	-	1.7	V
I_R	$V_R = 400\text{V}$	-	-	100	-	-	-	-	-	-	μA
	$V_R = 500\text{V}$	-	-	-	-	-	100	-	-	-	μA
	$V_R = 600\text{V}$	-	-	-	-	-	-	-	-	100	μA
	$V_R = 400\text{V}, T_C = 150^\circ\text{C}$	-	-	500	-	-	-	-	-	-	μA
	$V_R = 500\text{V}, T_C = 150^\circ\text{C}$	-	-	-	-	-	500	-	-	-	μA
	$V_R = 600\text{V}, T_C = 150^\circ\text{C}$	-	-	-	-	-	-	-	-	500	μA
t_{rr}	$I_F = 1\text{A}, dI_F/dt = 200\text{A}/\mu\text{s}$	-	-	30	-	-	30	-	-	30	ns
	$I_F = 6\text{A}, dI_F/dt = 200\text{A}/\mu\text{s}$	-	-	35	-	-	35	-	-	35	ns
t_a	$I_F = 6\text{A}, dI_F/dt = 200\text{A}/\mu\text{s}$	-	16	-	-	16	-	-	16	-	ns
t_b	$I_F = 6\text{A}, dI_F/dt = 200\text{A}/\mu\text{s}$	-	8.5	-	-	8.5	-	-	8.5	-	ns
Q_{RR}	$I_F = 6\text{A}, dI_F/dt = 200\text{A}/\mu\text{s}$	-	45	-	-	45	-	-	45	-	nC
C_J	$V_R = 10\text{V}, I_F = 0\text{A}$	-	20	-	-	20	-	-	20	-	pF
$R_{\theta JC}$		-	-	3	-	-	3	-	-	3	$^\circ\text{C}/\text{W}$

DEFINITIONS

- V_F = Instantaneous forward voltage (pw = 300 μs , D = 2%).
- I_R = Instantaneous reverse current.
- t_{rr} = Reverse recovery time (See Figure 9), summation of $t_a + t_b$.
- t_a = Time to reach peak reverse current (See Figure 9).
- t_b = Time from peak I_{RM} to projected zero crossing of I_{RM} based on a straight line from peak I_{RM} through 25% of I_{RM} (See Figure 9).
- Q_{RR} = Reverse recovery charge.
- C_J = Junction Capacitance.
- $R_{\theta JC}$ = Thermal resistance junction to case.
- pw = pulse width.
- D = duty cycle.

Typical Performance Curves

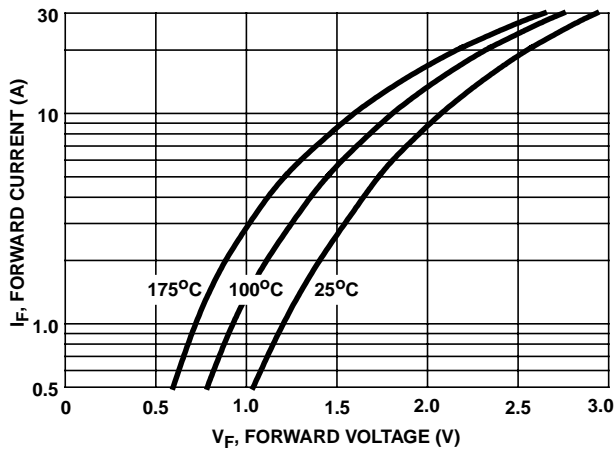

FIGURE 1. FORWARD CURRENT vs FORWARD VOLTAGE

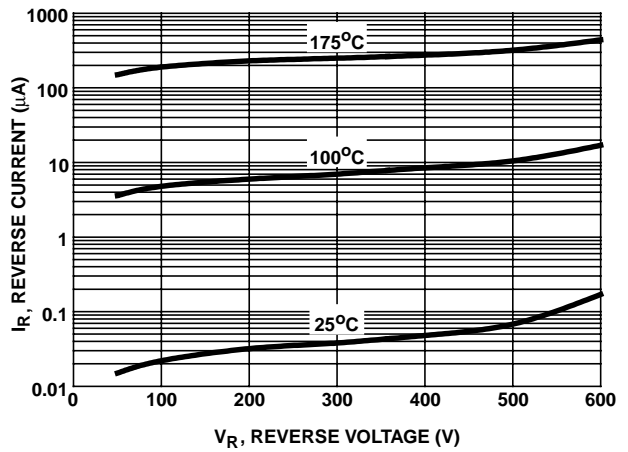

FIGURE 2. REVERSE CURRENT vs REVERSE VOLTAGE

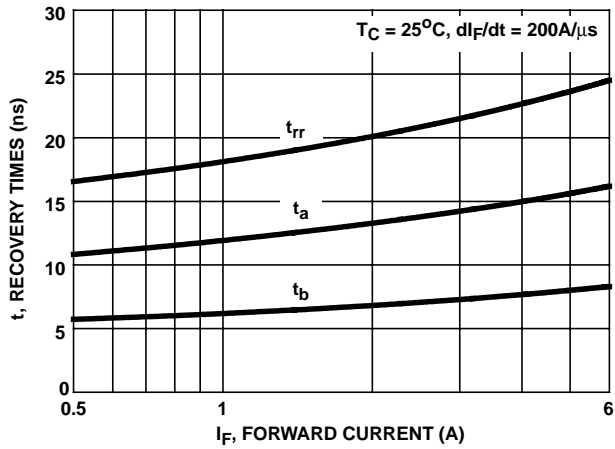

FIGURE 3. t_{rr} , t_a AND t_b CURVES vs FORWARD CURRENT

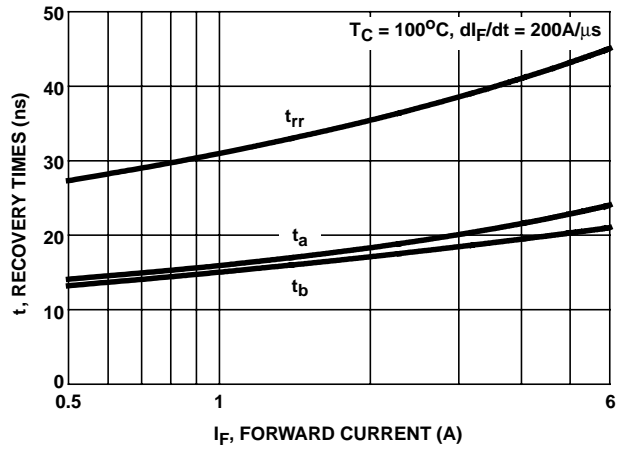

FIGURE 4. t_{rr} , t_a AND t_b CURVES vs FORWARD CURRENT

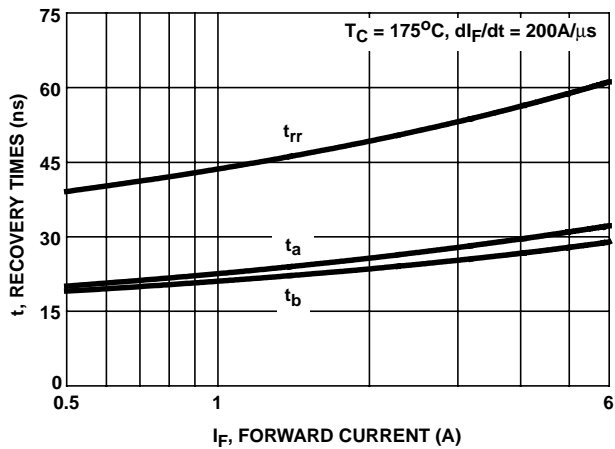

FIGURE 5. t_{rr} , t_a AND t_b CURVES vs FORWARD CURRENT

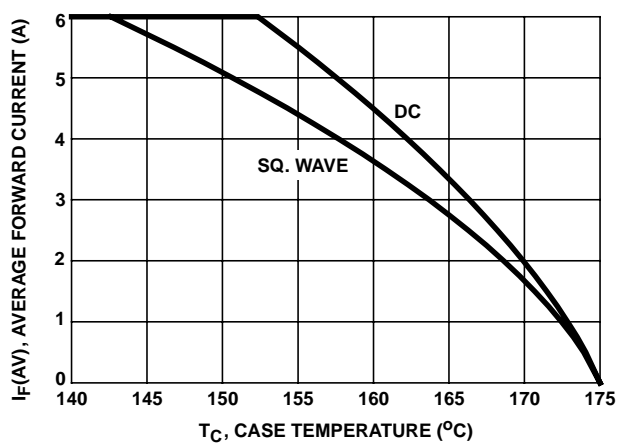

FIGURE 6. CURRENT DERATING CURVE

Typical Performance Curves (Continued)

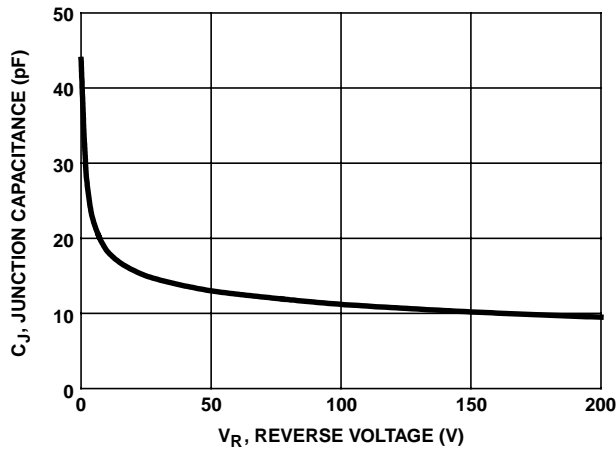

FIGURE 7. JUNCTION CAPACITANCE vs REVERSE VOLTAGE

Test Circuits and Waveforms

V_{GE} AMPLITUDE and
 R_G CONTROL di_F/dt
 t_1 AND t_2 CONTROL I_F

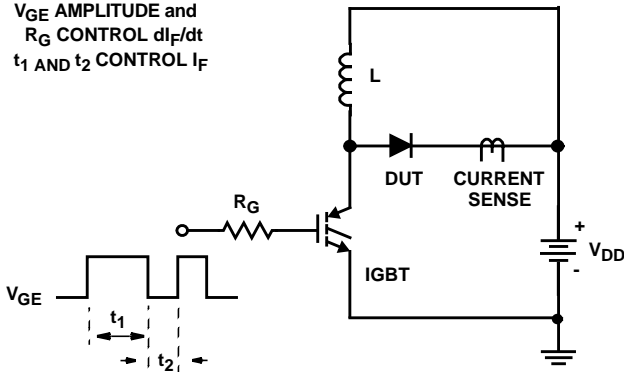

FIGURE 8. t_{rr} TEST CIRCUIT

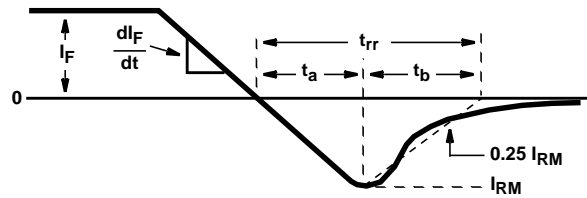

FIGURE 9. t_{rr} WAVEFORMS AND DEFINITIONS

$L = 20\text{mH}$
 $R < 0.1\Omega$
 $E_{AVL} = 1/2LI^2 [V_{R(AVL)}/(V_{R(AVL)} - V_{DD})]$
 $Q_1 = \text{IGBT } (BV_{CES} > \text{DUT } V_{R(AVL)})$

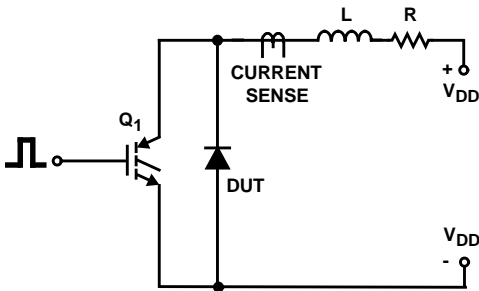

FIGURE 10. AVALANCHE ENERGY TEST CIRCUIT

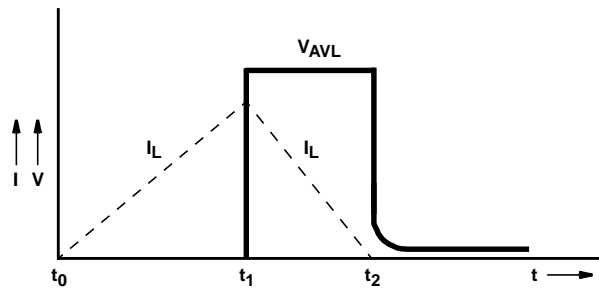

FIGURE 11. AVALANCHE CURRENT AND VOLTAGE WAVEFORMS

