

July 1998

### Features

- 47A, -100V,  $r_{DS(ON)} = 0.053\Omega$
- Total Dose
  - Meets Pre-RAD Specifications to 100K RAD (Si)
- Single Event
  - Safe Operating Area Curve for Single Event Effects
  - SEE Immunity for LET of 36MeV/mg/cm<sup>2</sup> with  $V_{DS}$  up to 80% of Rated Breakdown and  $V_{GS}$  of 10V Off-Bias
- Dose Rate
  - Typically Survives 3E9 RAD (Si)/s at 80%  $BV_{DSS}$
  - Typically Survives 2E12 if Current Limited to  $I_{DM}$
- Photo Current
  - 10.0nA Per-RAD(Si)/s Typically
- Neutron
  - Maintain Pre-RAD Specifications for 3E13 Neutrons/cm<sup>2</sup>
  - Usable to 3E14 Neutrons/cm<sup>2</sup>

### Ordering Information

RAD LEVEL	SCREENING LEVEL	PART NUMBER/BRAND
10K	Commercial	FSYC9160D1
10K	TXV	FSYC9160D3
100K	Commercial	FSYC9160R1
100K	TXV	FSYC9160R3
100K	Space	FSYC9160R4

Formerly available as type TA17766.

### Description

The Discrete Products Operation of Intersil has developed a series of Radiation Hardened MOSFETs specifically designed for commercial and military space applications. Enhanced Power MOSFET immunity to Single Event Effects (SEE), Single Event Gate Rupture (SEGR) in particular, is combined with 100K RADS of total dose hardness to provide devices which are ideally suited to harsh space environments. The dose rate and neutron tolerance necessary for military applications have not been sacrificed.

The Intersil portfolio of SEGR resistant radiation hardened MOSFETs includes N-Channel and P-Channel devices in a variety of voltage, current and on-resistance ratings. Numerous packaging options are also available.

This MOSFET is an enhancement-mode silicon-gate power field-effect transistor of the Vertical DMOS (VDMOS) structure. It is specially designed and processed to be radiation tolerant. The MOSFET is well suited for applications exposed to radiation environments such as switching regulation, switching converters, motor drives, relay drivers and drivers for high-power bipolar switching transistors requiring high speed and low gate drive power. This type can be operated directly from integrated circuits.

Reliability screening is available as either commercial, TXV equivalent of MIL-S-19500, or Space equivalent of MIL-S-19500. Contact Intersil for any desired deviations from the data sheet.

### Symbol

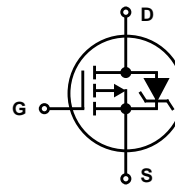

### Packaging

SMD-2

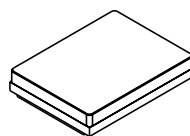

## FSYC9160D, FSYC9160R

### Absolute Maximum Ratings $T_C = 25^\circ\text{C}$ , Unless Otherwise Specified

	FSYC9160D, FSYC9160R	UNITS
Drain to Source Voltage	-100	V
Drain to Gate Voltage ( $R_{GS} = 20\text{k}\Omega$ )	-100	V
Continuous Drain Current		
$T_C = 25^\circ\text{C}$	47	A
$T_C = 100^\circ\text{C}$	30	A
Pulsed Drain Current	141	A
Gate to Source Voltage	$\pm 20$	V
Maximum Power Dissipation		
$T_C = 25^\circ\text{C}$	208	W
$T_C = 100^\circ\text{C}$	83	W
Linear Derating Factor	1.67	W/ $^\circ\text{C}$
Single Pulsed Avalanche Current, $L = 100\mu\text{H}$ , (See Test Figure)	141	A
Continuous Source Current (Body Diode)	47	A
Pulsed Source Current (Body Diode)	141	A
Operating and Storage Temperature	-55 to 150	$^\circ\text{C}$
Lead Temperature (During Soldering)	300	$^\circ\text{C}$

(Distance  $>0.063\text{in}$  (1.6mm) from Case, 10s Max)

*CAUTION: Stresses above those listed in "Absolute Maximum Ratings" may cause permanent damage to the device. This is a stress only rating and operation of the device at these or any other conditions above those indicated in the operational sections of this specification is not implied.*

### Electrical Specifications $T_C = 25^\circ\text{C}$ , Unless Otherwise Specified

PARAMETER	SYMBOL	TEST CONDITIONS	MIN	TYP	MAX	UNITS	
Drain to Source Breakdown Voltage	$BV_{DSS}$	$I_D = 1\text{mA}$ , $V_{GS} = 0\text{V}$	-100	-	-	V	
Gate Threshold Voltage	$V_{GS(TH)}$	$V_{GS} = V_{DS}$ , $I_D = 1\text{mA}$	$T_C = -55^\circ\text{C}$	-	-	-7.0	V
			$T_C = 25^\circ\text{C}$	-2.0	-	-6.0	V
			$T_C = 125^\circ\text{C}$	-1.0	-	-	V
Zero Gate Voltage Drain Current	$I_{DSS}$	$V_{DS} = -80\text{V}$ , $V_{GS} = 0\text{V}$	$T_C = 25^\circ\text{C}$	-	-	25	$\mu\text{A}$
			$T_C = 125^\circ\text{C}$	-	-	250	$\mu\text{A}$
Gate to Source Leakage Current	$I_{GSS}$	$V_{GS} = \pm 20\text{V}$	$T_C = 25^\circ\text{C}$	-	-	100	nA
			$T_C = 125^\circ\text{C}$	-	-	200	nA
Drain to Source On-State Voltage	$V_{DS(ON)}$	$V_{GS} = -12\text{V}$ , $I_D = 47\text{A}$	-	-	-2.74	V	
Drain to Source On Resistance	$r_{DS(ON)12}$	$I_D = 30\text{A}$ , $V_{GS} = -12\text{V}$	$T_C = 25^\circ\text{C}$	-	0.034	0.053	$\Omega$
			$T_C = 125^\circ\text{C}$	-	-	0.083	$\Omega$
Turn-On Delay Time	$t_{d(ON)}$	$V_{DD} = -50\text{V}$ , $I_D = 47\text{A}$ , $R_L = 1.1\Omega$ , $V_{GS} = -12\text{V}$ , $R_{GS} = 2.35\Omega$	-	-	50	ns	
Rise Time	$t_r$		-	-	75	ns	
Turn-Off Delay Time	$t_{d(OFF)}$		-	-	100	ns	
Fall Time	$t_f$		-	-	50	ns	
Total Gate Charge	$Q_g(TOT)$	$V_{GS} = 0\text{V}$ to $-20\text{V}$	$V_{DD} = -50\text{V}$ , $I_D = 47\text{A}$	-	-	410	nC
Gate Charge at 12V	$Q_g(12)$	$V_{GS} = 0\text{V}$ to $-12\text{V}$		-	220	250	nC
Threshold Gate Charge	$Q_g(TH)$	$V_{GS} = 0\text{V}$ to $-2\text{V}$		-	-	17	nC
Gate Charge Source	$Q_{gs}$			-	48	66	nC
Gate Charge Drain	$Q_{gd}$			-	85	120	nC
Plateau Voltage	$V_{(PLATEAU)}$	$I_D = 47\text{A}$ , $V_{DS} = -15\text{V}$		-	-7	-	V
Input Capacitance	$C_{ISS}$	$V_{DS} = -25\text{V}$ , $V_{GS} = 0\text{V}$ , $f = 1\text{MHz}$	-	5600	-	pF	
Output Capacitance	$C_{OSS}$		-	1550	-	pF	
Reverse Transfer Capacitance	$C_{RSS}$		-	560	-	pF	
Thermal Resistance Junction to Case	$R_{\theta JC}$		-	-	0.6	$^\circ\text{C/W}$	

## FSYC9160D, FSYC9160R

### Source to Drain Diode Specifications

PARAMETER	SYMBOL	TEST CONDITIONS	MIN	TYP	MAX	UNITS
Forward Voltage	$V_{SD}$	$I_{SD} = 47A$	-0.6	-	-1.8	V
Reverse Recovery Time	$t_{rr}$	$I_{SD} = 47A, dI_{SD}/dt = 100A/\mu s$	-	-	200	ns

### Electrical Specifications up to 100K RAD $T_C = 25^\circ C$ , Unless Otherwise Specified

PARAMETER	SYMBOL	TEST CONDITIONS	MIN	MAX	UNITS
Drain to Source Breakdown Volts (Note 3)	$BV_{DSS}$	$V_{GS} = 0, I_D = 1mA$	-100	-	V
Gate to Source Threshold Volts (Note 3)	$V_{GS(TH)}$	$V_{GS} = V_{DS}, I_D = 1mA$	-2.0	-6.0	V
Gate to Body Leakage (Notes 2, 3)	$I_{GSS}$	$V_{GS} = \pm 20V, V_{DS} = 0V$	-	100	nA
Zero Gate Leakage (Note 3)	$I_{DSS}$	$V_{GS} = 0, V_{DS} = -80V$	-	25	$\mu A$
Drain to Source On-State Volts (Notes 1, 3)	$V_{DS(ON)}$	$V_{GS} = -12V, I_D = 47A$	-	-2.74	V
Drain to Source On Resistance (Notes 1, 3)	$r_{DS(ON)12}$	$V_{GS} = -12V, I_D = 30A$	-	0.053	$\Omega$

**NOTES:**

1. Pulse test, 300 $\mu s$  Max.
2. Absolute value.
3. Insitu Gamma bias must be sampled for both  $V_{GS} = -12V, V_{DS} = 0V$  and  $V_{GS} = 0V, V_{DS} = 80\% BV_{DSS}$ .

### Single Event Effects (SEB, SEGR) Note 4

TEST	SYMBOL	ENVIRONMENT (NOTE 5)			APPLIED $V_{GS}$ BIAS (V)	(NOTE 6) MAXIMUM $V_{DS}$ BIAS (V)
		ION SPECIES	TYPICAL LET (MeV/mg/cm)	TYPICAL RANGE ( $\mu$ )		
Single Event Effects Safe Operating Area	SEESOA	Ni	26	43	20	-100
		Br	37	36	10	-100
		Br	37	36	15	-80
		Br	37	36	20	-50

**NOTES:**

4. Testing conducted at Brookhaven National Labs; sponsored by Naval Surface Warfare Center (NSWC), Crane, IN.
5. Fluence = 1E5 ions/cm<sup>2</sup> (typical), T = 25 $^\circ C$ .
6. Does not exhibit Single Event Burnout (SEB) or Single Event Gate Rupture (SEGR).

### Typical Performance Curves Unless Otherwise Specified

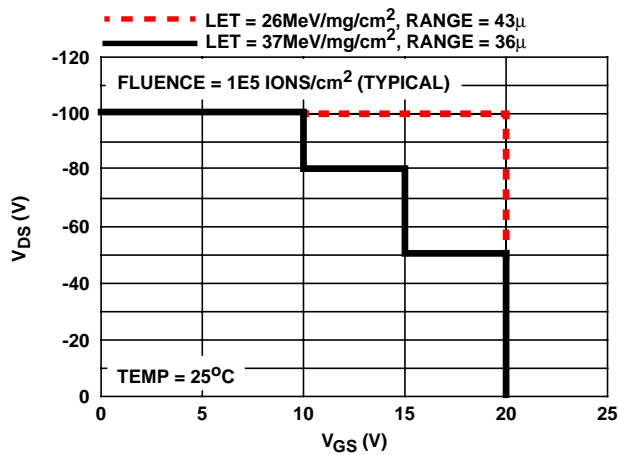

FIGURE 1. SINGLE EVENT EFFECTS SAFE OPERATING AREA

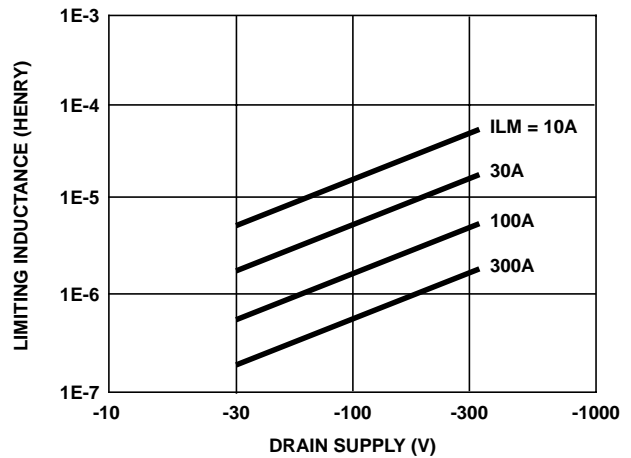

FIGURE 2. DRAIN INDUCTANCE REQUIRED TO LIMIT GAMMA DOT CURRENT TO  $I_{AS}$

Typical Performance Curves Unless Otherwise Specified (Continued)

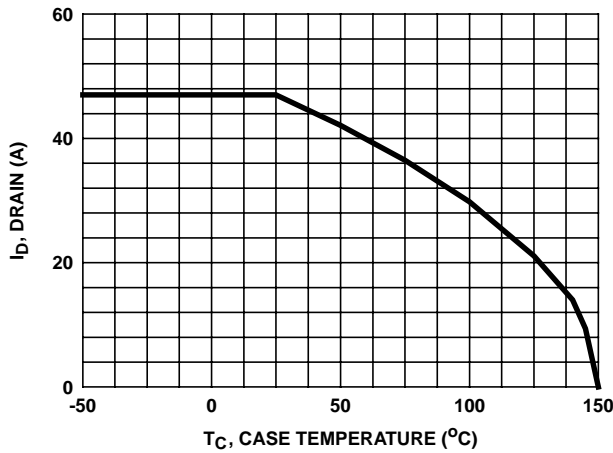

FIGURE 3. MAXIMUM CONTINUOUS DRAIN CURRENT vs TEMPERATURE

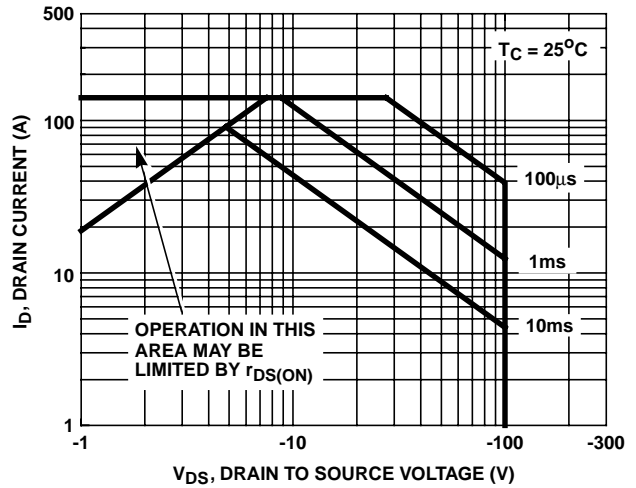

FIGURE 4. FORWARD BIAS SAFE OPERATING AREA

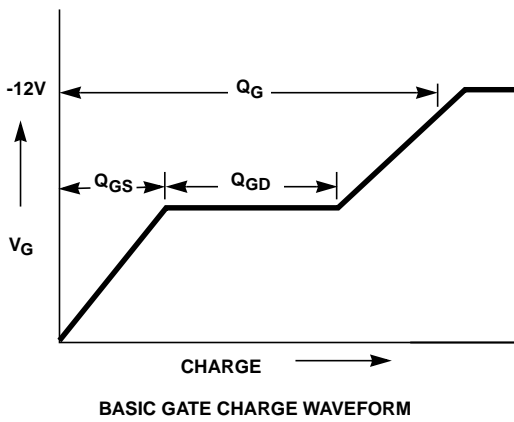

FIGURE 5. BASIC GATE CHARGE WAVEFORM

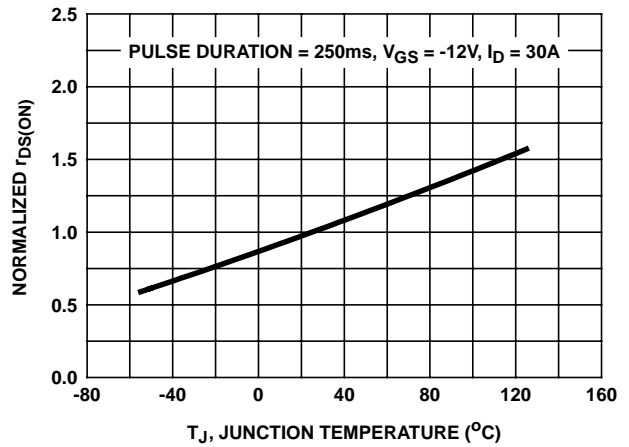

FIGURE 6. NORMALIZED  $r_{DS(ON)}$  vs JUNCTION TEMPERATURE

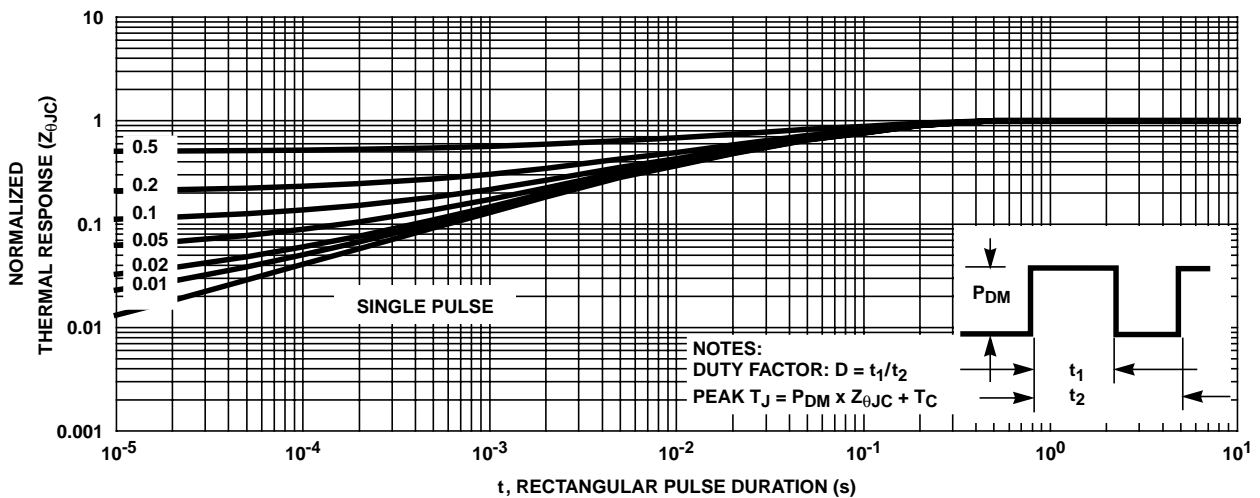

FIGURE 7. NORMALIZED MAXIMUM TRANSIENT THERMAL RESPONSE

Typical Performance Curves Unless Otherwise Specified (Continued)

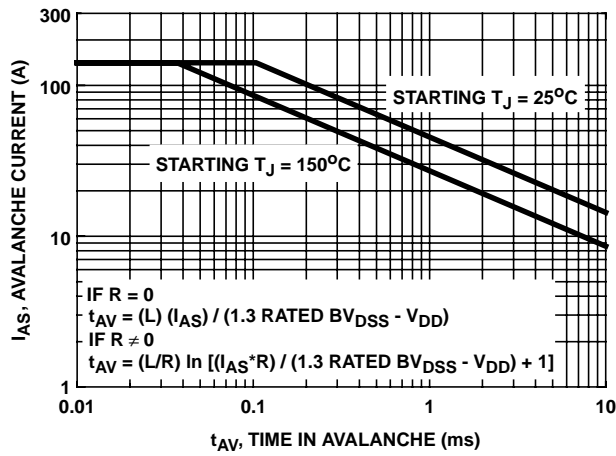

FIGURE 8. UNCLAMPED INDUCTIVE SWITCHING

Test Circuits and Waveforms

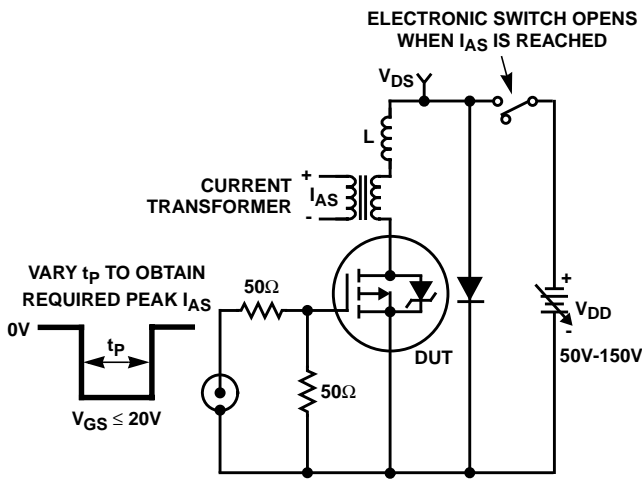

FIGURE 9. UNCLAMPED ENERGY TEST CIRCUIT

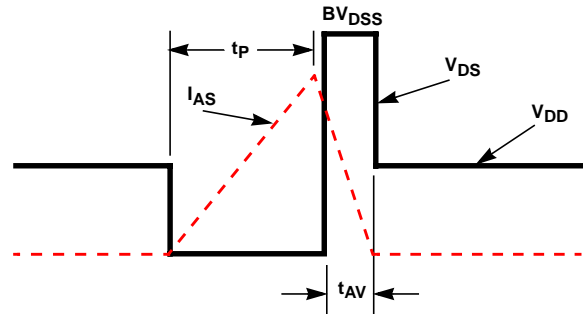

FIGURE 10. UNCLAMPED ENERGY WAVEFORMS

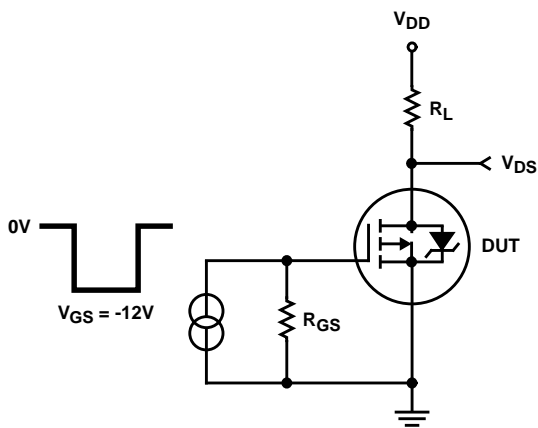

FIGURE 11. RESISTIVE SWITCHING TEST CIRCUIT

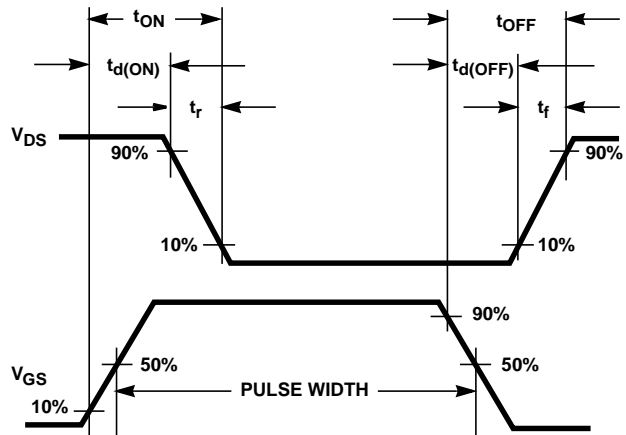

FIGURE 12. RESISTIVE SWITCHING WAVEFORMS

## FSYC9160D, FSYC9160R

### Screening Information

Screening is performed in accordance with the latest revision in effect of MIL-S-19500, (Screening Information Table).

**Delta Tests and Limits (JANTXV Equivalent, JANS Equivalent)  $T_C = 25^\circ\text{C}$ , Unless Otherwise Specified**

PARAMETER	SYMBOL	TEST CONDITIONS	MAX	UNITS
Gate to Source Leakage Current	$I_{GSS}$	$V_{GS} = \pm 20\text{V}$	$\pm 20$ (Note 7)	nA
Zero Gate Voltage Drain Current	$I_{DSS}$	$V_{DS} = 80\%$ Rated Value	$\pm 25$ (Note 7)	$\mu\text{A}$
Drain to Source On Resistance	$r_{DS(ON)}$	$T_C = 25^\circ\text{C}$ at Rated $I_D$	$\pm 20\%$ (Note 8)	$\Omega$
Gate Threshold Voltage	$V_{GS(TH)}$	$I_D = 1.0\text{mA}$	$\pm 20\%$ (Note 8)	V

NOTES:

7. Or 100% of Initial Reading (whichever is greater).
8. Of Initial Reading.

### Screening Information

TEST	JANTXV EQUIVALENT	JANS EQUIVALENT
Gate Stress	$V_{GS} = -30\text{V}$ , $t = 250\mu\text{s}$	$V_{GS} = -30\text{V}$ , $t = 250\mu\text{s}$
Pind	Optional	Required
Pre Burn-In Tests (Note 9)	MIL-S-19500 Group A, Subgroup 2 (All Static Tests at $25^\circ\text{C}$ )	MIL-S-19500 Group A, Subgroup 2 (All Static Tests at $25^\circ\text{C}$ )
Steady State Gate Bias (Gate Stress)	MIL-STD-750, Method 1042, Condition B $V_{GS} = 80\%$ of Rated Value, $T_A = 150^\circ\text{C}$ , Time = 48 hours	MIL-STD-750, Method 1042, Condition B $V_{GS} = 80\%$ of Rated Value, $T_A = 150^\circ\text{C}$ , Time = 48 hours
Interim Electrical Tests (Note 9)	All Delta Parameters Listed in the Delta Tests and Limits Table	All Delta Parameters Listed in the Delta Tests and Limits Table
Steady State Reverse Bias (Drain Stress)	MIL-STD-750, Method 1042, Condition A $V_{DS} = 80\%$ of Rated Value, $T_A = 150^\circ\text{C}$ , Time = 160 hours	MIL-STD-750, Method 1042, Condition A $V_{DS} = 80\%$ of Rated Value, $T_A = 150^\circ\text{C}$ , Time = 240 hours
PDA	10%	5%
Final Electrical Tests (Note 9)	MIL-S-19500, Group A, Subgroup 2	MIL-S-19500, Group A, Subgroups 2 and 3

NOTE:

9. Test limits are identical pre and post burn-in.

### Additional Screening Tests

PARAMETER	SYMBOL	TEST CONDITIONS	MAX	UNITS
Safe Operating Area	SOA	$V_{DS} = -80\text{V}$ , $t = 10\text{ms}$	5.5	A
Unclamped Inductive Switching	$I_{AS}$	$V_{GS(PEAK)} = -15\text{V}$ , $L = 0.1\text{mH}$	141	A
Thermal Response	$\Delta V_{SD}$	$t_H = 10\text{ms}$ ; $V_H = -25\text{V}$ ; $I_H = 4\text{A}$	55	mV
Thermal Impedance	$\Delta V_{SD}$	$t_H = 500\text{ms}$ ; $V_H = -20\text{V}$ ; $I_H = 4\text{A}$ (HEATSINK REQUIRED)	115	mV

**Rad Hard Data Packages - Intersil Power Transistors**

**TXV Equivalent**

**1. Rad Hard TXV Equivalent - Standard Data Package**

- A. Certificate of Compliance
- B. Assembly Flow Chart
- C. Preconditioning - Attributes Data Sheet
- D. Group A - Attributes Data Sheet
- E. Group B - Attributes Data Sheet
- F. Group C - Attributes Data Sheet
- G. Group D - Attributes Data Sheet

**2. Rad Hard TXV Equivalent - Optional Data Package**

- A. Certificate of Compliance
- B. Assembly Flow Chart
- C. Preconditioning - Attributes Data Sheet
  - Precondition Lot Traveler
  - Pre and Post Burn-In Read and Record Data
- D. Group A - Attributes Data Sheet
  - Group A Lot Traveler
- E. Group B - Attributes Data Sheet
  - Group B Lot Traveler
  - Pre and Post Read and Record Data for Intermittent Operating Life (Subgroup B3)
  - Bond Strength Data (Subgroup B3)
  - Pre and Post High Temperature Operating Life Read and Record Data (Subgroup B6)
- F. Group C - Attributes Data Sheet
  - Group C Lot Traveler
  - Pre and Post Read and Record Data for Intermittent Operating Life (Subgroup C6)
  - Bond Strength Data (Subgroup C6)
- G. Group D - Attributes Data Sheet
  - Group D Lot Traveler
  - Pre and Post RAD Read and Record Data

**Class S - Equivalents**

**1. Rad Hard "S" Equivalent - Standard Data Package**

- A. Certificate of Compliance
- B. Serialization Records
- C. Assembly Flow Chart
- D. SEM Photos and Report

- E. Preconditioning Attributes Data Sheet
  - Hi-Rel Lot Traveler
  - HTRB - Hi Temp Gate Stress Post Reverse Bias Data and Delta Data
  - HTRB - Hi Temp Drain Stress Post Reverse Bias Delta Data

- F. Group A - Attributes Data Sheet
- G. Group B - Attributes Data Sheet
- H. Group C - Attributes Data Sheet
- I. Group D - Attributes Data Sheet

**2. Rad Hard Max. "S" Equivalent - Optional Data Package**

- A. Certificate of Compliance
- B. Serialization Records
- C. Assembly Flow Chart
- D. SEM Photos and Report
- E. Preconditioning - Attributes Data Sheet
  - Hi-Rel Lot Traveler
  - HTRB - Hi Temp Gate Stress Post Reverse Bias Data and Delta Data
  - HTRB - Hi Temp Drain Stress Post Reverse Bias Delta Data
  - X-Ray and X-Ray Report
- F. Group A - Attributes Data Sheet
  - Hi-Rel Lot Traveler
  - Subgroups A2, A3, A4, A5 and A7 Data
- G. Group B - Attributes Data Sheet
  - Hi-Rel Lot Traveler
  - Subgroups B1, B3, B4, B5 and B6 Data
- H. Group C - Attributes Data Sheet
  - Hi-Rel Lot Traveler
  - Subgroups C1, C2, C3 and C6 Data
- I. Group D - Attributes Data Sheet
  - Hi-Rel Lot Traveler
  - Pre and Post Radiation Data

## FSYC9160D, FSYC9160R

### SMD-2

#### 3 PAD CERAMIC LEADLESS CHIP CARRIER

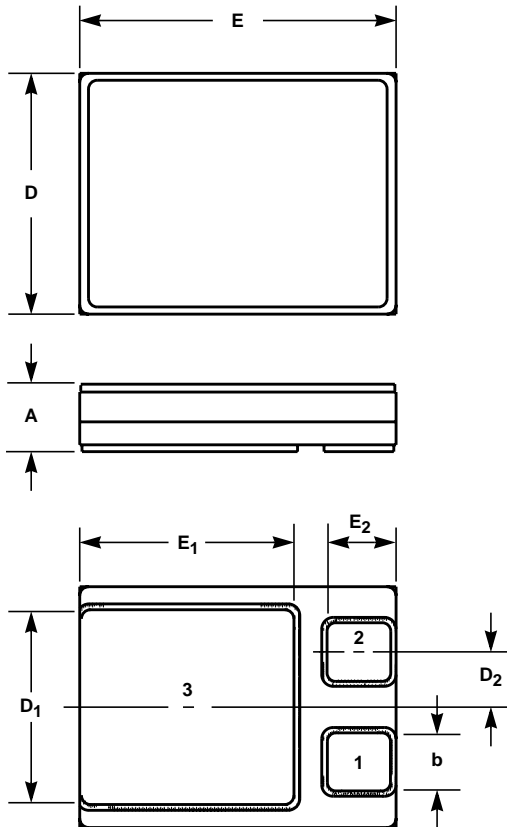

1 - GATE  
2 - SOURCE  
3 - DRAIN

SYMBOL	INCHES		MILLIMETERS		NOTES
	MIN	MAX	MIN	MAX	
A	0.129	0.139	3.27	3.53	-
b	0.135	0.145	3.43	3.68	-
D	0.520	0.530	13.20	13.46	-
D <sub>1</sub>	0.435	0.445	11.05	11.30	-
D <sub>2</sub>	0.115	0.125	2.92	3.17	-
E	0.685	0.695	17.40	17.65	-
E <sub>1</sub>	0.470	0.480	11.94	12.19	-
E <sub>2</sub>	0.152	0.162	3.86	4.11	-

**NOTES:**

1. No current JEDEC outline for this package.
2. Controlling dimension: INCH.
3. Revision 2 dated 6-98.

All Intersil semiconductor products are manufactured, assembled and tested under **ISO9000** quality systems certification.

*Intersil products are sold by description only. Intersil Corporation reserves the right to make changes in circuit design and/or specifications at any time without notice. Accordingly, the reader is cautioned to verify that data sheets are current before placing orders. Information furnished by Intersil is believed to be accurate and reliable. However, no responsibility is assumed by Intersil or its subsidiaries for its use; nor for any infringements of patents or other rights of third parties which may result from its use. No license is granted by implication or otherwise under any patent or patent rights of Intersil or its subsidiaries.*

For information regarding Intersil Corporation and its products, see web site <http://www.intersil.com>

### Sales Office Headquarters

**NORTH AMERICA**  
Intersil Corporation  
P. O. Box 883, Mail Stop 53-204  
Melbourne, FL 32902  
TEL: (407) 724-7000  
FAX: (407) 724-7240

**EUROPE**  
Intersil SA  
Mercure Center  
100, Rue de la Fusee  
1130 Brussels, Belgium  
TEL: (32) 2.724.2111  
FAX: (32) 2.724.22.05

**ASIA**  
Intersil (Taiwan) Ltd.  
Taiwan Limited  
7F-6, No. 101 Fu Hsing North Road  
Taipei, Taiwan  
Republic of China  
TEL: (886) 2 2716 9310  
FAX: (886) 2 2715 3029