

2.4GHz Power Amplifier and Detector



The HFA3983 is a 2.4GHz monolithic SiGe Power Amplifier designed to operate in the ISM Band. It features two low voltage single supply stages. Cascaded, they deliver a 18dBm (Typ.)

of an output power for the typical DSSS signal (ACPR, 1st Side Lobe < -30dBc, 2nd Side Lobe < -50dBc).

In addition, the device includes a 2.4GHz detector which is accurate over a 15dB of dynamic range with (±)1dB. Therefore, an accurate ALC function can be implemented.

The HFA3983 is housed in a 28 lead exposed paddle EPTSSOP package well suited for PCMCIA board applications.

Simplified Block Diagram

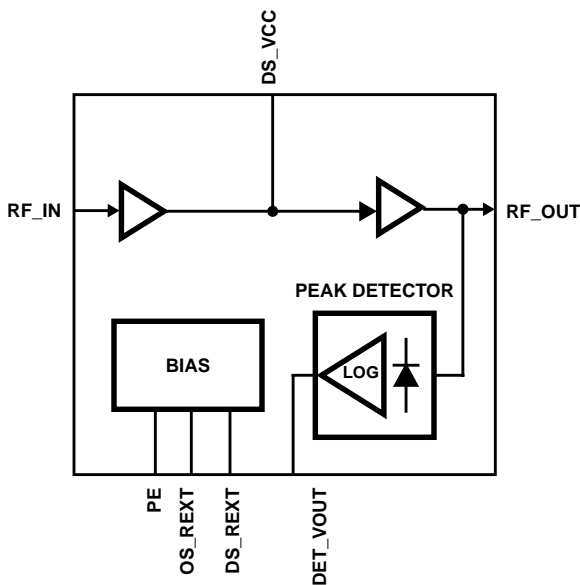

Features

- Single Supply 2.7V to 3.6V
- Output Power 18dBm (Typ) at ACPR, DSSS, 1st Side Lobe < -30dBc, 2nd Side Lobe < -50dBc
- Power Gain 30dB (Typ.)
- Detector Linear Input Power Range 15dB
- Detector Accuracy ±1.0dB

Applications

- IEEE802.11 1 and 2Mbps Standard
- Systems Targeting IEEE802.11, 11Mbps Standard
- Wireless Local Area Networks
- PCMCIA Wireless Transceivers
- ISM Systems Including Automatic Level Control (ALC)
- TDMA Packet Protocol Radios

Ordering Information

PART NUMBER	TEMP. RANGE (°C)	PACKAGE	PKG. NO.
HFA3983IV	-40 to 85	28 Ld EPTSSOP	M28.173A
HFA3983IV96	-40 to 85	Tape and Reel	

Pinout

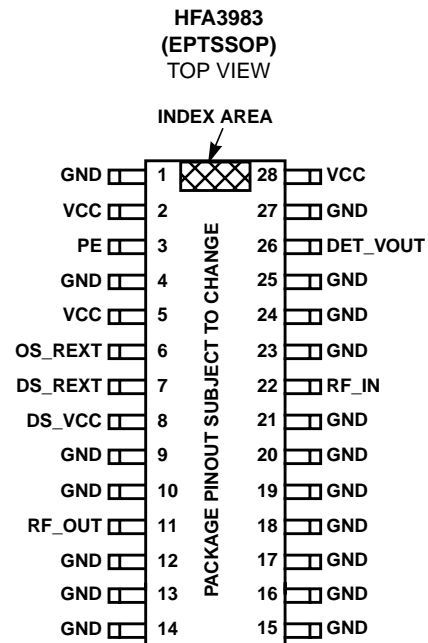

Pin Descriptions

PIN NUMBER	NAME	DESCRIPTION
1	GND	DC and RF Ground.
2	VCC	Power supply.
3	PE	Digital input control pin to enable the operation of the Power Amplifier. Enable logic level is High.
4	GND	DC and RF Ground.
5	VCC	Power supply.
6	OS_REXT	Output stage bias resistor, biasing scheme independent of absolute temperature.
7	DS_REXT	Driver stage bias resistor, biasing scheme independent of absolute temperature.
8	DS_VCC	Driver stage power supply.
9, 10	GND	DC and RF Ground.
11	RF_OUT	RF Output of the Power Amplifier.
12, 13, 14, 15, 16, 17, 18, 19, 20, 21	GND	DC and RF Ground.
22	RF_IN	RF Input of the Power Amplifier.
23, 24, 25	GND	DC and RF Ground.
26	DET_VOUT	Detector output.
27	GND	DC and RF Ground.
28	VCC	Power supply.

As part of the Prism II WLAN chip set, the HFA3983 works seamlessly with the chip set components to give you a highly integrated, cost effective 11Mb/s WLAN solution in the 2.4 to 2.5GHz ISM band. The HFA3983 is fabricated in the fastest SiGe BiCMOS process available, allowing superior RF performance, normally found only in GaAs ICs. Cost effective functions, normally requiring external components, are integrated into one IC. The HFA3983 integrates the following functions in one compact 28 pin EPTSSOP:

Two Stage, 30dB Gain RFPA,
 Logarithmic power detect function (15dB Dynamic Range),
 CMOS level compatible Power Up/Down function,
 Single Supply, 2.7V to 3.6V Operation.

The HFA3983 contains a highly linear RFPA designed to deliver 18dBm and meet an ACPR specification of -30dBc in the 2.4 to 2.5GHz ISM band. The performance of this two stage RFPA can be optimized by adjusting the bias current in each stage with a dedicated resistor. No external positive or negative power supplies are required to set the bias currents. The on chip bias network provides the optimum bias current temperature compensation when low TC external resistors are used. To get the best performance from the HFA3983, the output stage matching network can be tailored using external components.

The HFA3983 power detect function provides a DC output voltage that is proportional to the logarithm of the output power. For an output power of 18dBm, the detector is accurate to within a dB. The slope of the detector output

voltage is 100mV/dB over a 15dB dynamic range. A simple application of the detector is to provide in-line monitoring of the output power using a DC voltmeter. No longer is a power meter or spectrum analyzer required. A more value added application would use the HFA3861 Baseband Processor to dynamically monitor the HFA3983 output power and to control transmit power by adjusting the AGC of the HFA3783 IF Quadrature Modem to provide the best possible error free data transfer rate for any given environment. Closed loop power control is very important feature which compensates for variability in the transmit chain (radio to radio, channel to channel, over temperature...).

The HFA3983 power up/down feature integrates the power down capability onto the IC and requires no external components, thus freeing up board space and reducing external component count and cost. When the CMOS compatible PE (power enable) pin is driven low, the total supply current drops to under 200µA in, typically, 230nS. When the PE pin is driven high, the full HFA3983 output power is available in a few hundred nanoseconds.

In summary, the HFA3983 RFPA provides a highly cost effective solution for the PA function by integrating many features that would require significant development time, drive up the total bill of materials cost and consume precious board space. It interfaces seamlessly with the other Prism II ICs to provide a highly integrated, cost effective 11Mb/s WLAN solution in the 2.4 to 2.5GHz ISM band.

Absolute Maximum Ratings

Supply Voltage 4V
 Voltage on Any Other Pin -0.3 to V_{CC} +0.3V
 V_{CC} to V_{CC} Decouple -0.3 to +0.3V
 Any GND to GND -0.3 to +0.3V

Operating Conditions

Temperature Range -40 to 85°C
 Supply Voltage Range 2.7V to 3.6V

Thermal Information

Thermal Resistance (Typical, Note 1) θ_{JC} (°C/W)
 EPTSSOP Package 15
 Maximum Junction Temperature (Plastic Package) 150°C
 Maximum Storage Temperature Range -65°C to 150°C
 Maximum Lead Temperature (Soldering 10s) 300°C
 Moisture Sensitive Level (See Tech Brief 363) 72 Hrs (L4)

CAUTION: Stresses above those listed in "Absolute Maximum Ratings" may cause permanent damage to the device. This is a stress only rating and operation of the device at these or any other conditions above those indicated in the operational sections of this specification is not implied.

NOTE:

1. θ_{JC} is measured with the component mounted on an evaluation PC board in free air with the exposed paddle soldered to an infinite heatsink.

General DC Electrical Specifications

PARAMETER	TEMP. (°C)	MIN	TYP	MAX	UNITS
Supply Voltage	Full	2.7	-	3.6	V
Total Power Amplifier Supply Current at 3.3V, 18dBm Output	25	-	180	-	mA
RF Detector Supply Current	25	-	-	5	mA
Power Down Supply Current	Full	-	200	-	µA
Power Up/ Down Speed	Full	-	230	-	ns
CMOS Low Level Input Voltage	Full	-	-	0.3*V _{DD}	V
CMOS High Level Input Voltage (V _{DD} = 3.3V)	Full	0.7*V _{DD}	-	3.6	V
CMOS Threshold Voltage	Full	-	0.5*V _{DD}	-	V
CMOS High or Low Level Input Current	Full	-10	-	+10	µA

Power Amplifier AC Electrical Specifications V_{CC} = 3.3V, f = 2.45GHz, Unless Otherwise Specified. Typical Application Circuit (external input and output matching networks) has been used.

PARAMETER	TEST CONDITIONS	TEMP. (°C)	MIN	TYP	MAX	UNITS
RF Frequency Range		Full	2400	-	2500	MHz
Power/Voltage Gain		Full	28	30	32	dB
Noise Figure		Full	-	-	7	dB
Input 50Ω VSWR		25	-	-	2.00:1	-
Output 50Ω VSWR	Output matching network optimized for P1dB compression	25	-	-	3.00:1	-
Output Power	ACPR, DSSS, 1st Side Lobe <-30dBc, 2nd Side Lobe <-50dBc	Full	17	18		dBm
Output Stability VSWR	Output Spurs Less than -60dBc	Full	-	-	10:1	-
Output Load Mismatch	(Note 2)	Full	-	-	10:1	-

NOTE:

2. Devices sustain no damage when subjected to a mismatch of maximum 10:1.

Peak Detector AC Electrical Specifications

PARAMETER	TEST CONDITIONS	TEMP. (°C)	MIN	TYP	MAX	UNITS
RF Output Detector Response Time	External Capacitor, C = 5pF	Full	-	0.1	1	μs
RF Output Detector Voltage Range	Load > 1M	Full	0	-	1.5	V
RF Output Detector Linearity	Over Linear Range	Full	-0.5	-	+0.5	dB/V
RF Output Detector Accuracy	600mVDC Output	Full	-1	-	+1	dB
RF Output Detector Slope	Over Linear Range	Full	-	10	-	dB/V

HFA3983EVAL Board Schematic

TYPICAL APPLICATION EXAMPLE

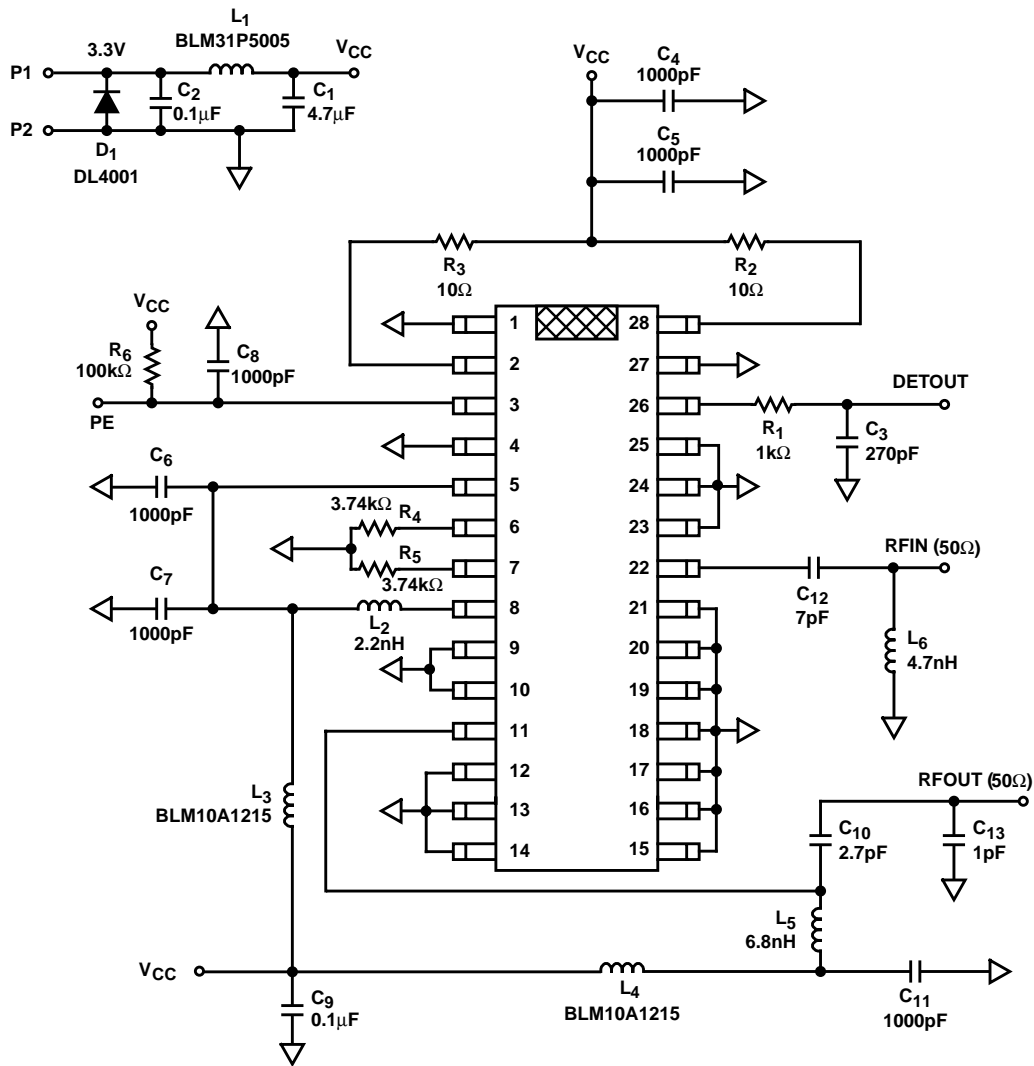

Typical Performance Curves

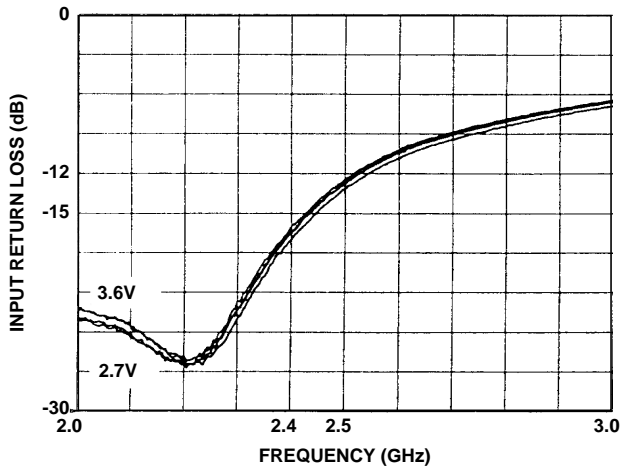

FIGURE 1. INPUT RETURN LOSS OVER VOLTAGE

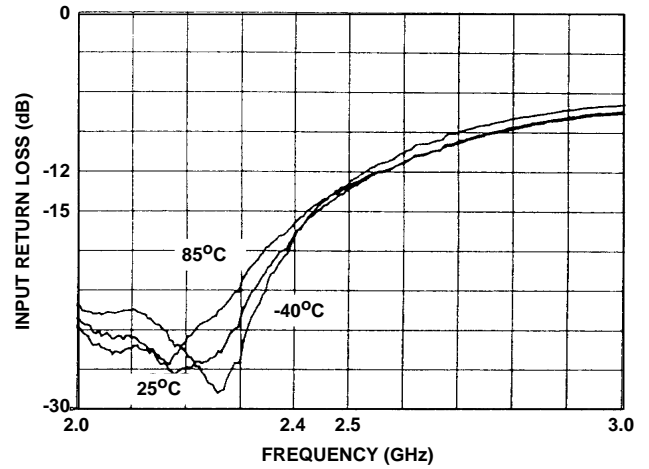

FIGURE 2. INPUT RETURN LOSS OVER TEMPERATURE

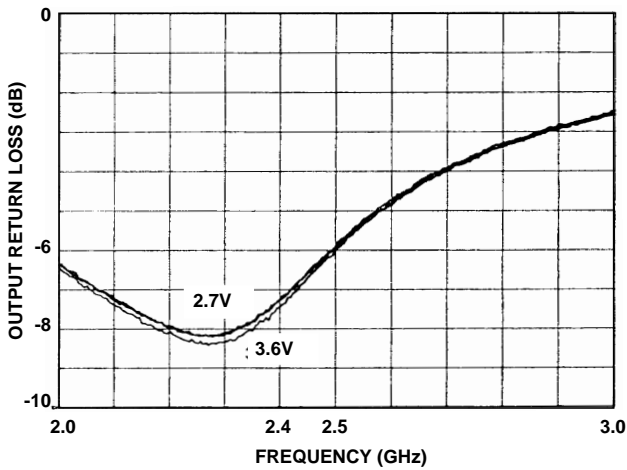

FIGURE 3. OUTPUT RETURN LOSS OVER VOLTAGE

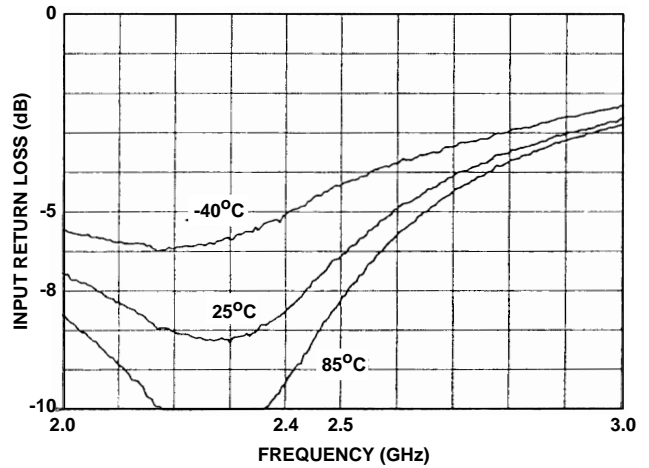

FIGURE 4. OUTPUT RETURN LOSS OVER TEMPERATURE

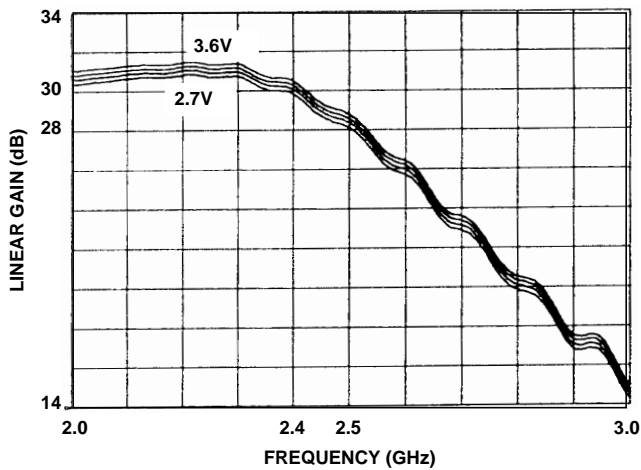

FIGURE 5. LINEAR GAIN OVER VOLTAGE

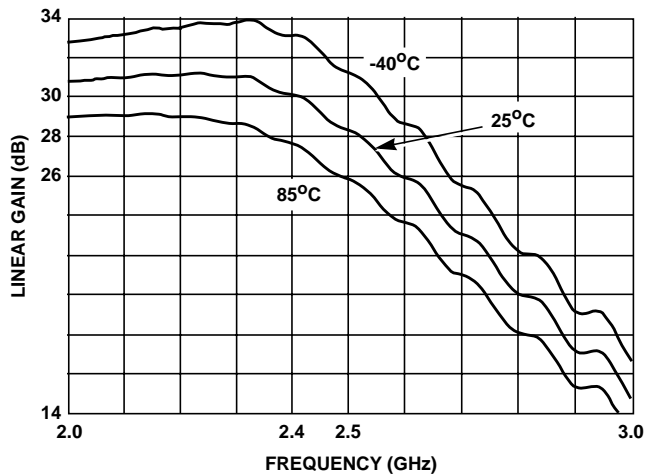

FIGURE 6. LINEAR GAIN OVER TEMPERATURE

Typical Performance Curves (Continued)

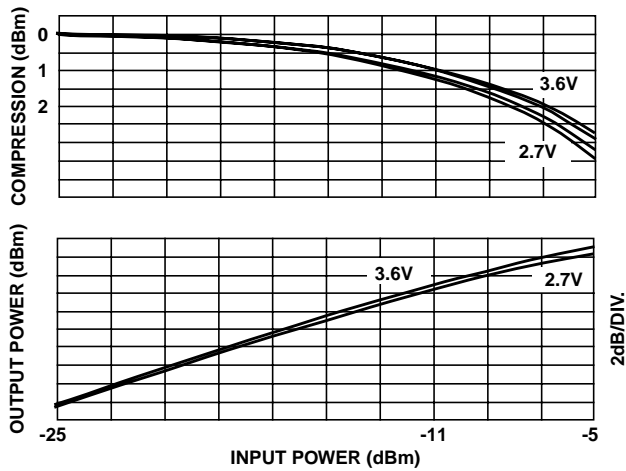

FIGURE 7. GAIN COMPRESSION OVER VOLTAGE

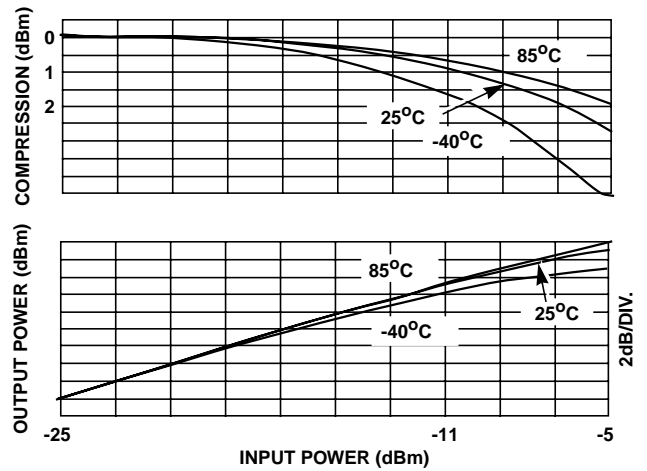

FIGURE 8. GAIN COMPRESSION OVER TEMPERATURE

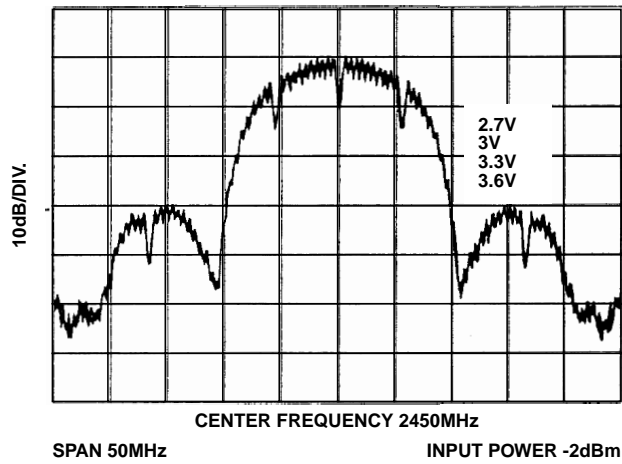

FIGURE 9. DSSS OUTPUT SIGNAL OVER VOLTAGE

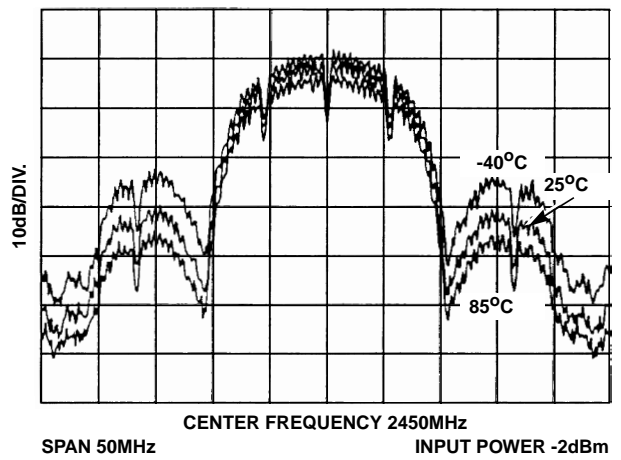

FIGURE 10. DSSS OUTPUT SIGNAL OVER TEMPERATURE

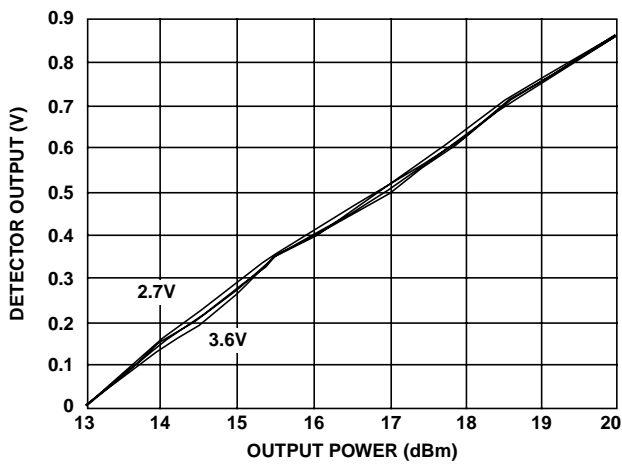

FIGURE 11. DETECTOR OUTPUT OVER VOLTAGE

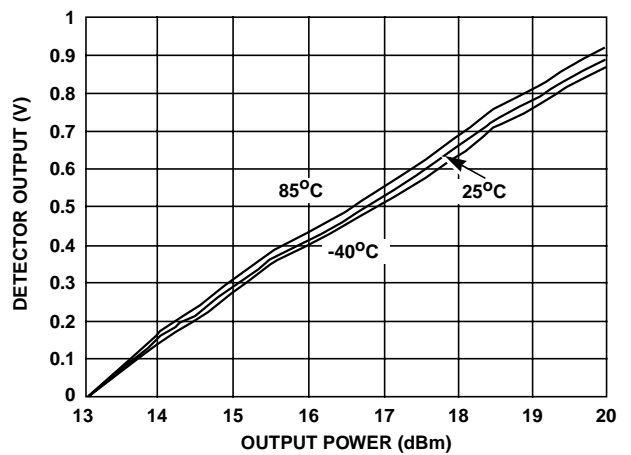
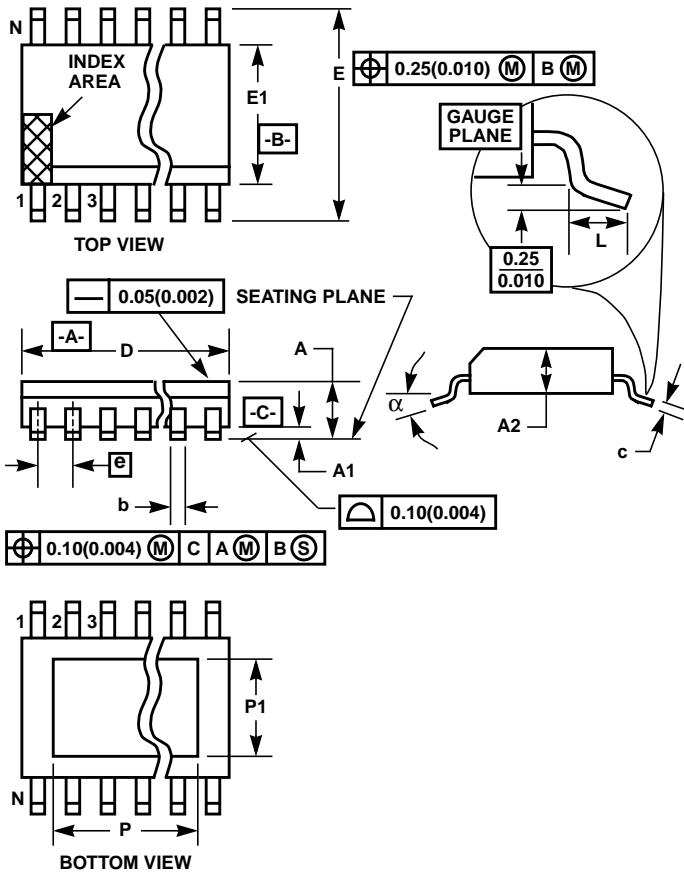

FIGURE 12. DETECTOR OUTPUT OVER TEMPERATURE

Thin Shrink Small Outline Exposed Pad Plastic Packages (EPTSSOP)



M28.173A

28 LEAD THIN SHRINK SMALL OUTLINE PLASTIC PACKAGE

SYMBOL	INCHES		MILLIMETERS		NOTES
	MIN	MAX	MIN	MAX	
A	-	0.047	-	1.20	-
A1	0.002	0.006	0.05	0.15	-
A2	0.031	0.051	0.80	1.05	-
b	0.0075	0.0118	0.19	0.30	9
c	0.0035	0.0079	0.09	0.20	-
D	0.378	0.386	9.60	9.80	3
E1	0.169	0.177	4.30	4.50	4
e	0.026 BSC		0.65 BSC		-
E	0.246	0.256	6.25	6.50	-
L	0.0177	0.0295	0.45	0.75	6
N	28		28		7
α	0°	8°	0°	8°	-
P	-	0.138	-	3.50	11
P1	-	0.118	-	3.0	11

NOTES:

Rev. 1 6/99

1. These package dimensions are within allowable dimensions of JEDEC MO-153-AET, Issue E.
2. Dimensioning and tolerancing per ANSI Y14.5M-1982.
3. Dimension "D" does not include mold flash, protrusions or gate burrs. Mold flash, protrusion and gate burrs shall not exceed 0.15mm (0.006 inch) per side.
4. Dimension "E1" does not include interlead flash or protrusions. Interlead flash and protrusions shall not exceed 0.15mm (0.006 inch) per side.
5. The chamfer on the body is optional. If it is not present, a visual index feature must be located within the crosshatched area.
6. "L" is the length of terminal for soldering to a substrate.
7. "N" is the number of terminal positions.
8. Terminal numbers are shown for reference only.
9. Dimension "b" does not include dambar protrusion. Allowable dambar protrusion shall be 0.08mm (0.003 inch) total in excess of "b" dimension at maximum material condition. Minimum space between protrusion and adjacent lead is 0.07mm (0.0027 inch).
10. Controlling dimension: MILLIMETER. Converted inch dimensions are not necessarily exact. (Angles in degrees)
11. Dimensions "P" and "P1" are thermal and/or electrical enhanced variations. Values shown are maximum size of exposed pad within lead count and body size.

All Intersil semiconductor products are manufactured, assembled and tested under **ISO9000** quality systems certification.

Intersil semiconductor products are sold by description only. Intersil Corporation reserves the right to make changes in circuit design and/or specifications at any time without notice. Accordingly, the reader is cautioned to verify that data sheets are current before placing orders. Information furnished by Intersil is believed to be accurate and reliable. However, no responsibility is assumed by Intersil or its subsidiaries for its use; nor for any infringements of patents or other rights of third parties which may result from its use. No license is granted by implication or otherwise under any patent or patent rights of Intersil or its subsidiaries.

For information regarding Intersil Corporation and its products, see web site www.intersil.com

Sales Office Headquarters

NORTH AMERICA

Intersil Corporation
 P. O. Box 883, Mail Stop 53-204
 Melbourne, FL 32902
 TEL: (321) 724-7000
 FAX: (321) 724-7240

EUROPE

Intersil SA
 Mercure Center
 100, Rue de la Fusee
 1130 Brussels, Belgium
 TEL: (32) 2.724.2111
 FAX: (32) 2.724.22.05

ASIA

Intersil (Taiwan) Ltd.
 7F-6, No. 101 Fu Hsing North Road
 Taipei, Taiwan
 Republic of China
 TEL: (886) 2 2716 9310
 FAX: (886) 2 2715 3029