

**Formerly Available As FSF450R4,
Radiation Hardened, SEGR Resistant,
N-Channel Power MOSFETs**

The Discrete Products Operation of Intersil has developed a series of Radiation Hardened MOSFETs specifically designed for commercial and military space applications. Enhanced Power MOSFET immunity to Single Event Effects (SEE), Single Event Gate Rupture (SEGR) in particular, is combined with 100K RADS of total dose hardness to provide devices which are ideally suited to harsh space environments. The dose rate and neutron tolerance necessary for military applications have not been sacrificed.

The Intersil portfolio of SEGR resistant radiation hardened MOSFETs includes N-Channel and P-Channel devices in a variety of voltage, current and on-resistance ratings. Numerous packaging options are also available.

This MOSFET is an enhancement-mode silicon-gate power field-effect transistor of the vertical DMOS (VDMOS) structure. It is specially designed and processed to be radiation tolerant. The MOSFET is well suited for applications exposed to radiation environments such as switching regulation, switching converters, motor drives, relay drivers and drivers for high-power bipolar switching transistors requiring high speed and low gate drive power. This type can be operated directly from integrated circuits.

Also available at other radiation and screening levels. See us on the web, Intersil' home page:
<http://www.semi.intersil.com>. Contact your local Intersil Sales Office for additional information.

Ordering Information

PART NUMBER	PACKAGE	BRAND
JANSR2N7408	TO-254AA	JANSR2N7408

Die Family TA17659.

MIL-PRF-19500/634.

Features

- 9A, 500V, $r_{DS(ON)} = 0.600\Omega$
- Total Dose
 - Meets Pre-RAD Specifications to 100K RAD (Si)
- Single Event
 - Safe Operating Area Curve for Single Event Effects
 - SEE Immunity for LET of 36MeV/mg/cm^2 with V_{DS} up to 80% of Rated Breakdown and V_{GS} of 10V Off-Bias
- Dose Rate
 - Typically Survives $3E9$ RAD (Si)/s at 80% BV_{DSS}
 - Typically Survives $2E12$ if Current Limited to I_{DM}
- Photo Current
 - 30nA Per-RAD(Si)/s Typically
- Neutron
 - Maintain Pre-RAD Specifications for $3E12$ Neutrons/cm²
- Usable to $3E13$ Neutrons/cm²

Symbol

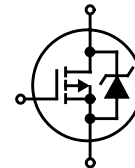

Packaging

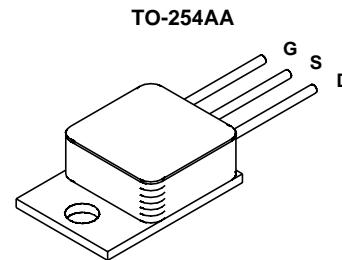

CAUTION: Beryllia Warning per MIL-S-19500 refer to package specifications.

JANSR2N7408

Absolute Maximum Ratings $T_C = 25^\circ\text{C}$, Unless Otherwise Specified

	JANSR2N7408	UNITS
Drain to Source Voltage	500	V
Drain to Gate Voltage ($R_{GS} = 20k\Omega$)	500	V
Continuous Drain Current		
$T_C = 25^\circ\text{C}$	9	A
$T_C = 100^\circ\text{C}$	6	A
Pulsed Drain Current	27	A
Gate to Source Voltage	± 20	V
Maximum Power Dissipation		
$T_C = 25^\circ\text{C}$	125	W
$T_C = 100^\circ\text{C}$	50	W
Linear Derating Factor	1.00	W/ $^\circ\text{C}$
Single Pulsed Avalanche Current, $L = 100\mu\text{H}$, (See Test Figure)	27	A
Continuous Source Current (Body Diode)	9	A
Pulsed Source Current (Body Diode)	27	A
Operating and Storage Temperature	-55 to 150	$^\circ\text{C}$
Lead Temperature (During Soldering)	300	$^\circ\text{C}$
(Distance $>0.063\text{in}$ (1.6mm) from Case, 10s Max)		
Weight (Typical)	9.3	g

CAUTION: Stresses above those listed in "Absolute Maximum Ratings" may cause permanent damage to the device. This is a stress only rating and operation of the device at these or any other conditions above those indicated in the operational sections of this specification is not implied.

Electrical Specifications $T_C = 25^\circ\text{C}$, Unless Otherwise Specified

PARAMETER	SYMBOL	TEST CONDITIONS	MIN	TYP	MAX	UNITS	
Drain to Source Breakdown Voltage	BV_{DSS}	$I_D = 1\text{mA}$, $V_{GS} = 0\text{V}$	500	-	-	V	
Gate Threshold Voltage	$V_{GS(TH)}$	$V_{GS} = V_{DS}$, $I_D = 1\text{mA}$	$T_C = -55^\circ\text{C}$	-	-	5.0	V
			$T_C = 25^\circ\text{C}$	1.5	-	4.0	V
			$T_C = 125^\circ\text{C}$	0.5	-	-	V
Zero Gate Voltage Drain Current	I_{DSS}	$V_{DS} = 400\text{V}$, $V_{GS} = 0\text{V}$	$T_C = 25^\circ\text{C}$	-	-	25	μA
			$T_C = 125^\circ\text{C}$	-	-	250	μA
Gate to Source Leakage Current	I_{GSS}	$V_{GS} = \pm 20\text{V}$	$T_C = 25^\circ\text{C}$	-	-	100	nA
			$T_C = 125^\circ\text{C}$	-	-	200	nA
Drain to Source On-State Voltage	$V_{DS(ON)}$	$V_{GS} = 12\text{V}$, $I_D = 9\text{A}$	-	-	5.67	V	
Drain to Source On Resistance	$r_{DS(ON)12}$	$I_D = 6\text{A}$, $V_{GS} = 12\text{V}$	$T_C = 25^\circ\text{C}$	-	0.425	0.600	Ω
			$T_C = 125^\circ\text{C}$	-	-	1.20	Ω
Turn-On Delay Time	$t_{d(ON)}$	$V_{DD} = 250\text{V}$, $I_D = 9\text{A}$, $R_L = 27.8\Omega$, $V_{GS} = 12\text{V}$, $R_{GS} = 2.35\Omega$	-	-	150	ns	
Rise Time	t_r		-	-	140	ns	
Turn-Off Delay Time	$t_{d(OFF)}$		-	-	180	ns	
Fall Time	t_f		-	-	70	ns	
Total Gate Charge (Not on slash sheet)	$Q_g(TOT)$	$V_{GS} = 0\text{V}$ to 20V	$V_{DD} = 250\text{V}$, $I_D = 9\text{A}$	-	-	220	nC
Gate Charge at 12V	$Q_g(12)$	$V_{GS} = 0\text{V}$ to 12V		-	110	150	nC
Threshold Gate Charge (Not on slash sheet)	$Q_g(TH)$	$V_{GS} = 0\text{V}$ to 2V		-	-	8.2	nC
Gate Charge Source	Q_{gs}			-	21	28	nC
Gate Charge Drain	Q_{gd}			-	49	62	nC
Thermal Resistance Junction to Case	$R_{\theta JC}$		-	-	1.00	$^\circ\text{C/W}$	
Thermal Resistance Junction to Ambient	$R_{\theta JA}$		-	-	48	$^\circ\text{C/W}$	

Source to Drain Diode Specifications

PARAMETER	SYMBOL	TEST CONDITIONS	MIN	TYP	MAX	UNITS
Forward Voltage	V_{SD}	$I_{SD} = 9A$	0.6	-	1.8	V
Reverse Recovery Time	t_{rr}	$I_{SD} = 9A, dI_{SD}/dt = 100A/\mu s$	-	-	810	ns

Electrical Specifications up to 100K RAD $T_C = 25^\circ C$, Unless Otherwise Specified

PARAMETER	SYMBOL	TEST CONDITIONS	MIN	MAX	UNITS
Drain to Source Breakdown Volts (Note 3)	BV_{DSS}	$V_{GS} = 0, I_D = 1mA$	500	-	V
Gate to Source Threshold Volts (Note 3)	$V_{GS(TH)}$	$V_{GS} = V_{DS}, I_D = 1mA$	1.5	4.0	V
Gate to Body Leakage (Notes 2, 3)	I_{GSS}	$V_{GS} = \pm 20V, V_{DS} = 0V$	-	100	nA
Zero Gate Leakage (Note 3)	I_{DSS}	$V_{GS} = 0, V_{DS} = 400V$	-	25	μA
Drain to Source On-State Volts (Notes 1, 3)	$V_{DS(ON)}$	$V_{GS} = 12V, I_D = 9A$	-	5.67	V
Drain to Source On Resistance (Notes 1, 3)	$r_{DS(ON)12}$	$V_{GS} = 12V, I_D = 6A$	-	0.600	Ω

NOTES:

1. Pulse test, 300 μs Max.
2. Absolute value.
3. Insitu Gamma bias must be sampled for both $V_{GS} = 12V, V_{DS} = 0V$ and $V_{GS} = 0V, V_{DS} = 80\% BV_{DSS}$.

Single Event Effects (SEB, SEGR) Note 4

TEST	SYMBOL	ENVIRONMENT (NOTE 5)			APPLIED V_{GS} BIAS (V)	(NOTE 6) MAXIMUM V_{DS} BIAS (V)
		ION SPECIES	TYPICAL LET (MeV/mg/cm)	TYPICAL RANGE (μ)		
Single Event Effects Safe Operating Area	SEESOAS	Ni	26	43	-15	500
		Ni	26	43	-20	450
		Br	37	36	-5	500
		Br	37	36	-10	400
		Br	37	36	-15	100

NOTES:

4. Testing conducted at Brookhaven National Labs; sponsored by Naval Surface Warfare Center (NSWC), Crane, IN.
5. Fluence = 1E5 ions/cm² (typical), $T_C = 25^\circ C$.
6. Does not exhibit Single Event Burnout (SEB) or Single Event Gate Rupture (SEGR).

Typical Performance Curves Unless Otherwise Specified

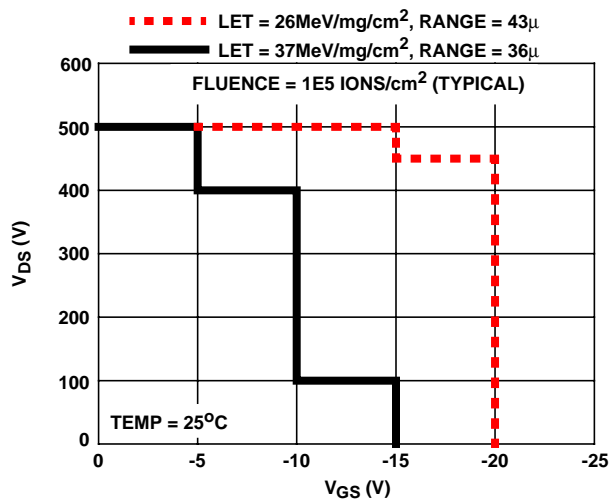

FIGURE 1. SINGLE EVENT EFFECTS SAFE OPERATING AREA

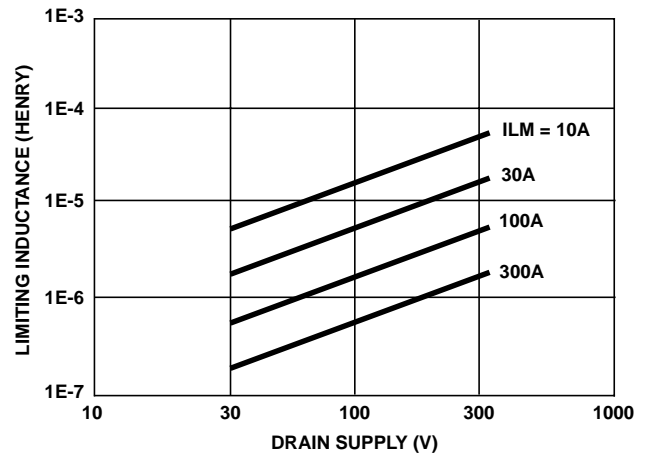

FIGURE 2. DRAIN INDUCTANCE REQUIRED TO LIMIT GAMMA DOT CURRENT TO I_{AS}

Typical Performance Curves Unless Otherwise Specified (Continued)

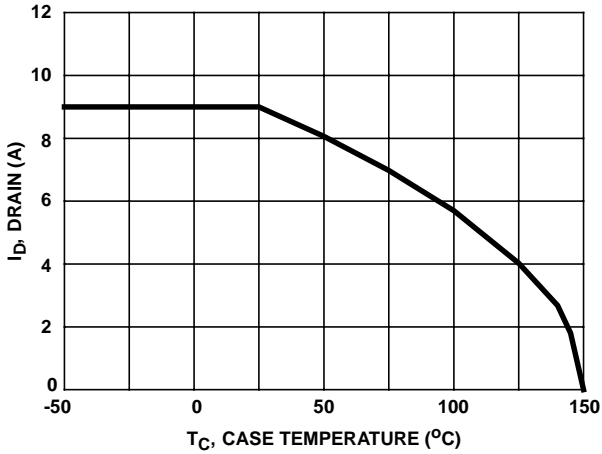

FIGURE 3. MAXIMUM CONTINUOUS DRAIN CURRENT vs TEMPERATURE

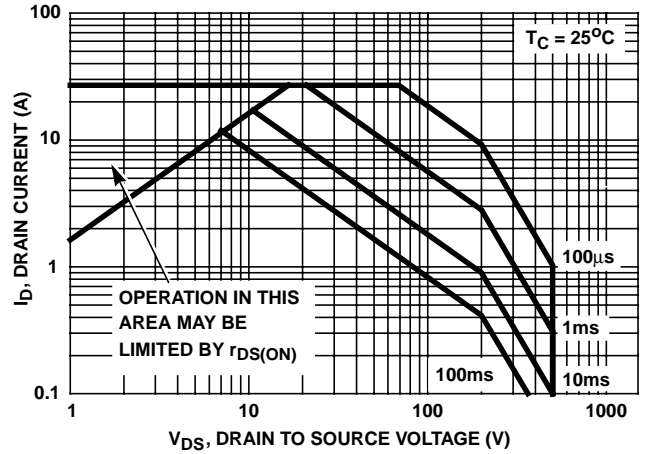

FIGURE 4. FORWARD BIAS SAFE OPERATING AREA

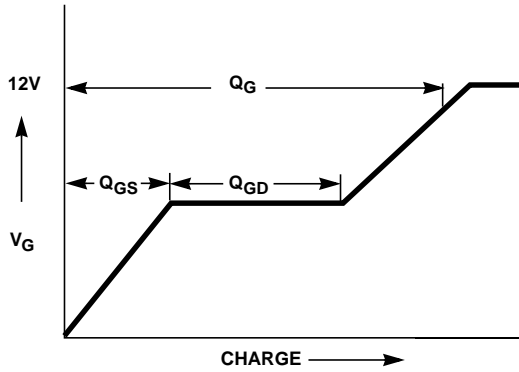

FIGURE 5. BASIC GATE CHARGE WAVEFORM

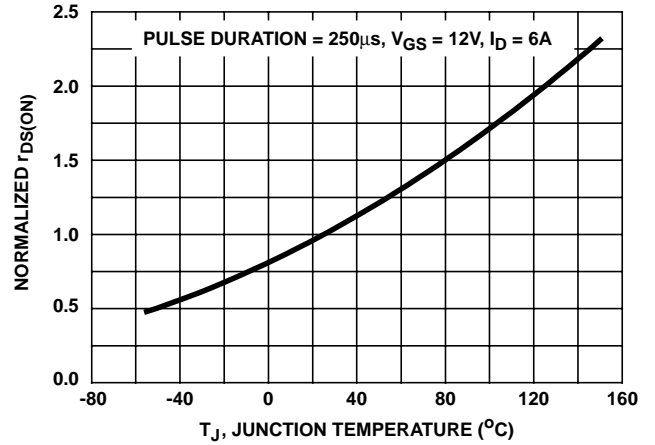

FIGURE 6. NORMALIZED $r_{DS(ON)}$ vs JUNCTION TEMPERATURE

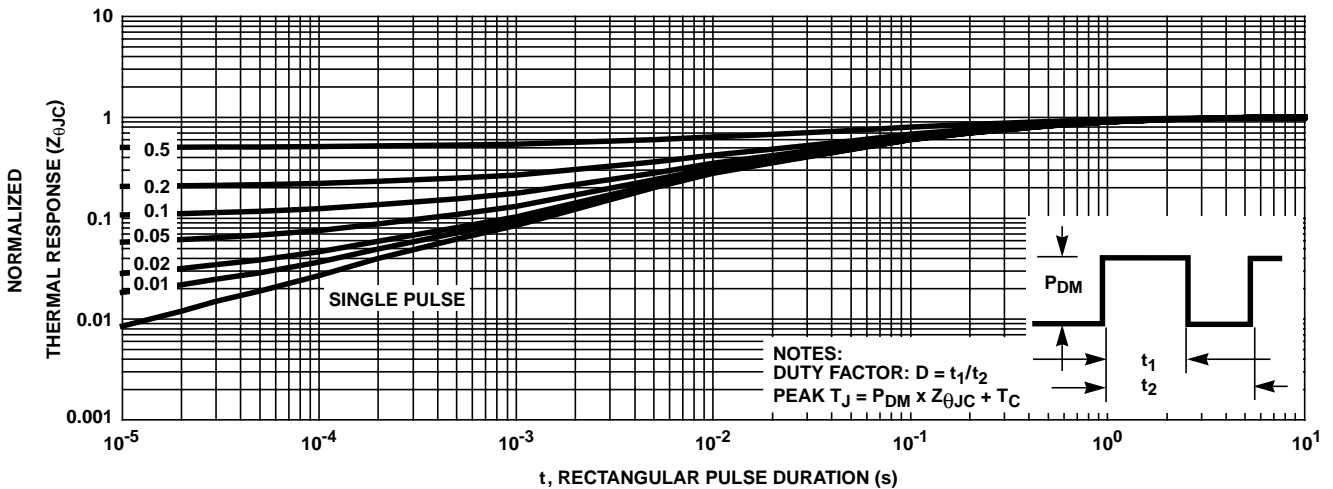

FIGURE 7. NORMALIZED MAXIMUM TRANSIENT THERMAL RESPONSE

Typical Performance Curves Unless Otherwise Specified (Continued)

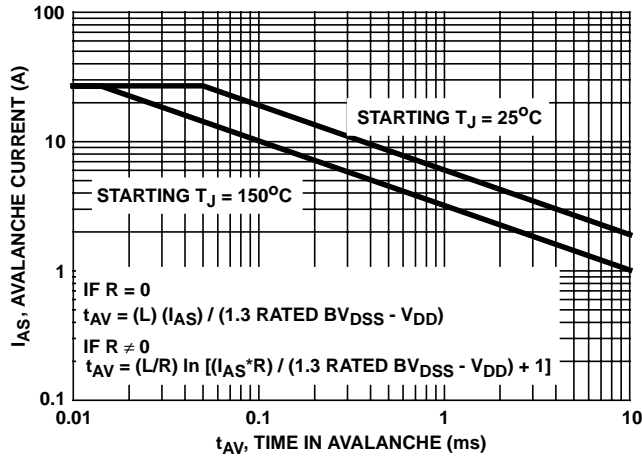

FIGURE 8. UNCLAMPED INDUCTIVE SWITCHING

Test Circuits and Waveforms

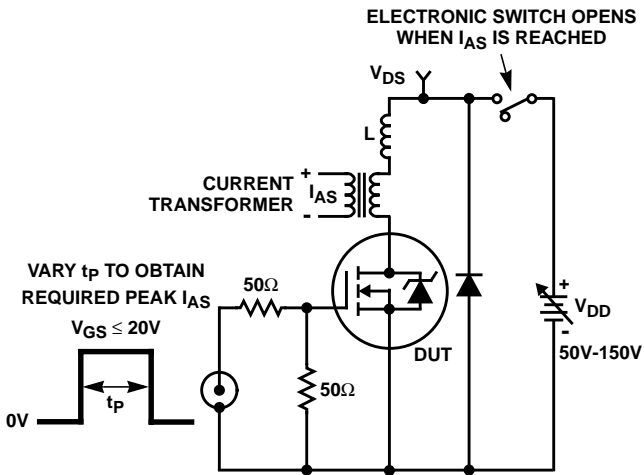

FIGURE 9. UNCLAMPED ENERGY TEST CIRCUIT

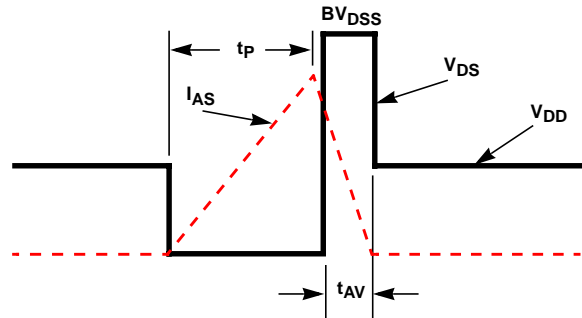

FIGURE 10. UNCLAMPED ENERGY WAVEFORMS

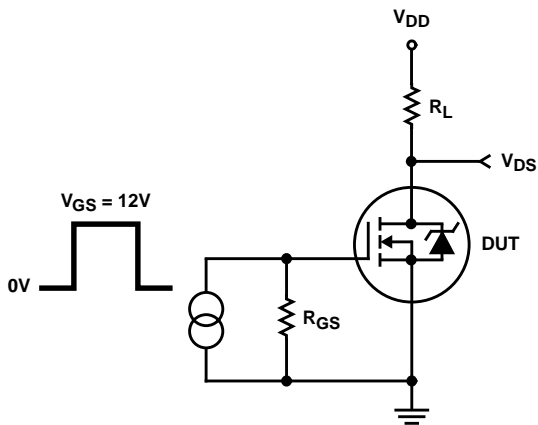

FIGURE 11. RESISTIVE SWITCHING TEST CIRCUIT

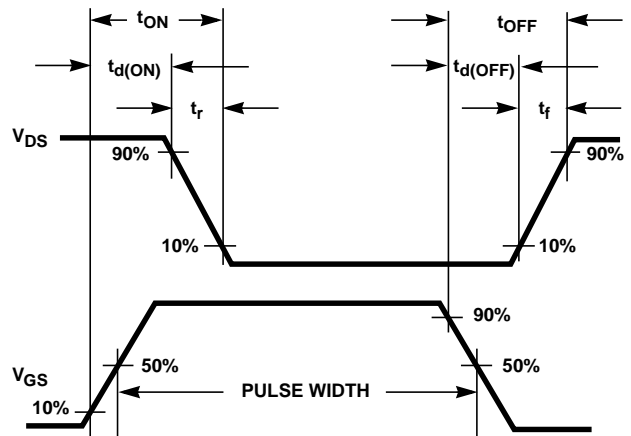

FIGURE 12. RESISTIVE SWITCHING WAVEFORMS

Screening Information

Screening is performed in accordance with the latest revision in effect of MIL-S-19500, (Screening Information Table).

Delta Tests and Limits (JANS) $T_C = 25^\circ\text{C}$, Unless Otherwise Specified

PARAMETER	SYMBOL	TEST CONDITIONS	MAX	UNITS
Gate to Source Leakage Current	I_{GSS}	$V_{GS} = \pm 20\text{V}$	± 20 (Note 7)	nA
Zero Gate Voltage Drain Current	I_{DSS}	$V_{DS} = 80\%$ Rated Value	± 25 (Note 7)	μA
Drain to Source On Resistance	$r_{DS(ON)}$	$T_C = 125^\circ\text{C}$ at Rated I_D	$\pm 20\%$ (Note 8)	Ω
Gate Threshold Voltage	$V_{GS(TH)}$	$I_D = 1.0\text{mA}$	$\pm 20\%$ (Note 8)	V

NOTES:

- 7. Or 100% of Initial Reading (whichever is greater).
- 8. Of Initial Reading.

Screening Information

TEST	JANS
Gate Stress	$V_{GS} = 30\text{V}$, $t = 250\mu\text{s}$
Pind	Required
Pre Burn-In Tests (Note 9)	MIL-S-19500 Group A, Subgroup 2 (All Static Tests at 25°C)
Steady State Gate Bias (Gate Stress)	MIL-STD-750, Method 1042, Condition B $V_{GS} = 80\%$ of Rated Value, $T_A = 150^\circ\text{C}$, Time = 48 hours
Interim Electrical Tests (Note 9)	All Delta Parameters Listed in the Delta Tests and Limits Table
Steady State Reverse Bias (Drain Stress)	MIL-STD-750, Method 1042, Condition A $V_{DS} = 80\%$ of Rated Value, $T_A = 150^\circ\text{C}$, Time = 240 hours
PDA	5%
Final Electrical Tests (Note 9)	MIL-S-19500, Group A, Subgroups 2 and 3

NOTE:

- 9. Test limits are identical pre and post burn-in.

Additional Screening Tests

PARAMETER	SYMBOL	TEST CONDITIONS	MAX	UNITS
Safe Operating Area	SOA	$V_{DS} = _V$, $t = 10\text{ms}$	0.90	A
Unclamped Inductive Switching	I_{AS}	$V_{GS(PEAK)} = 15\text{V}$, $L = 0.1\text{mH}$	27	A
Thermal Response	ΔV_{SD}	$t_H = 100\text{ms}$; $V_H = 25\text{V}$; $I_H = 4\text{A}$	136	mV
Thermal Impedance	ΔV_{SD}	$t_H = 500\text{ms}$; $V_H = 25\text{V}$; $I_H = 4\text{A}$	187	mV

Rad Hard Data Packages - Intersil Power Transistors

1. JANS Rad Hard - Standard Data Package

- A. Certificate of Compliance
- B. Serialization Records
- C. Assembly Flow Chart
- D. SEM Photos and Report
- E. Preconditioning - Attributes Data Sheet
 - Hi-Rel Lot Traveler
 - HTRB - Hi Temp Gate Stress Post Reverse Bias Data and Delta Data
 - HTRB - Hi Temp Drain Stress Post Reverse Bias Delta Data
- F. Group A - Attributes Data Sheet
- G. Group B - Attributes Data Sheet
- H. Group C - Attributes Data Sheet
- I. Group D - Attributes Data Sheet

2. JANS Rad Hard - Optional Data Package

- A. Certificate of Compliance
- B. Serialization Records
- C. Assembly Flow Chart
- D. SEM Photos and Report
- E. Preconditioning - Attributes Data Sheet
 - Hi-Rel Lot Traveler
 - HTRB - Hi Temp Gate Stress Post Reverse Bias Data and Delta Data
 - HTRB - Hi Temp Drain Stress Post Reverse Bias Delta Data
 - X-Ray and X-Ray Report
- F. Group A
 - Attributes Data Sheet
 - Hi-Rel Lot Traveler
 - Subgroups A2, A3, A4, A5 and A7 Data
- G. Group B
 - Attributes Data Sheet
 - Hi-Rel Lot Traveler
 - Subgroups B1, B3, B4, B5 and B6 Data
- H. Group C
 - Attributes Data Sheet
 - Hi-Rel Lot Traveler
 - Subgroups C1, C2, C3 and C6 Data
- I. Group D
 - Attributes Data Sheet
 - Hi-Rel Lot Traveler
 - Pre and Post Radiation Data

TO-254AA

3 LEAD JEDEC TO-254AA HERMETIC METAL PACKAGE

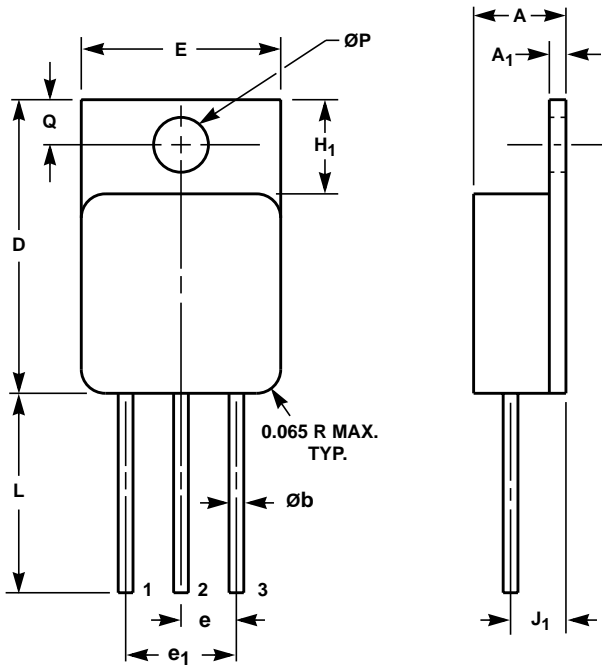

SYMBOL	INCHES		MILLIMETERS		NOTES
	MIN	MAX	MIN	MAX	
A	0.249	0.260	6.33	6.60	-
A ₁	0.040	0.050	1.02	1.27	-
Øb	0.035	0.045	0.89	1.14	2, 3
D	0.790	0.800	20.07	20.32	-
E	0.535	0.545	13.59	13.84	-
e	0.150 TYP		3.81 TYP		4
e ₁	0.300 BSC		7.62 BSC		4
H ₁	0.245	0.265	6.23	6.73	-
J ₁	0.140	0.160	3.56	4.06	4
L	0.520	0.560	13.21	14.22	-
ØP	0.139	0.149	3.54	3.78	-
Q	0.110	0.130	2.80	3.30	-

NOTES:

1. These dimensions are within allowable dimensions of Rev. A of JEDEC outline TO-254AA dated 11-86.
2. Add typically 0.002 inches (0.05mm) for solder coating.
3. Lead dimension (without solder).
4. Position of lead to be measured 0.250 inches (6.35mm) from bottom of dimension D.
5. Die to base BeO isolated, terminals to case ceramic isolated.
6. Controlling dimension: Inch.
7. Revision 1 dated 1-93.

WARNING!

BERYLLIA WARNING PER MIL-S-19500

Packages containing beryllium oxide (BeO) shall not be ground, machined, sandblasted, or subject to any mechanical operation which will produce dust containing any beryllium compound. Packages containing any beryllium compound shall not be subjected to any chemical process (etching, etc.) which will produce fumes containing beryllium or its' compounds.

All Intersil semiconductor products are manufactured, assembled and tested under **ISO9000** quality systems certification.

Intersil semiconductor products are sold by description only. Intersil Corporation reserves the right to make changes in circuit design and/or specifications at any time without notice. Accordingly, the reader is cautioned to verify that data sheets are current before placing orders. Information furnished by Intersil is believed to be accurate and reliable. However, no responsibility is assumed by Intersil or its subsidiaries for its use; nor for any infringements of patents or other rights of third parties which may result from its use. No license is granted by implication or otherwise under any patent or patent rights of Intersil or its subsidiaries.

For information regarding Intersil Corporation and its products, see web site www.intersil.com

Sales Office Headquarters

NORTH AMERICA

Intersil Corporation
 P. O. Box 883, Mail Stop 53-204
 Melbourne, FL 32902
 TEL: (407) 724-7000
 FAX: (407) 724-7240

EUROPE

Intersil SA
 Mercure Center
 100, Rue de la Fusee
 1130 Brussels, Belgium
 TEL: (32) 2.724.2111
 FAX: (32) 2.724.22.05

ASIA

Intersil (Taiwan) Ltd.
 7F-6, No. 101 Fu Hsing North Road
 Taipei, Taiwan
 Republic of China
 TEL: (886) 2 2716 9310
 FAX: (886) 2 2715 3029