

## Dual PCI Hot Plug Controller

The HIP1011D is the first IC available for independent control of two PCI Hot Plug slots. The HIP1011D has all the features and functionality of two single PCI Hot Plug slot controllers such as the HIP1011A but in the same foot print area.

The HIP1011D is designed to be physically placed in close proximity to two adjacent PCI slots servicing each independently but reducing layout complexity and placement costs in assembly. It creates two independent power control solutions with discrete power MOSFETs and a few passive components. The four supplies +5V, +3.3V, +12V, and -12V for each slot are independently controlled. There are four integrated current sensing switches for the +12V and -12V and for the +5V and +3.3V supplies overcurrent protection is provided by sensing the voltage across external current-sense resistors. In addition, on-chip references are used to monitor the +5V, +3.3V and +12V outputs for undervoltage conditions. The two PWRON inputs control the state of the switches, one each for slot A and slot B outputs. During an overcurrent condition on any output, or an undervoltage condition on the +5V, +3.3V or +12V outputs, a LOW (0V) is asserted on the associated FLTN output and all associated switches are latched-off. The outputs servicing the adjacent slot are unaffected.

The time to FLTN signal going LOW and MOSFET latch off is user determined by a single capacitor from each FLTN pin to ground. This added feature enables the HIP1011D to ignore system noise transients. The FLTN latch is cleared when the PWRON input is toggled low again. During initial power-up of the main VCC supply (+12V), the PWRON input is inhibited from turning on the switches, and the latch is held in the Reset state until the VCC input is greater than 10V.

User programmability of the overcurrent threshold and turn-on slew rate is provided. A resistor connected to the OCSET pin programs the overcurrent threshold for both slots. Capacitors connected to the gate pins set the turn-on rate.

## Features

- Independent Power Control of 2 PCI Slots
- Turn-Off Delay Time Adjustability
- Internal MOSFET Switches for +12V and -12V Outputs
- $\mu$ P Interface for On/Off Control and Fault Reporting
- Adjustable Overcurrent Protection for All Eight Supplies
- Provides Fault Isolation
- Adjustable Turn-On Slew Rate
- Minimum Parts Count Solution
- No Charge Pump
- 100ns Response Time to Over Current

## Applications

- PCI Hot-Plug

## Ordering Information

| PART NUMBER  | TEMP. RANGE (°C) | PACKAGE       | PKG. NO. |
|--------------|------------------|---------------|----------|
| HIP1011DCA   | 0 to 70          | 28 Ld SSOP    | M28.15   |
| HIP1011DCA-T | 0 to 70          | Tape and Reel |          |

## Pinout

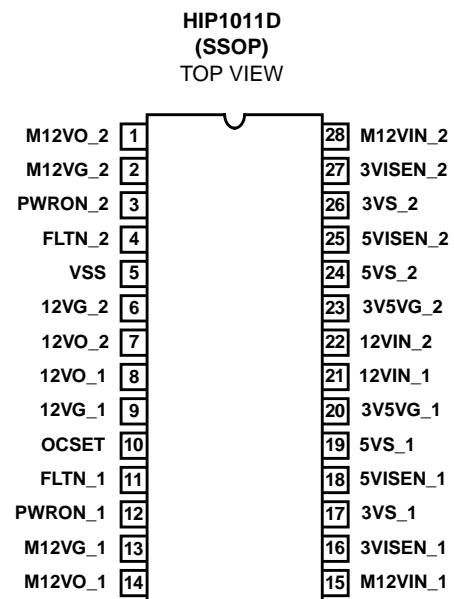

Typical Application

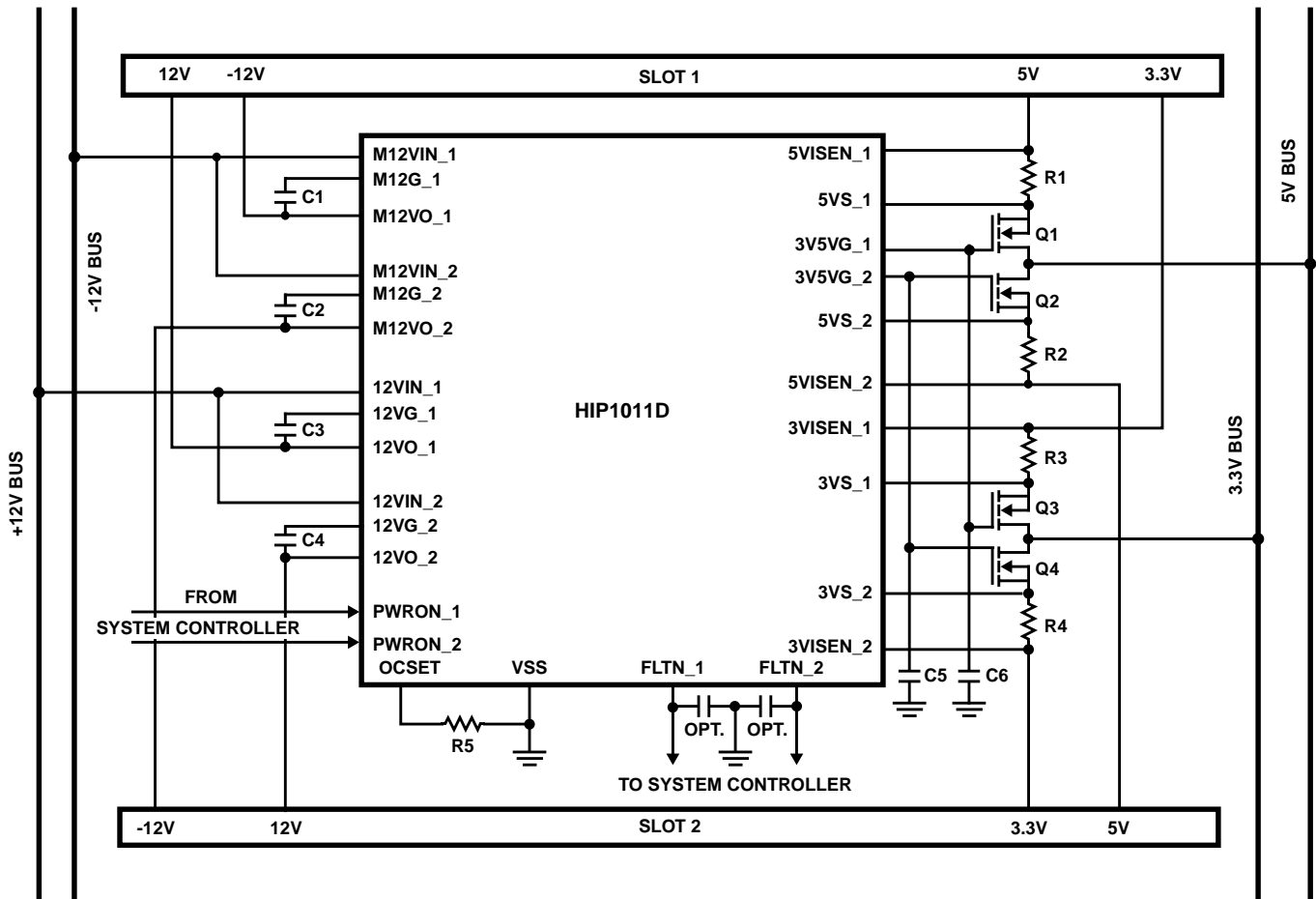

FIGURE 1.

Simplified Schematic (1/2 HIP1011D)

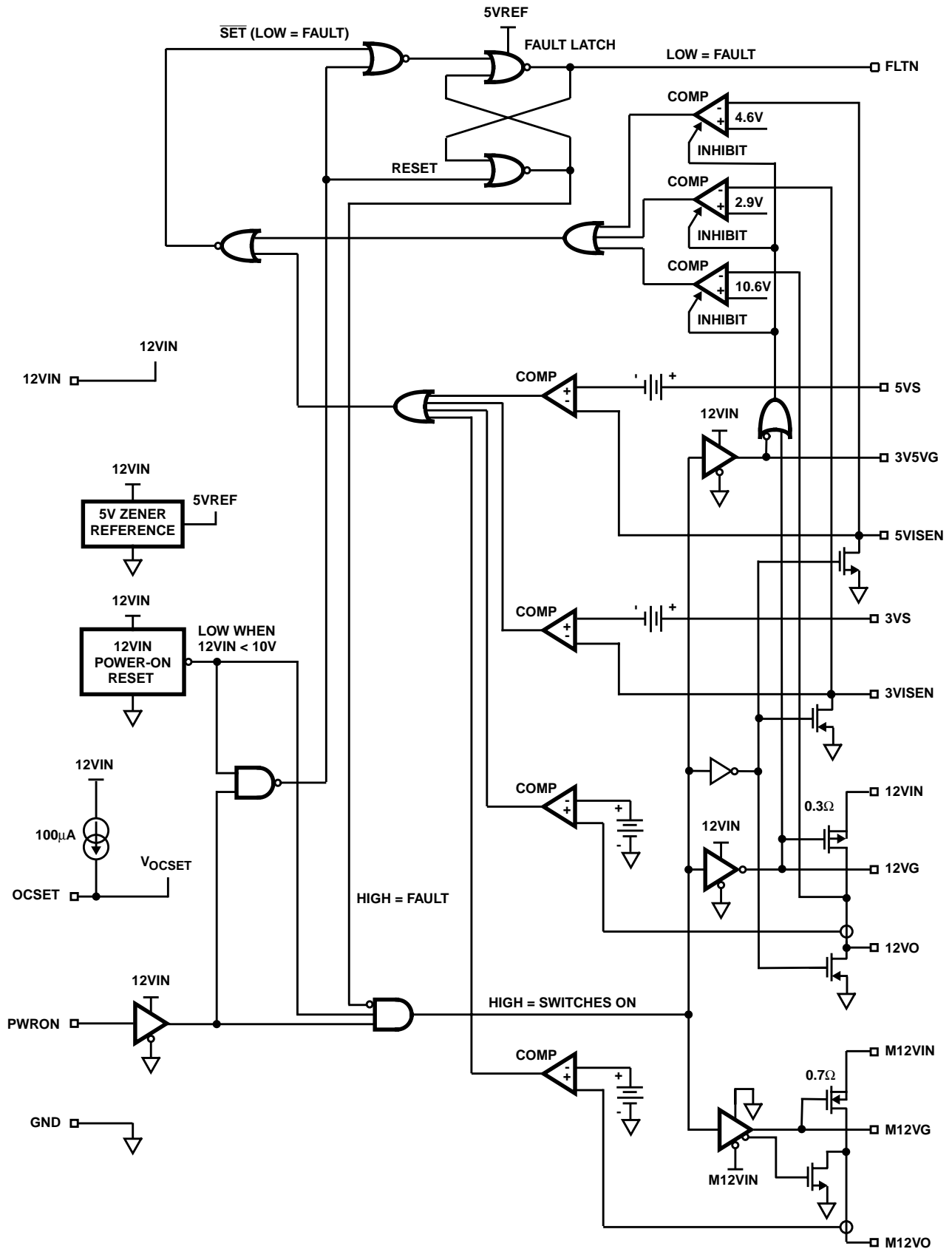

FIGURE 2.

**Pin Descriptions**

| PIN NO. | DESIGNATOR | FUNCTION              | DESCRIPTION   |
|---------|------------|-----------------------|---|
| 15, 28  | M12VIN     | -12V Input            | -12V Supply Input. Also provides power to the -12V overcurrent circuitry.   |
| 4, 11   | FLTN       | Fault Output          | 5V CMOS Fault Output; LOW = FAULT. An optional capacitor may be place from this pin to ground to provide additional immunity from power supply glitches.  |
| 20, 23  | 3V5VG      | 3.3V/5V Gate Output   | Drive the gates of the 3.3V and 5V MOSFETs. Connect a capacitor to ground to set the start-up ramp. During turn on, this capacitor is charged with a 25µA current source. UV comparator disabled when this pin below 9.6V nominal.  |
| 21, 22  | 12VIN      | 12V Input             | 12V supply input for IC and 12VO. Both 12VIns to be connected to a single +12V supply.  |
| 16, 27  | 3VISEN     | 3.3V Current Sense    | Connect to the load side of the current sense resistor in series with source of external 3.3V MOSFET.   |
| 17, 26  | 3VS        | 3.3V Source           | Connect to source of 3.3V MOSFET. This connection along with (3VISEN) senses the voltage drop across the sense resistor.  |
| 19, 24  | 5VS        | 5V Source             | Connect to source of 5V MOSFET switch. This connection along with (5VISEN) senses the voltage drop across the sense resistor.   |
| 18, 25  | 5VISEN     | 5V Current Sense      | Connect to the load side of the current sense resistor in series with source of external 5V MOSFET.   |
| 3, 12   | PWRON      | Power On Control      | Controls all four switches. High to turn switches ON, Low to turn them OFF.   |
| 6, 9    | 12VG       | Gate of Internal PMOS | Connect a capacitor between 12VG and 12VO to set the start-up ramp for the +12V supply. This capacitor is charged with a 25µA current source during start-up. UV comparator disabled when this pin >1.4Vnominal.  |
| 7, 8    | 12VO       | Switched 12V Output   | Switched 12V output. Rated for 0.5A.  |
| 2, 13   | M12VG      | Gate of Internal NMOS | Connect a capacitor between M12VG and M12VO to set the start-up ramp for the M12V supply. This capacitor is charged with 25µA during start-up.  |
| 1, 14   | M12VO      | Switched -12V Output  | Switched 12V Output. Rated for 100mA.   |
| 10      | OCSET      | Overcurrent Set       | Connect a resistor from this pin to ground to set the overcurrent trip point of all eight switches. All eight over current trips can be programmed by changing the value of this resistor. The default (6.04kΩ, 1%) is compatible with the maximum allowable currents as outlined in the PCI specification. |
| 5       | VSS        | Ground                | Connect to common of power supplies.  |

**Absolute Maximum Ratings**

|                        |                                       |
|------------------------|---------------------------------------|
| 12VIN                  | -0.5V to +14.0V                       |
| 12VO, 12VG, 3V5VG      | -0.5V to 12VIN +0.5V                  |
| M12VIN                 | -14.0V to +0.5V                       |
| M12VO, M12VG           | $V_{M12VIN} - 0.5V$ to +0.5V          |
| 3VISEN, 5VISEN         | -0.5V to the Lesser of 12VIN or +7.0V |
| Voltage, Any Other Pin | -0.5V to +7.0V                        |
| 12VO Output Current    | .3A                                   |
| M12VO Output Current   | 0.8A                                  |
| ESD Classification     | .2KeV (HBM)                           |

**Thermal Information**

|  |                                  |
|--|----------------------------------|
| Thermal Resistance (Typical, Note 1)     | $\theta_{JA}$ (°C/W)             |
| SSOP Package                             | 95                               |
| Maximum Junction Temperature             | 150°C                            |
| Maximum Storage Temperature Range        | -65°C to 150°C                   |
| Maximum Lead Temperature (Soldering 10s) | 300°C<br>(SSOP - Lead Tips Only) |

**Operating Conditions**

|                                     |                  |
|-------------------------------------|------------------|
| 12VIN Supply Voltage Range          | +10.8V to +13.2V |
| 5V and 3.3V Input Supply Tolerances | ±10%             |
| 12VO Output Current                 | 0 to +0.5A       |
| M12VO Output Current                | 0 to +0.1A       |
| Temperature Range (T <sub>A</sub> ) | 0°C to 70°C      |

CAUTION: Stresses above those listed in "Absolute Maximum Ratings" may cause permanent damage to the device. This is a stress only rating and operation of the device at these or any other conditions above those indicated in the operational sections of this specification is not implied.

NOTES:

1.  $\theta_{JA}$  is measured with the component mounted on an evaluation PC board in free air.
2. All voltages are relative to GND, unless otherwise specified.

**Electrical Specifications** Nominal 5.0V and 3.3V Input Supply Voltages,  
12VIN = 12V, M12VIN = -12V, T<sub>A</sub> = T<sub>J</sub> = 0 to 70°C, Unless Otherwise Specified

| PARAMETER  | SYMBOL                   | TEST CONDITIONS   | MIN  | TYP  | MAX | UNITS |
|--|--------------------------|---|------|------|-----|-------|
| <b>5V/3.3V SUPPLY CONTROL</b>                    |                          |   |      |      |     |       |
| 5V Overcurrent Threshold                         | I <sub>OC5V</sub>        | See Figure 24, Typical Application  | -    | 8    | -   | A     |
| 5V Overcurrent Threshold Voltage                 | V <sub>OC5V_1</sub>      | V <sub>OCSET</sub> = 0.6V   | 33   | 42   | 50  | mV    |
| 5V Overcurrent Threshold Voltage                 | V <sub>OC5V_2</sub>      | V <sub>OCSET</sub> = 1.2V   | 70   | 80   | 90  | mV    |
| 5V Undervoltage Trip Threshold                   | V <sub>5VUV</sub>        |   | 4.42 | 4.65 | 4.7 | V     |
| 5V Undervoltage Fault Response Time              | t <sub>5VUV</sub>        |   | -    | 110  | 160 | ns    |
| 5V Turn-On Time<br>(PWRON High to 5VOUT = 4.75V) | t <sub>ON5V</sub>        | C <sub>3V5VG</sub> = 0.022μF, C <sub>5VOUT</sub> = 2000μF, R <sub>L</sub> = 1Ω    | -    | 6.5  | -   | ms    |
| 3V Overcurrent Threshold                         | I <sub>OC3V</sub>        | See Figure 24, Typical Application  | -    | 10   | -   | A     |
| 3V Overcurrent Threshold Voltage                 | V <sub>OC3V_1</sub>      | V <sub>OCSET</sub> = 0.6V   | 41   | 52   | 62  | mV    |
| 3V Overcurrent Threshold Voltage                 | V <sub>OC3V_2</sub>      | V <sub>OCSET</sub> = 1.2V   | 89   | 98   | 108 | mV    |
| 3V Undervoltage Trip Threshold                   | V <sub>3VUV</sub>        |   | 2.74 | 2.86 | 2.9 | V     |
| 3V Undervoltage Fault Response Time              | t <sub>3VUV</sub>        |   | -    | 110  | 160 | ns    |
| 3V5VG Undervoltage Enable Threshold Voltage      | V <sub>3V5VGenVth</sub>  |   | -    | 9.6  | -   | V     |
| 3V Turn-On Time<br>(PWRON High to 3VOUT = 3.00V) | t <sub>ON3V</sub>        | C <sub>3V5VG</sub> = 0.022μF, C <sub>3VOUT</sub> = 2000μF, R <sub>L</sub> = 0.43Ω | -    | 6.5  | -   | ms    |
| 3V5VG Vout High                                  | V <sub>out_hi_35VG</sub> | PWRON = High, FLTN = High   | 11.5 | 11.8 | -   | V     |
| Gate Output Charge Current                       | I <sub>C3V5VG</sub>      | PWRON = High, V <sub>3V+5VG</sub> = 4V  | 19   | 25.0 | 29  | μA    |
| Gate Turn-On Time<br>(PWRON High to 3V5VG = 11V) | t <sub>ON3V5V</sub>      | C <sub>3V5VG</sub> = 0.033μF, 3V5VG Rising 10% to 90%                             | -    | 280  | -   | μs    |
| Gate Turn-Off Time                               | t <sub>OFF3V5V</sub>     | C <sub>3V5VG</sub> = 0.033μF, 3V5VG Falling 90% to 10%                            | -    | 2    | -   | μs    |

# HIP1011D

**Electrical Specifications** Nominal 5.0V and 3.3V Input Supply Voltages,  
12VIN = 12V, M12VIN = -12V,  $T_A = T_J = 0$  to  $70^\circ\text{C}$ , Unless Otherwise Specified **(Continued)**

| PARAMETER                                      | SYMBOL           | TEST CONDITIONS  | MIN   | TYP  | MAX  | UNITS         |
|--|------------------|--|-------|------|------|---------------|
| <b>+12V SUPPLY CONTROL</b>                     |                  |  |       |      |      |               |
| On Resistance of Internal PMOS                 | $r_{DS(ON)12}$   | PWRON = High, $I_D = 0.5\text{A}$ , $T_A = T_J = 25^\circ\text{C}$               | -     | 0.3  | 0.35 | $\Omega$      |
|  |                  | $T_A = T_J = 70^\circ\text{C}$   | -     | 0.35 | 0.50 | $\Omega$      |
| Overcurrent Threshold                          | $I_{OC12V\_1}$   | VOCSET = 0.6V  | 0.6   | 0.75 | 0.9  | A             |
| Overcurrent Threshold                          | $I_{OC12V\_2}$   | VOCSET = 1.2V  | 1.25  | 1.50 | 1.8  | A             |
| 12V Undervoltage Trip Threshold                | $V_{12VUV}$      |  | 10.25 | 10.6 | 10.8 | V             |
| Undervoltage Fault Response Time               | $t_{12VUV}$      |  | -     | 110  | -    | ns            |
| Gate Charge Current                            | $I_{C12VG}$      | PWRON = High, $V_{12VG} = 10\text{V}$  | 19    | 25.0 | 29   | $\mu\text{A}$ |
| Turn-On Time<br>(PWRON High to 12VG = 1V)      | $t_{ON12V}$      | $C_{12VG} = 0.033\mu\text{F}$ , 12VG Falling 90% - 10%                           | -     | 16   | -    | ms            |
| Turn-Off Time                                  | $t_{OFF12V}$     | $C_{12VG} = 0.022\mu\text{F}$ , 12VG Rising 10% - 90%                            | -     | 3    | -    | $\mu\text{s}$ |
| <b>-12V SUPPLY CONTROL</b>                     |                  |  |       |      |      |               |
| On Resistance of Internal NMOS                 | $r_{DS(ON)M12}$  | PWRON = High, $I_D = 0.1\text{A}$ , $T_A = T_J = 25^\circ\text{C}$               | -     | 0.7  | 1    | $\Omega$      |
|  |                  | $T_A = T_J = 70^\circ\text{C}$   | -     | 1.0  | 1.3  | $\Omega$      |
| Overcurrent Threshold                          | $I_{OC12V\_1}$   | VOCSET = 0.6V  | 0.13  | 0.18 | 0.25 | A             |
| Overcurrent Threshold                          | $I_{OC12V\_2}$   | VOCSET = 1.2V  | 0.23  | 0.38 | 0.52 | A             |
| Gate Output Charge Current                     | $I_{CM12VG}$     | PWRON = High, $V_{3VG} = -10\text{V}$  | 19    | 25   | 29   | $\mu\text{A}$ |
| Turn-On Time<br>(PWRON High to M12VO = -10.8V) | $t_{ONM12V}$     | $C_{M12VG} = 0.033\mu\text{F}$ , $C_{M12VO} = 50\mu\text{F}$ , $R_L = 120\Omega$ | -     | 16   | -    | ms            |
| Turn-Off Time                                  | $t_{OFFM12V}$    | $C_{M12VG} = 0.033\mu\text{F}$ , M12VG Falling 90% to 10%                        | -     | 3    | -    | $\mu\text{s}$ |
| M12VIN Input Bias Current                      | $I_{BM12VIN}$    | PWRON = High   | -     | 2.5  | 5    | mA            |
| <b>CONTROL I/O PINS</b>                        |                  |  |       |      |      |               |
| Supply Current                                 | $I_{VCC}$        |  |       | 5.3  | 8    | mA            |
| OCSET Current                                  | $I_{OCSET}$      |  | 93    | 100  | 107  | $\mu\text{A}$ |
| Overcurrent Fault Response Time                | $t_{OC}$         |  | -     | 500  | 960  | ns            |
| PWRON Threshold Voltage                        | $V_{THPWON}$     |  | 1.0   | 1.6  | 2.1  | V             |
| FLTN Output Low Voltage                        | $V_{FLTN,OL}$    | $I_{FLTN} = 2\text{mA}$  | -     | 0.5  | 0.7  | V             |
| FLTN Output High Voltage                       | $V_{FLTN,OH}$    | $I_{FLTN} = 0$ to $-4\text{mA}$  | 4.0   | 4.3  |      | V             |
| FLTN Output Latch Threshold                    | $V_{FLTN,TH}$    | FLTN High to Low transition  | 1.8   | 2.3  | 3    | V             |
| 12V Power On Enable Threshold                  | $V_{POR,THrise}$ | $V_{CC}$ Voltage Rising  | 9.4   | 10   | 10.2 | V             |
| 12V Power On Reset Threshold                   | $V_{POR,THfall}$ | $V_{CC}$ Voltage Falling   | 8.9   | 9.1  | 9.3  | V             |

## Introduction

The HIP1011D is the first device designed to provide control and protection of the four PCI power supplies independently to two PCI slots. Like the widely used HIP1011 this device complies with the PCI Hot Plug specification facilitating the service, upgrading or expansion of PCI based servers without the need to power down the server. The HIP1011D protects against over current (OC) for the -12V, +12V, +3.3V, +5V and under voltage (UV) conditions for the +12V, +3.3V, +5V supplies.

Figure 1 illustrates the typical implementation of the HIP1011D. Additional components for optimizing performance for particular applications, or desired features may be necessary.

## Key Feature Description and Operation

The HIP1011D, four power MOSFETs and a few passive components as configured in Figure 1, create a small yet complete power control solution for two PCI slots. It provides an OC trip level greater than the maximum PCI specified current for each supply to each slot. Over current monitoring and protection for the 3.3V and 5V supplies is provided by sensing the voltage across external current-sense resistors. For the +12V and -12V inputs, over current protection is provided internally. On-chip references are used to monitor the +5V, +3.3V and +12V outputs for under voltage conditions. During an over current condition on any output, or an under voltage condition on the +5V, +3.3V or +12V outputs, all slot specific MOSFETs are immediately latched-off and a LOW (0V) is presented to the appropriate FLTN output. During initial power-up of the main  $V_{CC}$  supply (+12V), the  $PWRON$  inputs are inhibited from turning on the switches, and the latch is held in the reset state until the  $V_{CC}$  input is greater than 10V. After a fault has been asserted and FLTN is latched low cycling  $PWRON$  low then high will clear the FLTN latch. User programming of the OC thresholds for both controlled slots is provided by a single resistor connected to the OCSET pin along with  $R_{sense}$ . In addition delay time to latch off after a fault condition can be increased by increasing the FLTN to ground capacitance and the turn-on ramp rate can be increased by increasing the gate pin capacitance.

## Customizing Circuit Performance

### Over Current (OC) Set Functionality and Resistor Choice

The HIP1011D allows easy custom programming of the over current (OC) levels of all 4 supplies simultaneously for both PCI slots by simply changing the resistor value between OCSET, (pin 10), and ground. The  $R_{OCSET}$  value and the OCSET 100 $\mu$ A current source sets a voltage that is used in each of eight comparators, (one for each supply for both slots). The voltages developed across the 3.3V and 5V sense resistors are applied to the inputs of their respective

comparators. The +12V and -12V currents are sensed internally with pilot devices. Once any comparator trips, that output is fed through logic circuits resulting in the appropriate FLTN, (pin 4 or pin 11), going low, indicating a fault condition on that particular slot. Because of the internal current monitoring of the +12V and -12V switches, their programming flexibility is limited to  $R_{OCSET}$  changes. The 3.3V and 5V over current trip points depend on both  $R_{OCSET}$  and the value chosen for each sense resistor.

Over current design guidelines and recommendations are as follows:

1. For PCI applications, set  $R_{OCSET}$  to 6.04k $\Omega$ , and use 5m $\Omega$  1% sense resistors (see Figure 24).
2. For non PCI specified applications, the following precautions and limitations apply:
  - A. **Do not** exceed the maximum power of the integrated NMOS and PMOS. High power dissipation must be coupled with effective thermal management. The integrated PMOS has an  $r_{DS(ON)}$  of 0.3 $\Omega$ . Thus, with 1A of steady load current on each of the PMOS devices the power dissipation is 0.6W. The thermal impedance of the package is 95 degrees Celsius per watt, limiting the average DC current on the 12V supply to about 1A on each slot and imposing an upper limit on the  $R_{OCSET}$  resistor. **Do not** use an  $R_{OCSET}$  resistor greater than 15k $\Omega$ .  
The average current on the -12V supply should not exceed 0.7A. Since the thermal restrictions on the +12V supply are more severe, the +12V supply restricts the use of the HIP1011 to applications where the  $\pm$ 12V supplies draw relatively little current. Since both supplies only have one degree of freedom, the value of  $R_{OCSET}$ , the flexibility of programming is quite limited. For applications where more power is required on the +12V supply, contact your local Intersil sales representative for information on other Hot Plug solutions.
  - B. **Do not** try to sense voltages across the external sense resistors that are less than 33mV. Spurious faults due to noise and comparator input sensitivity may result. The minimum recommended  $R_{OCSET}$  value is 6k $\Omega$ . This will set the nominal OC voltage thresholds at 52mV and 42mV for the 3.3V and 5V comparators respectively. This is the voltage level at which the OC fault ( $I_{OUT} \times R_{SENSE}$ ) will occur.
  - C. Minimize  $V_{RSENSE}$  so as to not significantly reduce the voltage delivered to the adapter card. Remember PCB trace and connector distribution voltage losses also need to be considered. Make sure that the  $R_{SENSE}$  resistor can adequately handle the dissipated power. For best results use a 1% precision resistor with a low temperature coefficient.
  - D. Minimize external FET  $r_{DS(ON)}$ . Low  $r_{DS(ON)}$  or multiple MOSFETs in parallel are recommended. See Intersil for a complete selection of MOSFET offerings.

TABLE 1.

| SUPPLY         | HOW TO DETERMINE NOMINAL ( $\pm 10\%$ ) $I_{OC}$ FOR EACH SUPPLY |
|----------------|--|
| +3.3V $I_{OC}$ | $((100\mu A \times R_{OCSET})/11.5)/R_{RSENSE}$                  |
| +5.0V $I_{OC}$ | $((100\mu A \times R_{OCSET})/14.5)/R_{RSENSE}$                  |
| +12V $I_{OC}$  | $(100\mu A \times R_{OCSET})/0.8$                                |
| -12V $I_{OC}$  | $(100\mu A \times R_{OCSET})/3.3$                                |

### Time Delay to Latch-Off

Time delay to latch-off allows for a predetermined delay from an OC or UV event to the simultaneous latch-off of all four supply switches of the affected slot by the HIP1011D. This delay period is set by the capacitance value to ground from the FLTN pins for each slot. This capacitance value tailors the FLTN signal going low ramp rate. This provides a delay to the fault signal latch-off threshold voltage, FLTN,  $V_{th}$ . By increasing this time, the HIP1011D delays immediate latch-off of the bus supply switches, thus ignoring transient OC and UV conditions. See additional information in the "Using the HIP1011DEVAL1 Platform" section of this data sheet.

**Caution:** The primary purpose of a protection device such as the HIP1011D is to quickly isolate a faulted card from the voltage bus. Delaying the time to latch-off works against this primary concern so care must be taken when using this feature. Ensure adequate sizing of external FETs to carry additional current during time out period. Understand that voltage bus disruptions must be minimized for the time delay period in the event of a crow bar failure.

Devices using an unadjustable preset delay to latch-off time present the user with the inability to eliminate these concerns increasing cost and the chance of additional ripple through failures.

### HIP1011D Soft Start and Turn-Off Considerations

The HIP1011D does allow the user to select the rate of ramp up on the voltage supplies. This start-up ramp minimizes in-rush current at start-up while the on card bulk capacitors charge. The ramp is created by placing capacitors on M12VG to M12VO, 12VG to 12VO and 3V5VG to ground. These capacitors are each charged up by a nominal  $25\mu A$  current during turn on. The same value for all gate timing capacitors is recommended. A recommended minimum value of  $0.033\mu F$  as a smaller value may cause overcurrent faults at power up. This recommendation results in a nominal gate voltage ramp rate of  $0.76V/ms$ . The gate capacitors must be discharged when a fault is detected to turn off the power FETs. Thus, larger caps slow the response time. If the gate capacitors are too large the HIP1011D may not be able to adequately protect the bus or the power FETs. The HIP1011D has internal discharge FETs to discharge the load when disabled. Upon turn-off these internal switches on each output discharge the load capacitance pulling the output to gnd. These switches are also on when PWRON is low thus an open slot is held at the gnd level.

### Decoupling Precautions and Recommendations

For the HIP1011D proper decoupling is a particular concern during the normal switching operation and especially during a card crowbar failure. If a card experiences a crow bar short to ground, the supply to the other card will experience transients until the faulted card is isolated from the bus. In addition the common IC nodes between the two sides can fluctuate unpredictably resulting in a false latch-off of the second slot. Additionally to the mother board bulk capacitance, it is recommended that  $10\mu F$  capacitors be placed on both the +12V and -12V lines of the HIP1011D as close to the chip as possible.

### Recommended PCB Layout Design Best Practices

To ensure accurate current sensing, PCB traces that connect each of the current sense resistors to the HIP1011D **must not** carry any load current. This can be accomplished by two dedicated PCB kelvin traces directly from the sense resistors to the HIP1011D, see examples of correct and incorrect layouts below in Figure 3. To reduce parasitic inductance and resistance effects, maximize the width of the high-current PCB traces.

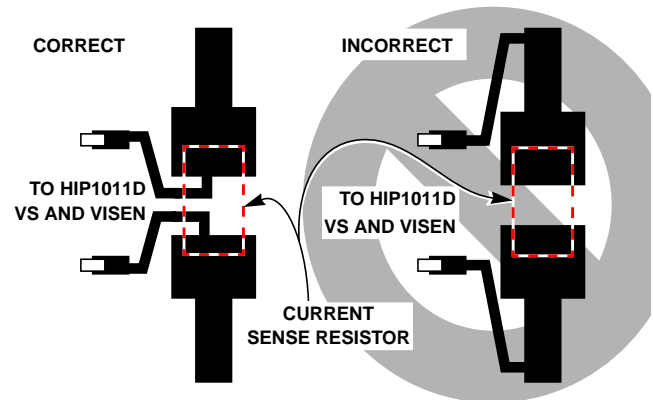

FIGURE 3. SENSE RESISTOR PCB LAYOUT



Typical Performance Curves

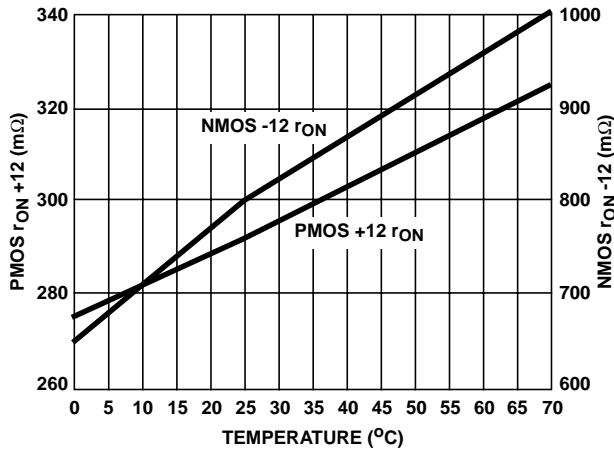

FIGURE 4.  $r_{ON}$  vs TEMPERATURE

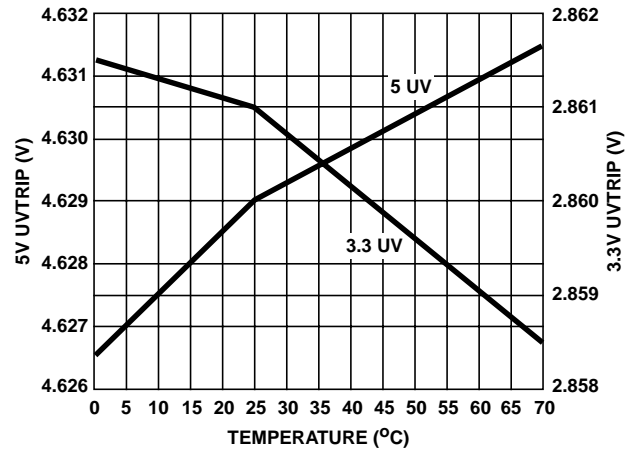

FIGURE 5. UV TRIP vs TEMPERATURE

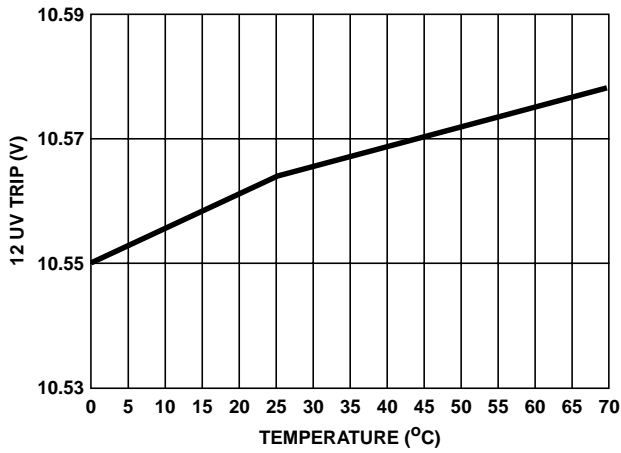

FIGURE 6. 12 UV TRIP vs TEMPERATURE

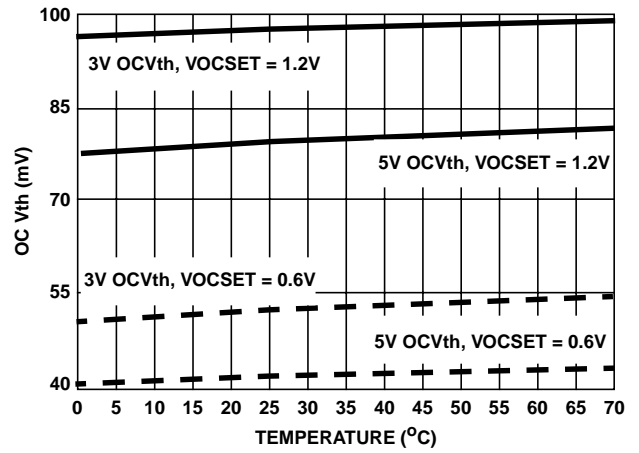

FIGURE 7. OC Vth vs TEMPERATURE

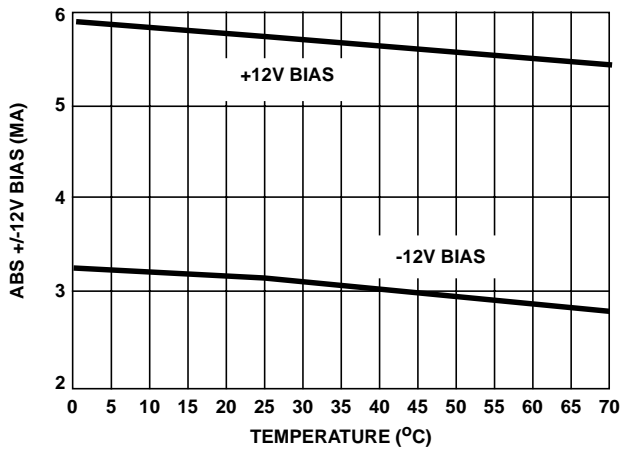

FIGURE 8. BIAS CURRENT vs TEMPERATURE

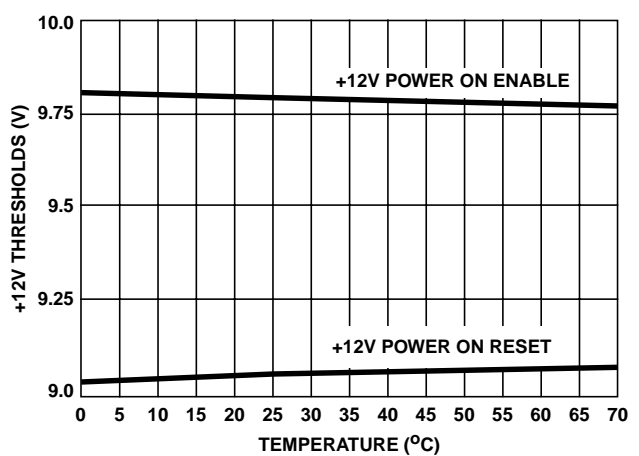

FIGURE 9. 12V ENABLE AND RESET THRESHOLD VOLTAGES vs TEMPERATURE

Typical Performance Curves (Continued)

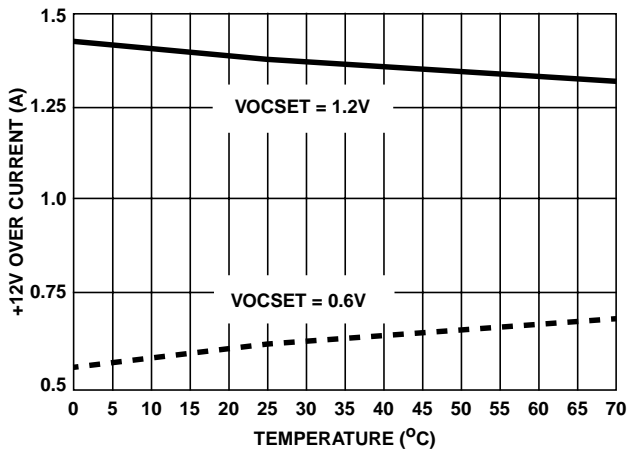

FIGURE 10. +12V OVER CURRENT LEVEL vs TEMPERATURE

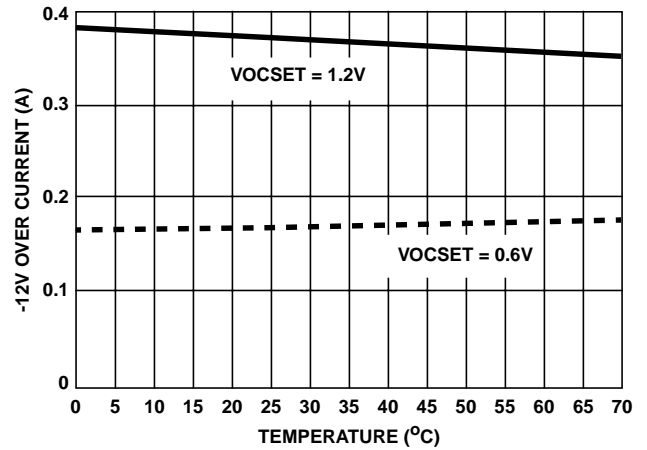

FIGURE 11. -12V OVER CURRENT vs TEMPERATURE

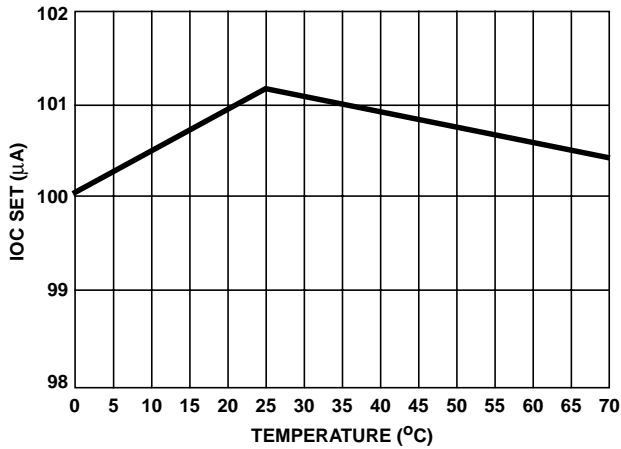

FIGURE 12. OCSET CURRENT vs TEMPERATURE

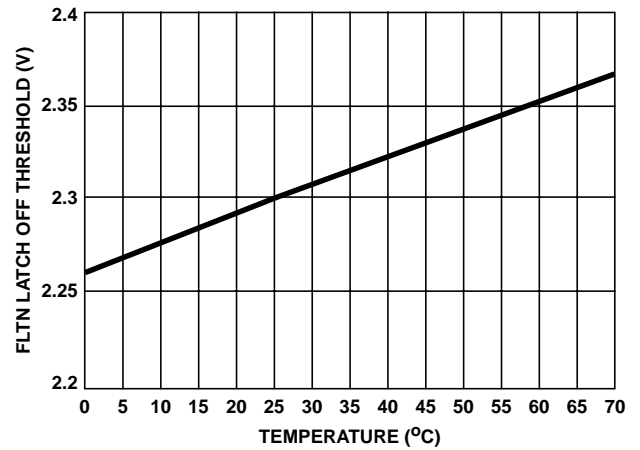

FIGURE 13. FLT N LATCH OFF THRESHOLD VOLTAGE vs TEMPERATURE

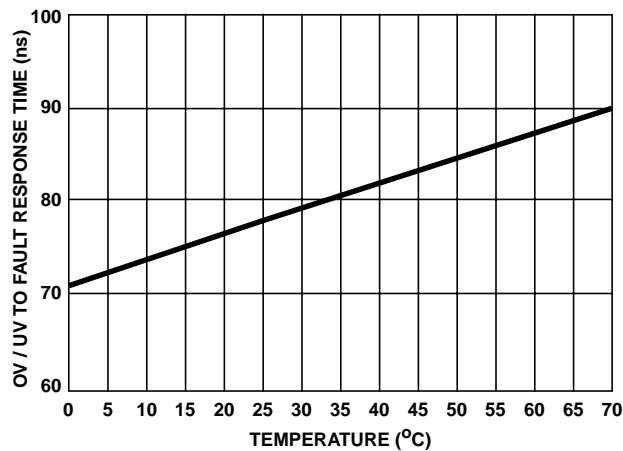

FIGURE 14. OVER CURRENT AND UNDERVOLTAGE TO FLT N RESPONSE TIME vs TEMPERATURE

## Using the HIP1011DEVAL1 Platform

### General and Biasing Information

The HIP1011DEVAL1 platform (Figure 24) comes as a three part set consisting of 1 mother board emulator and 2 load cards. This evaluation platform allows a designer to evaluate and modify the performance and functionality of the HIP1011D in a simple environment.

Test point numbers (TP#) correspond to the HIP1011D device (U5) pin numbers thus TP3 and TP12 are PWRON\_2 and PWRON\_1 respectively. These 2 pins are the HIP1011D control inputs for each of the 2 integrated but independent PCI power controllers in the HIP1011D.

On the HIP1011DEVAL1 platform are 4 HUF76132SK8, (11.5mΩ, 30V, 11.5A) N-Channel power MOSFETs, (Q1-Q4) these are used as the external switches for the +5V and +3.3V supplies to the load card connectors, P1 and P2.

Current sensing is facilitated by the four 5mΩ 1W metal strip resistors (R1-R4), the voltages developed across the sense resistors are compared to references on board the HIP1011D.

The HIP1011DEVAL1 platform is powered through the J1 to J5 connector jacks near the top of the board, see Table 2 for bias voltage assignments.

TABLE 2. HIP1011DEVAL1 BIAS ASSIGNMENTS

| J1  | J2  | J3   | J4   | J5    |
|-----|-----|------|------|-------|
| GND | +5V | -12V | +12V | +3.3V |

After properly biasing the HIP1011D and ensuring there is an adequate ground return from the HIP1011DEVAL1 platform to the power supplies, (otherwise anomalous and unpredictable results will occur) signal the PWRON inputs low then insert the load cards as shown in Figure 15. Signaling either or both PWRON pins high (>2.4V) will turn on the appropriate FET switches and apply voltage to the load cards.

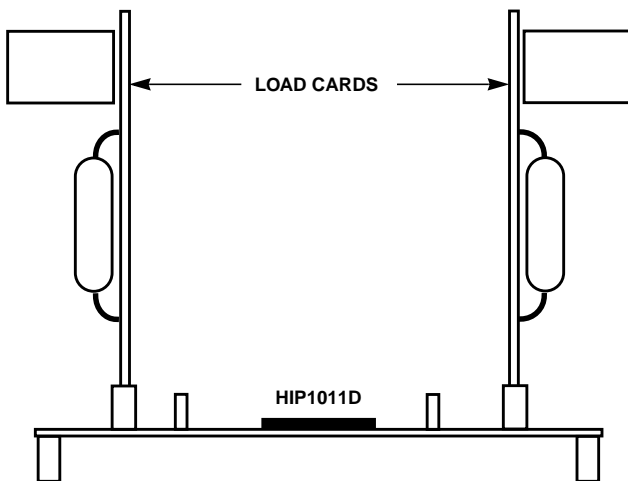

FIGURE 15. CORRECT INSTALLATION OF LOAD CARDS

### Evaluating Time Delay to Latch-Off

Provided for delay to latch-off evaluation are 2 locations for 1206 SMD capacitors, C7 and C8. Filling these locations places a capacitor to ground from each of the HIP1011D FLTN pins thus tailoring the FLTN signal going low ramp rate. This provides a delay to the fault signal latch-off threshold voltage, FLTN V<sub>th</sub>. By increasing this time the HIP1011D delays immediate latch-off of the bus supply switches, thus ignoring transient OC and UV conditions. See Table 3 illustrating the time it takes for switch gate turn-off from the FLTN start of response to an OC or UV condition. The FLTN response to an OC or UV condition is 110ns. See Figures 20 through 23 for waveforms.

The intent of any protection device is to isolate the supply quickly so a faulty card does not drag down a supply. A longer latch-off delay results in less isolation from a faulty card to supply.

TABLE 3.

| C7 AND C8 VALUE       | OPEN  | 0.001μF | 0.01μF | 0.1μF |
|-----------------------|-------|---------|--------|-------|
| FLTN to Gate Response | 0.1μs | 0.44μs  | 2.9μs  | 28μs  |

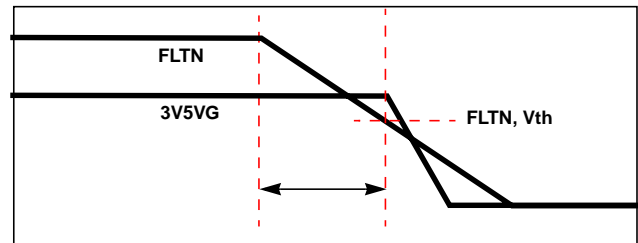

FIGURE 16. TIMING DIAGRAM

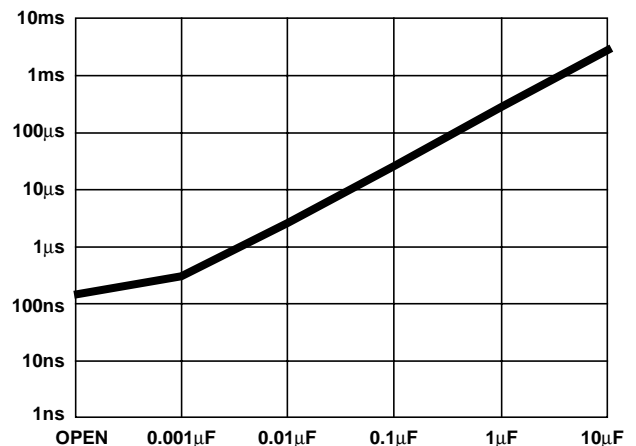
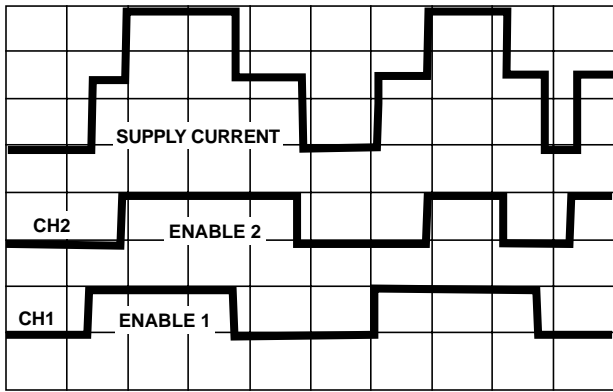

FIGURE 17. TYPICAL OC/UV TO VG RESPONSE vs FLTN CAP

Typical Performance Curves (Continued)



CH1 AND CH2 VOLTAGE (5V/DIV)  
CH3 CURRENT (2A/DIV)  
TIME (100ms/DIV)

FIGURE 18. HIP1011DEVAL1 3.3V SUPPLY CURRENT AS EACH SLOT CONTROLLER TURNS ON INTO LOAD CARD

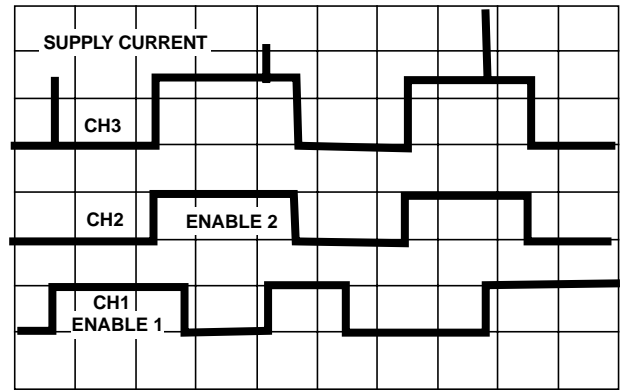

CH1 AND CH2 VOLTAGE (5V / DIV)  
CH3 CURRENT (2A/DIV)  
TIME (100ms/DIV)

FIGURE 19. HIP1011DEVAL1 3.3V SUPPLY CURRENT AS CONTROLLER 1 TURNS ON INTO SHORTED LOAD CARD

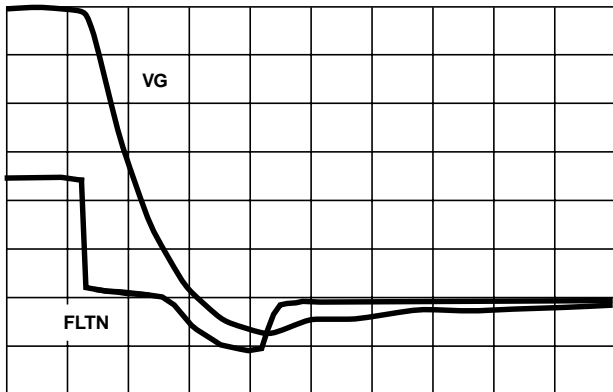

VOLTAGE (2V/DIV)  
TIME (1μs / DIV)  
FLTN = OPEN

FIGURE 20. FLTN TO 35VG DELAY

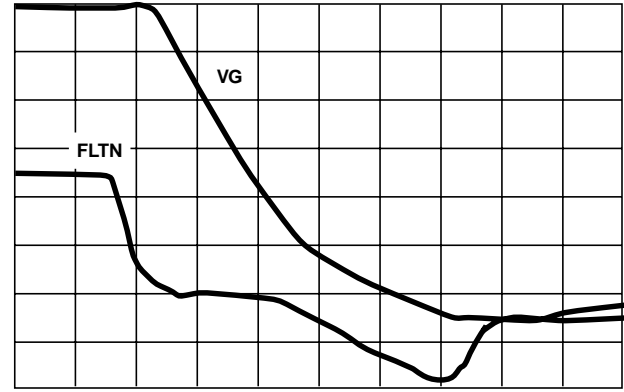

VOLTAGE (2V/DIV)  
TIME (1μs / DIV)  
FLTN = 0.001μF

FIGURE 21. FLTN TO 35VG DELAY

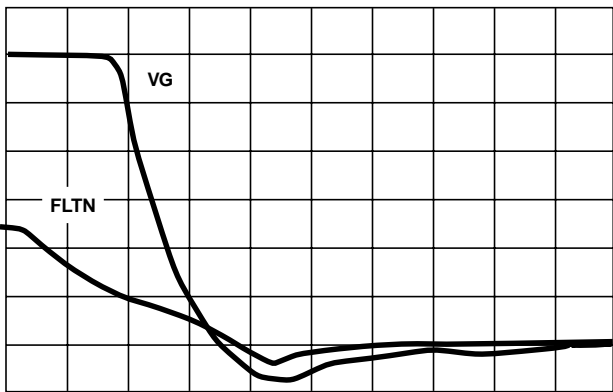

VOLTAGE (2V/DIV)  
TIME (2μs/DIV)  
FLTN = 0.01μF

FIGURE 22. FLTN TO 35VG DELAY

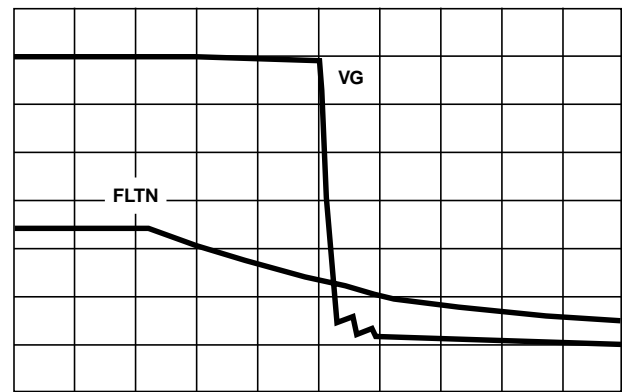

VOLTAGE (2V/DIV)  
TIME (10μs/DIV)  
FLTN = 0.1μF

FIGURE 23. FLTN TO 35VG DELAY

# HIP1011D

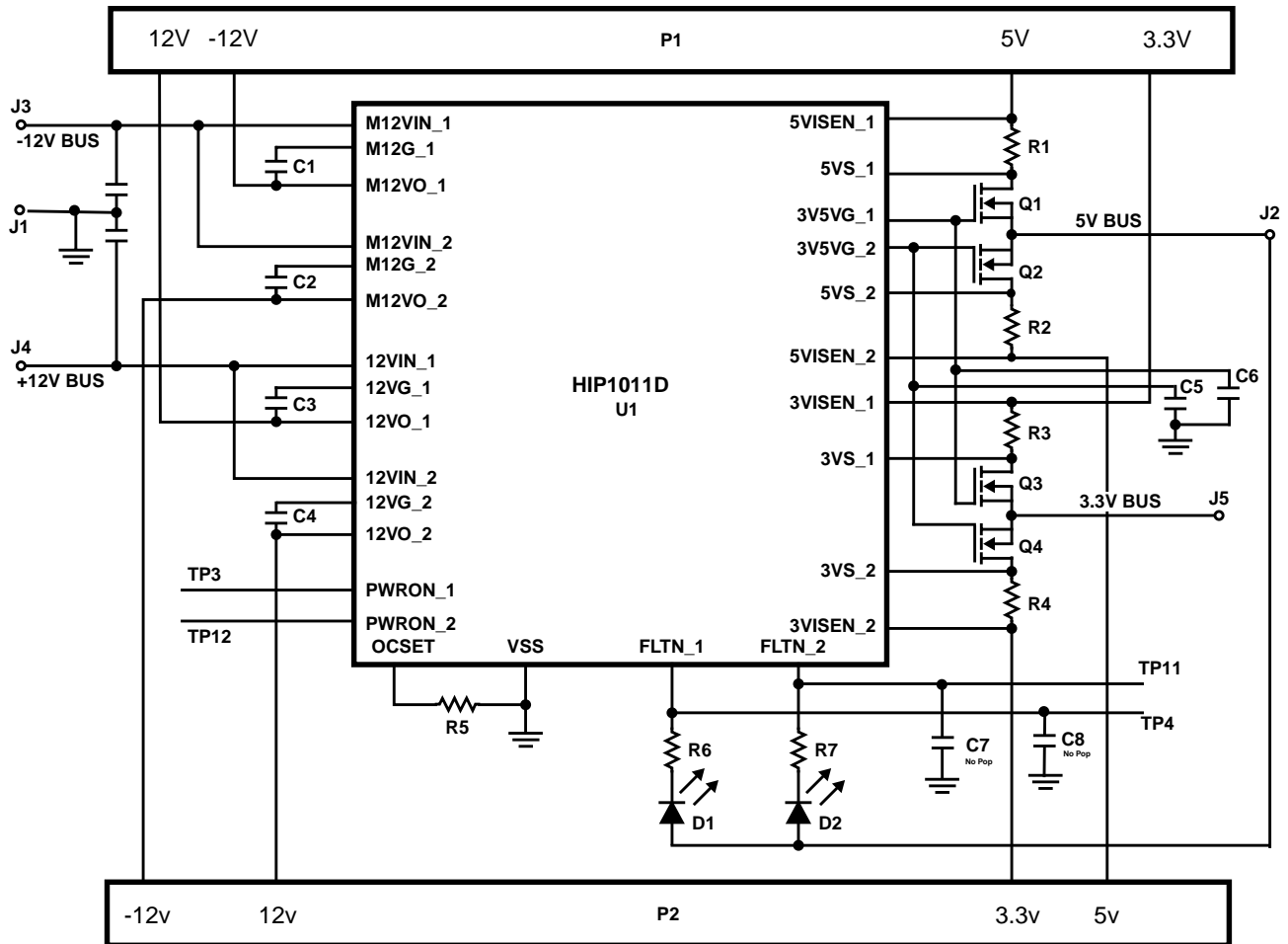

FIGURE 24.

TABLE 4. HIP1011DEVAL1 BOARD COMPONENT LISTING

| COMPONENT DESIGNATOR  | COMPONENT NAME                                 | COMPONENT DESCRIPTION  |
|-----------------------|--|--|
| U1                    | HIP1011DCB PCI HotPlug Controller              | Intersil, HIP1011DCB Dual PCI HotPlug Controller                       |
| Q1, Q2, Q3, Q4        | HUF76132SK8                                    | Intersil, HUF76132SK8, 11.5mΩ, 30V, 11.5A Logic Level N-Channel MOSFET |
| R1 - R4               | Sense Resistor for 3.3V and 5V Supplies        | Dale, WSL-2512 5mΩ Metal Strip Resistor                                |
| C1 - C6               | Gate Timing Capacitors                         | 0.033μF 805 Chip Capacitor   |
| R5                    | Over Current Set Resistor                      | 6kΩ 805 Chip Resistor  |
| C7, C8 (Not Provided) | Latch-Off Delay Capacitors                     | Place provided for 805 Chip Cap  |
| R6, R7                | LED Series Resistors                           | 470Ω 805 Chip Resistors  |
| D1, D2                | Fault Indicating LED                           | Green SMD LED  |
| TP1 - TP28            | Test Point for Corresponding Device Pin Number |  |
| P1, P2                | Connectors for Load Cards                      | Sullins EZM06DRXH  |
| RL1                   | 3.3V Load Board Resistor                       | 1.1Ω, 10W  |
| RL2                   | 5.0V Load Board Resistor                       | 2.5Ω, 10W  |
| RL3                   | +12V Load Board Resistor                       | 47Ω, 5W  |
| RL4                   | -12V Load Board Resistor                       | 240Ω, 2W   |
| CL1, CL2              | +3.3V and +5.0V Load Board Capacitors          | 2200μF   |
| CL3, CL4              | +12V and -12V Load Board Capacitors            | 100μF  |

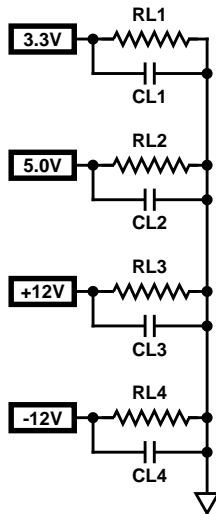
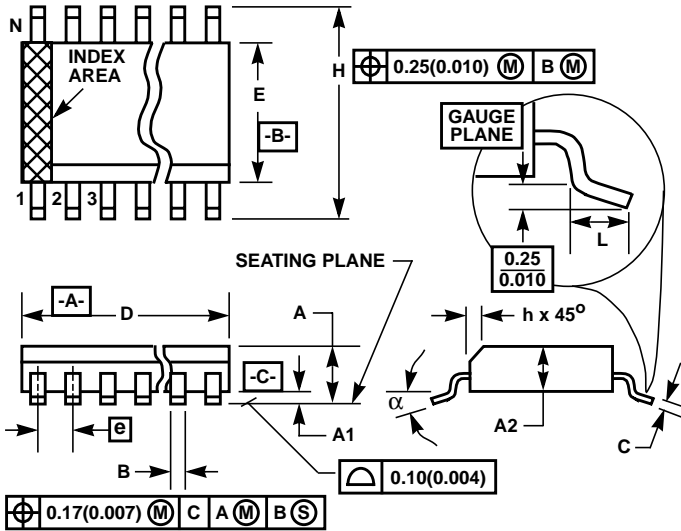

FIGURE 25. LOAD BOARD (2x)

Shrink Small Outline Plastic Packages (SSOP)



**M28.15**  
28 LEAD SHRINK NARROW BODY SMALL OUTLINE PLASTIC PACKAGE

| SYMBOL | INCHES    |        | MILLIMETERS |       | NOTES |
|--------|-----------|--------|-------------|-------|-------|
|        | MIN       | MAX    | MIN         | MAX   |       |
| A      | 0.053     | 0.069  | 1.35        | 1.75  | -     |
| A1     | 0.004     | 0.010  | 0.10        | 0.25  | -     |
| A2     | -         | 0.061  | -           | 1.54  | -     |
| B      | 0.008     | 0.012  | 0.20        | 0.30  | 9     |
| C      | 0.007     | 0.010  | 0.18        | 0.25  | -     |
| D      | 0.386     | 0.394  | 9.81        | 10.00 | 3     |
| E      | 0.150     | 0.157  | 3.81        | 3.98  | 4     |
| e      | 0.025 BSC |        | 0.635 BSC   |       | -     |
| H      | 0.228     | 0.244  | 5.80        | 6.19  | -     |
| h      | 0.0099    | 0.0196 | 0.26        | 0.49  | 5     |
| L      | 0.016     | 0.050  | 0.41        | 1.27  | 6     |
| N      | 28        |        | 28          |       | 7     |
| α      | 0°        | 8°     | 0°          | 8°    | -     |

Rev. 0 2/95

NOTES:

1. Symbols are defined in the "MO Series Symbol List" in Section 2.2 of Publication Number 95.
2. Dimensioning and tolerancing per ANSI Y14.5M-1982.
3. Dimension "D" does not include mold flash, protrusions or gate burrs. Mold flash, protrusion and gate burrs shall not exceed 0.15mm (0.006 inch) per side.
4. Dimension "E" does not include interlead flash or protrusions. Interlead flash and protrusions shall not exceed 0.25mm (0.010 inch) per side.
5. The chamfer on the body is optional. If it is not present, a visual index feature must be located within the crosshatched area.
6. "L" is the length of terminal for soldering to a substrate.
7. "N" is the number of terminal positions.
8. Terminal numbers are shown for reference only.
9. Dimension "B" does not include dambar protrusion. Allowable dambar protrusion shall be 0.10mm (0.004 inch) total in excess of "B" dimension at maximum material condition.
10. Controlling dimension: INCHES. Converted millimeter dimensions are not necessarily exact.

All Intersil semiconductor products are manufactured, assembled and tested under **ISO9000** quality systems certification.

*Intersil semiconductor products are sold by description only. Intersil Corporation reserves the right to make changes in circuit design and/or specifications at any time without notice. Accordingly, the reader is cautioned to verify that data sheets are current before placing orders. Information furnished by Intersil is believed to be accurate and reliable. However, no responsibility is assumed by Intersil or its subsidiaries for its use; nor for any infringements of patents or other rights of third parties which may result from its use. No license is granted by implication or otherwise under any patent or patent rights of Intersil or its subsidiaries.*

For information regarding Intersil Corporation and its products, see web site [www.intersil.com](http://www.intersil.com)

**Sales Office Headquarters**

**NORTH AMERICA**

Intersil Corporation  
P. O. Box 883, Mail Stop 53-204  
Melbourne, FL 32902  
TEL: (321) 724-7000  
FAX: (321) 724-7240

**EUROPE**

Intersil SA  
Mercure Center  
100, Rue de la Fusee  
1130 Brussels, Belgium  
TEL: (32) 2.724.2111  
FAX: (32) 2.724.22.05

**ASIA**

Intersil (Taiwan) Ltd.  
7F-6, No. 101 Fu Hsing North Road  
Taipei, Taiwan  
Republic of China  
TEL: (886) 2 2716 9310  
FAX: (886) 2 2715 3029