

SCHOTTKY RECTIFIER

3 Amp

Major Ratings and Characteristics

Characteristics	30BQ100	Units
$I_{F(AV)}$ Rectangular waveform	3.0	A
V_{RRM}	100	V
I_{FSM} @ $t_p = 5\mu s$ sine	2100	A
V_F @ 3.0Apk, $T_J = 125^\circ C$	0.62	V
T_J	-55 to 175	$^\circ C$

Description / Features

The 30BQ100 surface-mount Schottky rectifier has been designed for applications requiring very low forward drop and small foot prints on PC boards. Typical applications are in disk drives, switching power supplies, converters, free-wheeling diodes, battery charging and reverse battery protection.

- Small footprint, surface mountable
- Very low forward voltage drop
- High frequency operation
- Guard ring for enhanced ruggedness and long-term reliability

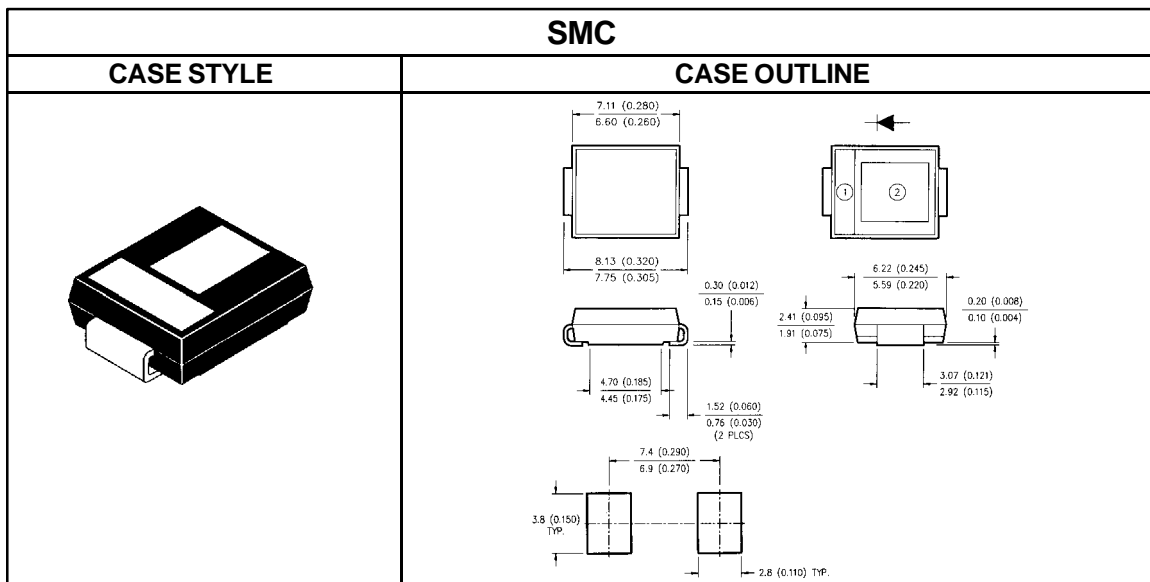

30BQ100



Voltage Ratings

Part number	30BQ100
V_R Max. DC Reverse Voltage (V)	100
V_{RWM} Max. Working Peak Reverse Voltage (V)	

Absolute Maximum Ratings

Parameters		30BQ	Units	Conditions
$I_{F(AV)}$	Max. Average Forward Current See Fig. 5	3.0	A	50% duty cycle @ $T_C = 143^\circ\text{C}$, rectangular waveform
		4.0		50% duty cycle @ $T_C = 132^\circ\text{C}$, rectangular waveform
I_{FSM}	Max. Peak One Cycle Non - Repetitive Surge Current — see Fig. 7	2100	A	5 μs Sine or 3 μs Rect. pulse
		100		10ms Sine or 6ms Rect. pulse
E_{AS}	Non - Repetitive Avalanche Energy	50	mJ	$T_J = 25^\circ\text{C}$, $I_{AS} = 2.8\text{A}$, $L = 10\text{mH}$ Following any rated load condition and with rated V_{RWM} applied.
I_{AR}	Repetitive Avalanche Current	2.8	A	Current decaying linearly to zero in 1 μsec Frequency limited by T_J max. $V_A = 1.5 \times V_R$ typical

Electrical Specifications

Parameters		30BQ	Units	Conditions
V_{FM}	Max. Forward Voltage Drop See Fig. 1 ①	0.79	V	@ 3.0A
		0.90	V	@ 6.0A
		0.62	V	@ 3.0A
		0.70	V	@ 6.0A
I_{RM}	Max. Reverse Leakage Current ① See Fig. 2	0.50	mA	$T_J = 25^\circ\text{C}$
		5.0	mA	$T_J = 125^\circ\text{C}$
C_T	Max. Junction Capacitance	115	pF	$V_R = 5V_{DC}$, (test signal range 100kHz to 1MHz) 25°C
L_S	Typical Series Inductance	3.0	nH	Measured lead to lead 5mm from package body
dv/dt	Max. Voltage Rate of Change (Rated V_R)	10,000	V/ μs	

Thermal-Mechanical Specifications

Parameters		30BQ	Units	Conditions
T_J	Max. Junction Temperature Range	-55 to 100	$^\circ\text{C}$	
T_{STG}	Max. Storage Temperature Range	-55 to 100	$^\circ\text{C}$	
R_{thJA}	Max. Thermal Resistance, Junction to Ambient	12	$^\circ\text{C}/\text{W}$	DC operation — See Fig. 4
R_{thJL}	Max. Thermal Resistance, Junction to Lead ②	46	$^\circ\text{C}/\text{W}$	DC operation
wt	Approximate Weight	0.24	g	
Case Style		SMC		Similar to DO-214AB

① Pulse Width < 300 μs , Duty Cycle < 2%

② Mounted 1 inch square PCB, thermal probe connected to lead 2mm from package

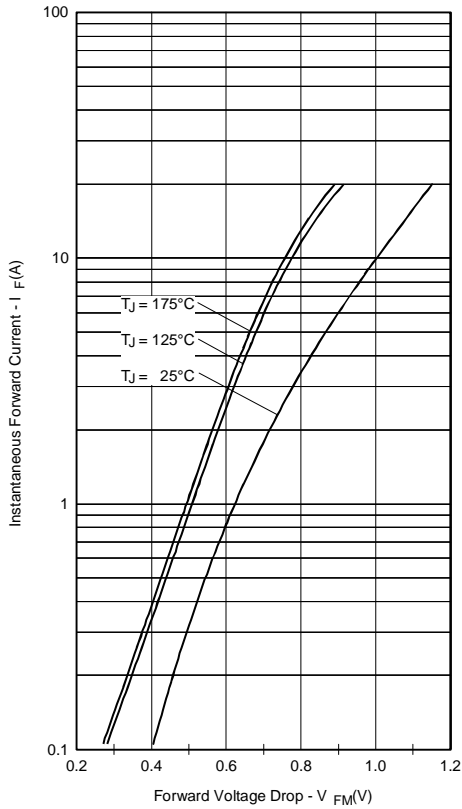

Fig. 1 Max. Forward Voltage Drop Characteristics

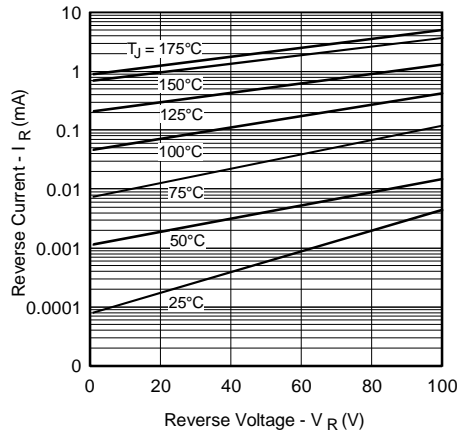

Fig. 2 Typical Values of Reverse Current Vs. Reverse Voltage

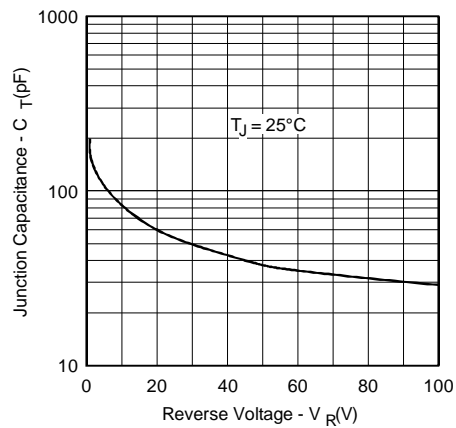

Fig. 3 Typical Junction Capacitance Vs. Reverse Voltage

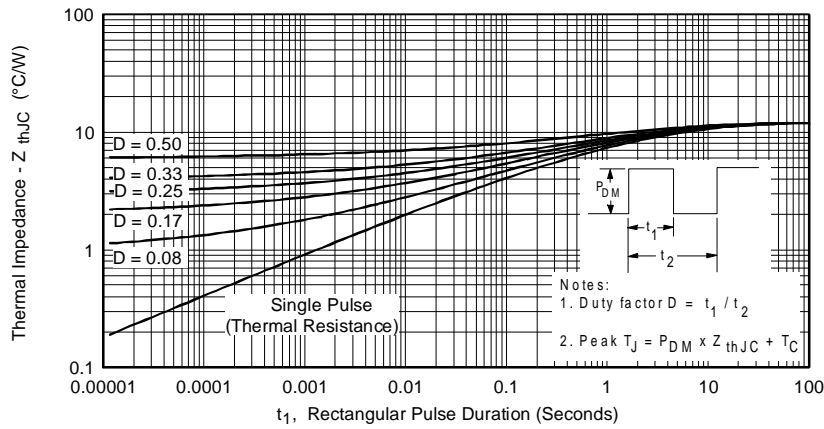

Fig. 4 Max. Thermal Impedance Z_{thJL} Characteristics

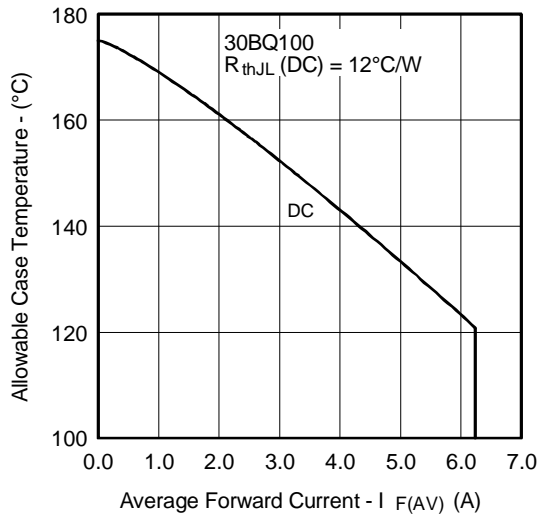

Fig. 5 Max. Allowable Case Temperature Vs. Average Forward Current

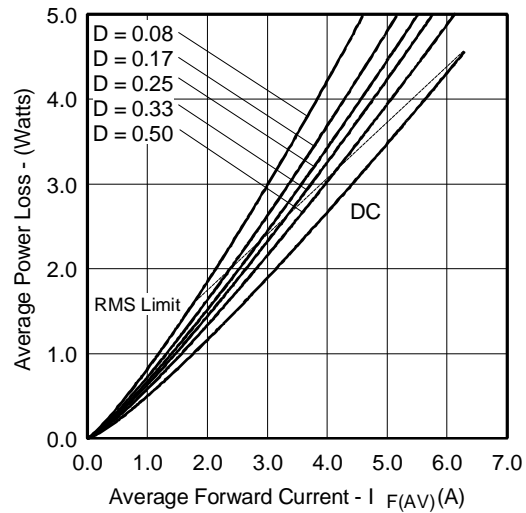

Fig. 6 Forward Power Loss Characteristics

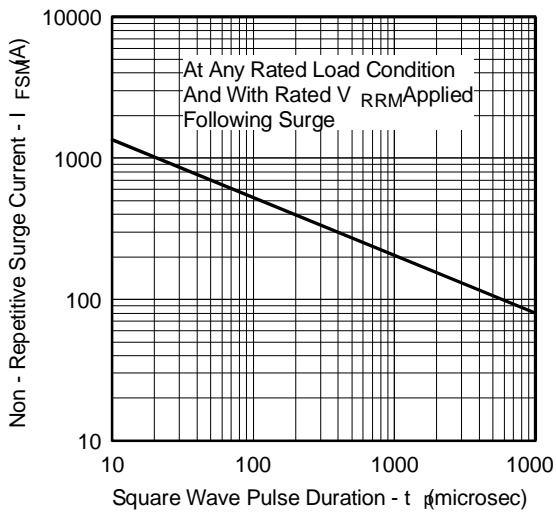

Fig. 7 Max. Non-Repetitive Surge Current

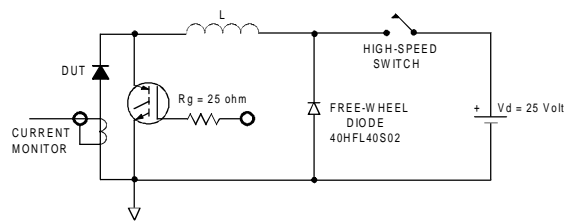

Fig. 8 Unclamped Inductive Test Circuit

Refer to the Appendix Section for the following:

Appendix D: Tape and Reel Information — See page 339.