

---

***DISCRETE POWER DIODES and THYRISTORS***  
***DATA BOOK***

---

### INVERTER GRADE THYRISTORS

### Hockey Puk Version

#### Features

- Metal case with ceramic insulator
- International standard case TO-200AB (E-PUK)
- All diffused design
- Center amplifying gate
- Guaranteed high  $dV/dt$
- Guaranteed high  $dI/dt$
- High surge current capability
- Low thermal impedance
- High speed performance

#### Typical Applications

- Inverters
- Choppers
- Induction heating
- All types of force-commutated converters

720A



case style TO-200AB (E-PUK)

#### Major Ratings and Characteristics

Parameters	ST333C..C	Units	
$I_{T(AV)}$	720	A	
@ $T_{hs}$	55	°C	
$I_{T(RMS)}$	1435	A	
@ $T_{hs}$	25	°C	
$I_{TSM}$	@ 50Hz	11000	A
	@ 60Hz	11500	A
$I^2t$	@ 50Hz	605	KA <sup>2</sup> s
	@ 60Hz	553	KA <sup>2</sup> s
$V_{DRM}/V_{RRM}$	400 to 800	V	
$t_q$ range	10 to 30	μs	
$T_J$	- 40 to 125	°C	

# ST333C..C Series

## ELECTRICAL SPECIFICATIONS

### Voltage Ratings

Type number	Voltage Code	$V_{DRM}/V_{RRM}$ , maximum repetitive peak voltage V	$V_{RSM}$ , maximum non-repetitive peak voltage V	$I_{DRM}/I_{RRM}$ max. @ $T_J = T_J$ max. mA
ST333C..C	04	400	500	50
	08	800	900	

### Current Carrying Capability

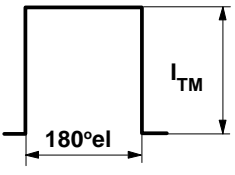
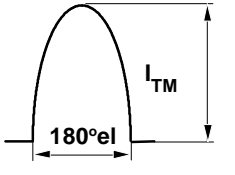
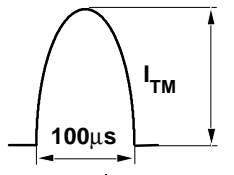
Frequency				Units			
50Hz	1630	1420	2520	2260	7610	6820	A
400Hz	1630	1390	2670	2330	4080	3600	
1000Hz	1350	1090	2440	2120	2420	2100	
2500Hz	720	550	1450	1220	1230	1027	
Recovery voltage Vr	50	50	50	50	50	50	V
Voltage before turn-on Vd	$V_{DRM}$		$V_{DRM}$		$V_{DRM}$		
Rise of on-state current di/dt	50	50	-	-	-	-	A/µs
Heatsink temperature	40	55	40	55	40	55	°C
Equivalent values for RC circuit	10Ω / 0.47µF		10Ω / 0.47µF		10Ω / 0.47µF		

### On-state Conduction

Parameter	ST333C..C	Units	Conditions		
$I_{T(AV)}$ Max. average on-state current @ Heatsink temperature	720 (350)	A	180° conduction, half sine wave double side (single side) cooled		
	55 (75)	°C			
$I_{T(RMS)}$ Max. RMS on-state current	1435	A	DC @ 25°C heatsink temperature double side cooled		
$I_{TSM}$ Max. peak, one half cycle, non-repetitive surge current	11000		t = 10ms	No voltage reappplied	
	11500		t = 8.3ms	reappplied	
	9250		t = 10ms	100% $V_{RRM}$ reappplied	
	9700	t = 8.3ms	reappplied		
$I^2t$ Maximum $I^2t$ for fusing	605	KA <sup>2</sup> s	t = 10ms	No voltage reappplied	Sinusoidal half wave, Initial $T_J = T_J$ max
	553		t = 8.3ms	reappplied	
	428		t = 10ms	100% $V_{RRM}$ reappplied	
	391		t = 8.3ms	reappplied	
$I^2\sqrt{t}$ Maximum $I^2\sqrt{t}$ for fusing	6050	KA <sup>2</sup> √s	t = 0.1 to 10ms, no voltage reappplied		

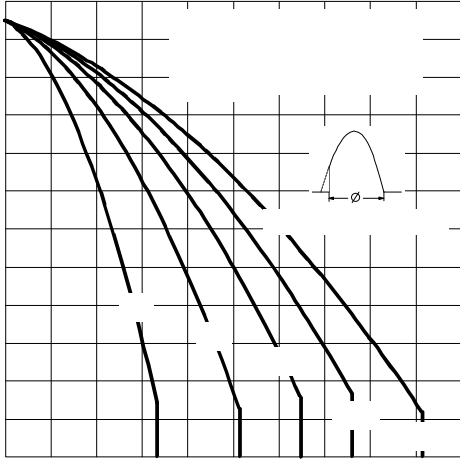

Fig. 3 - Current Ratings Characteristics

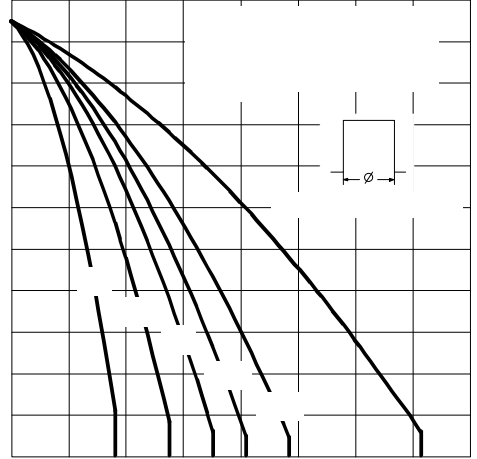

Fig. 4 - Current Ratings Characteristics

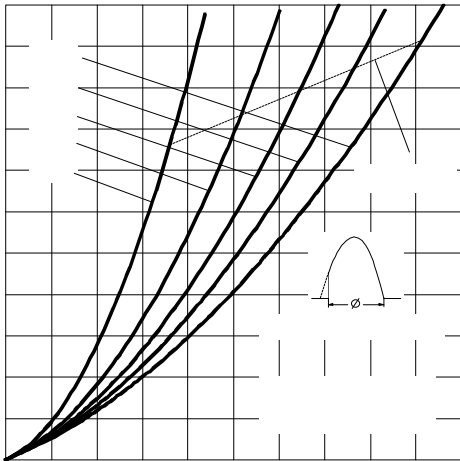

Fig. 5 - On-state Power Loss Characteristics

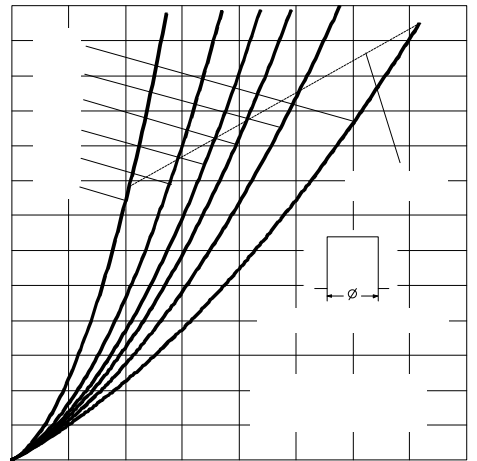

Fig. 6 - On-state Power Loss Characteristics

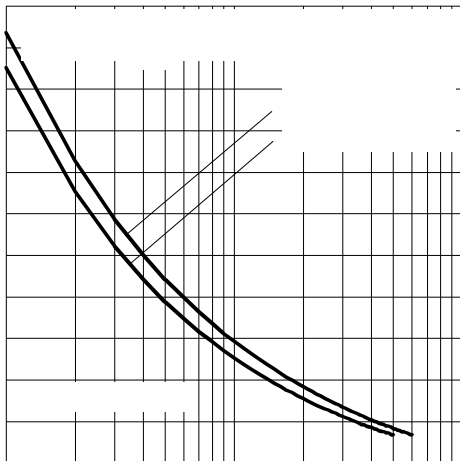

Fig. 7 - Maximum Non-repetitive Surge Current

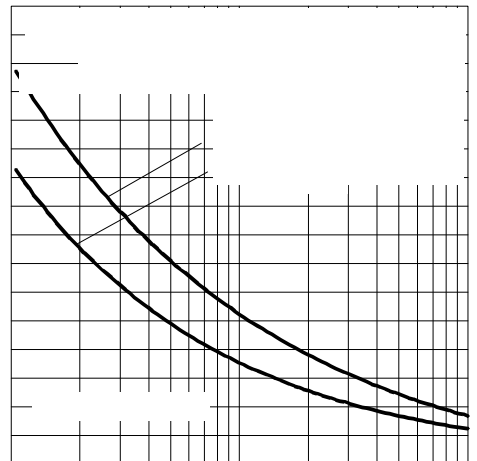

Fig. 8 - Maximum Non-repetitive Surge Current

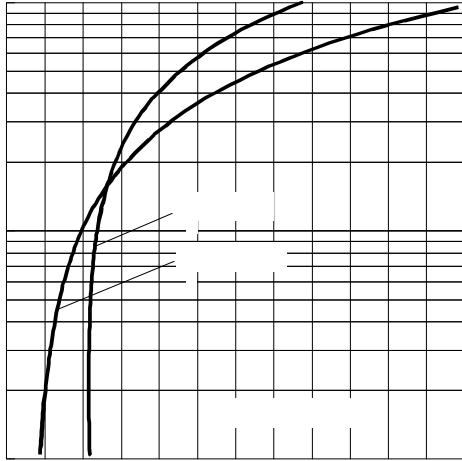

Fig. 9 - On-state Voltage Drop Characteristics

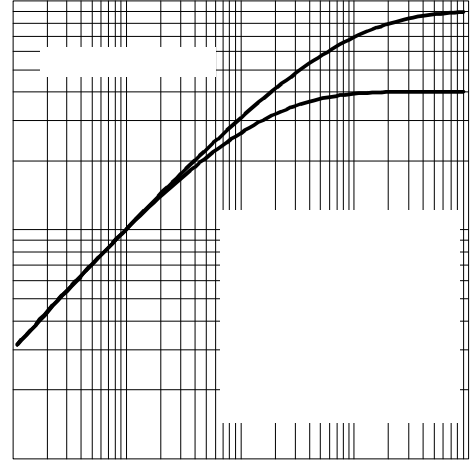

Fig. 10 - Thermal Impedance  $Z_{thJ-hs}$  Characteristics

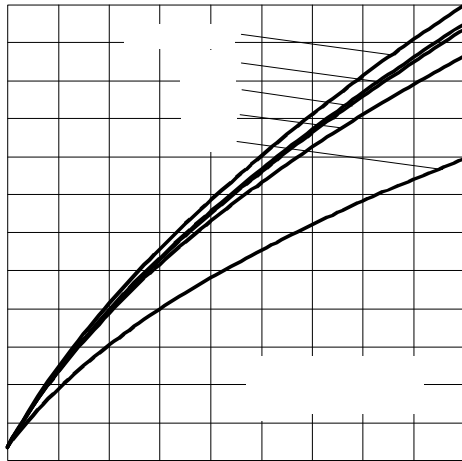

Fig. 11 - Reverse Recovered Charge Characteristics

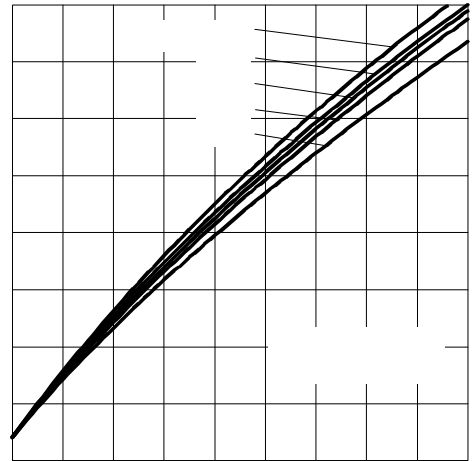

Fig. 12 - Reverse Recovery Current Characteristics

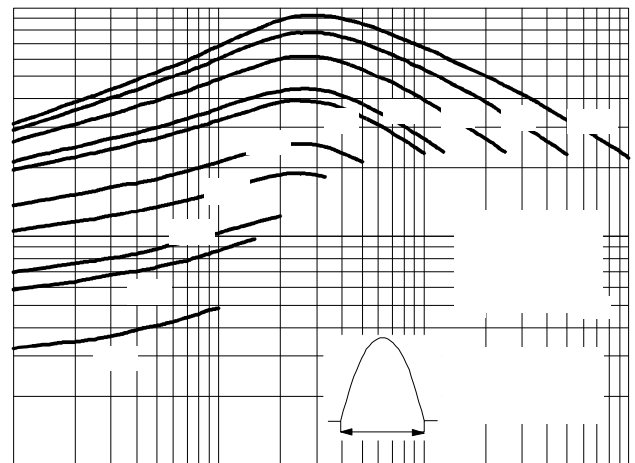
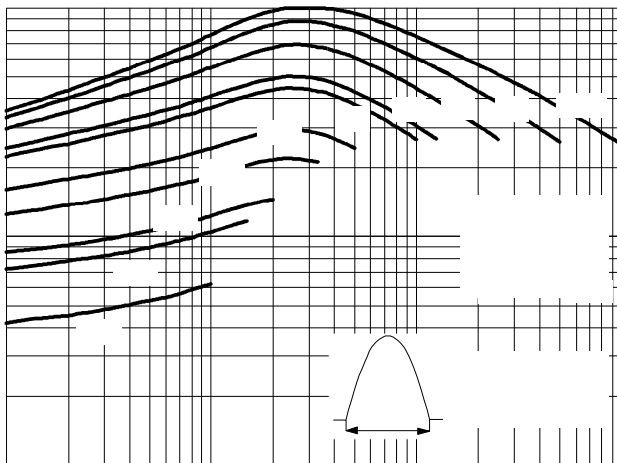

Fig. 13 - Frequency Characteristics

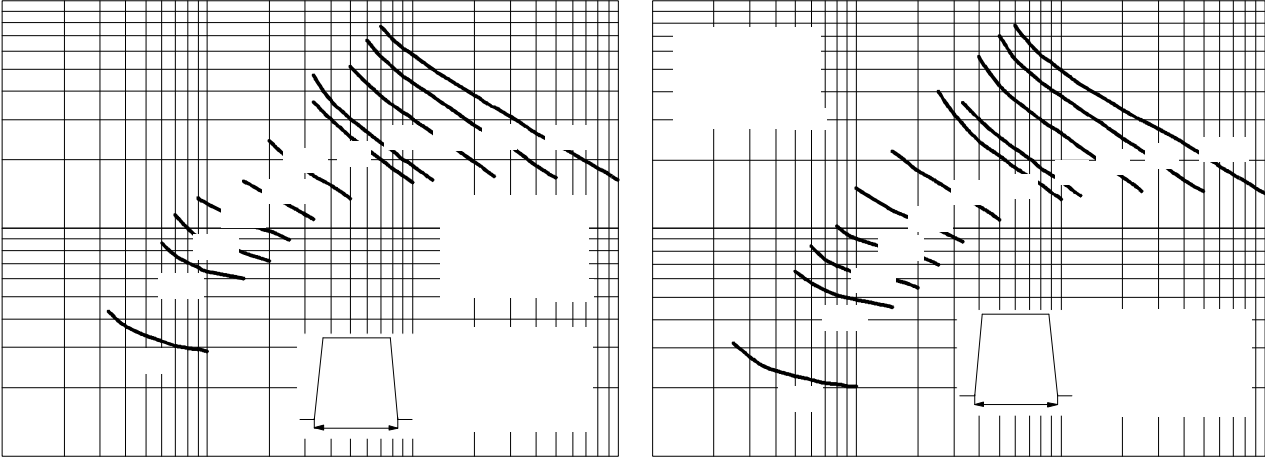

Fig. 14 - Frequency Characteristics

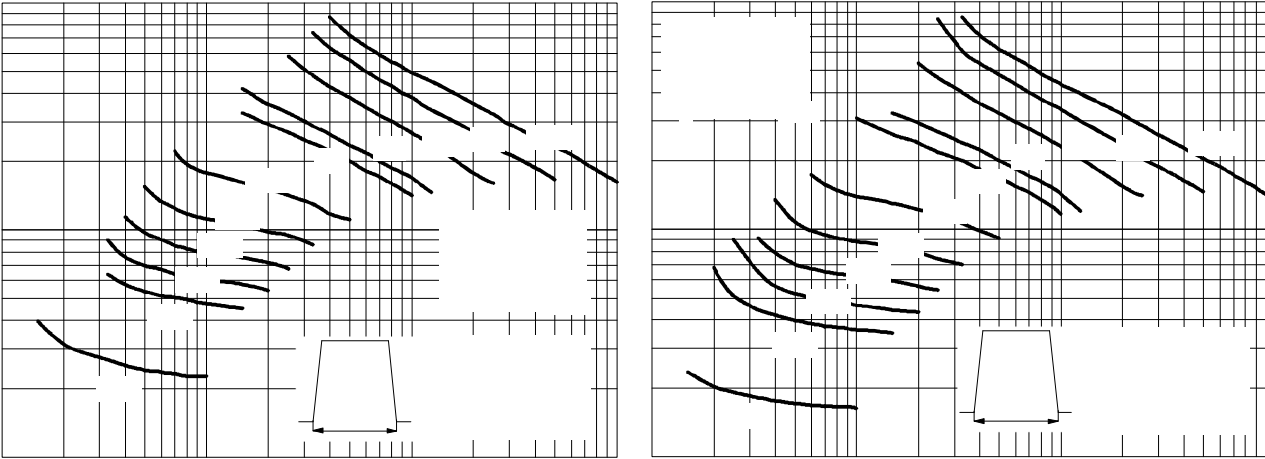

Fig. 15 - Frequency Characteristics

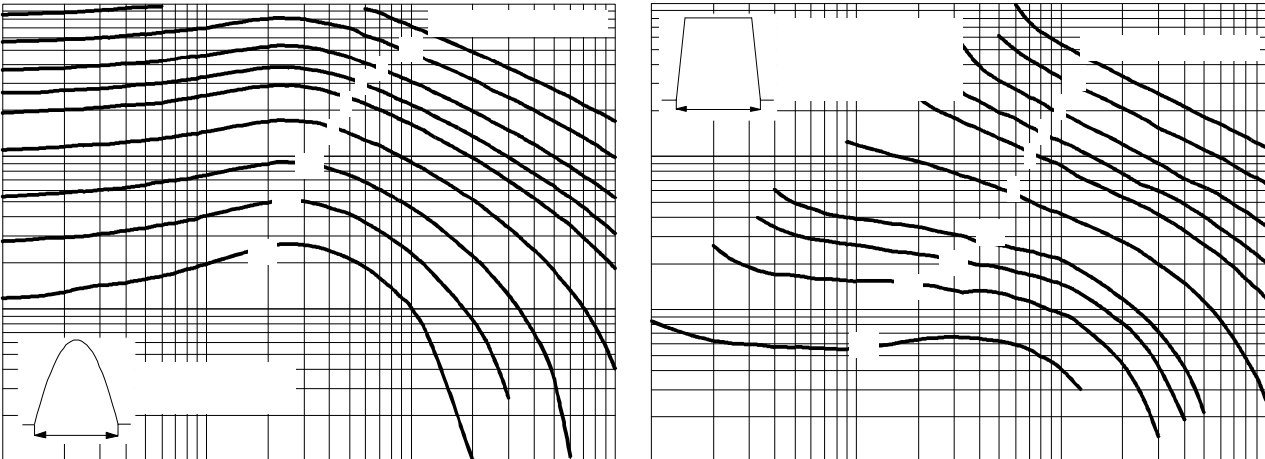

Fig. 16 - Maximum On-state Energy Power Loss Characteristics

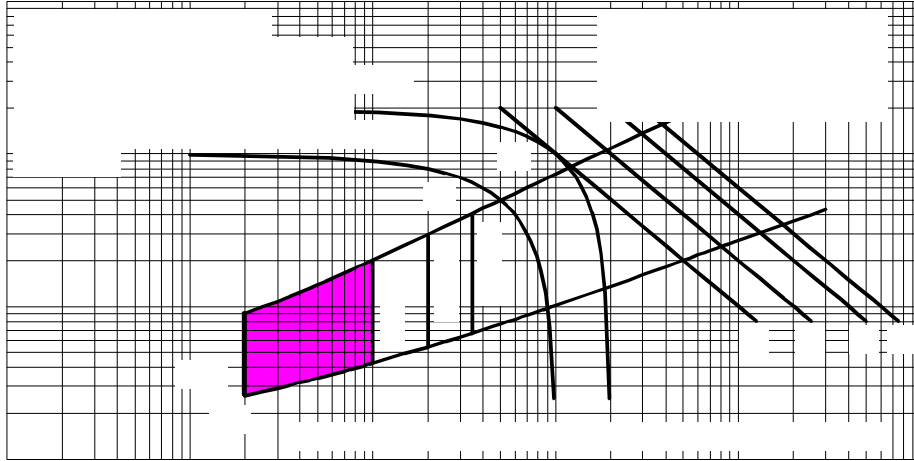

Fig. 17 - Gate Characteristics

## On-state Conduction

Parameter	ST333C..C	Units	Conditions
$V_{TM}$ Max. peak on-state voltage	1.96	V	$I_{TM} = 1810A$ , $T_J = T_J \text{ max}$ , $t_p = 10\text{ms}$ sine wave pulse
$V_{T(TO)1}$ Low level value of threshold voltage	0.91		$(16.7\% \times \pi \times I_{T(AV)} < I < \pi \times I_{T(AV)})$ , $T_J = T_J \text{ max}$ .
$V_{T(TO)2}$ High level value of threshold voltage	0.93		$(I > \pi \times I_{T(AV)})$ , $T_J = T_J \text{ max}$ .
$r_{t1}$ Low level value of forward slope resistance	0.58	m $\Omega$	$(16.7\% \times \pi \times I_{T(AV)} < I < \pi \times I_{T(AV)})$ , $T_J = T_J \text{ max}$ .
$r_{t2}$ High level value of forward slope resistance	0.58		$(I > \pi \times I_{T(AV)})$ , $T_J = T_J \text{ max}$ .
$I_H$ Maximum holding current	600	mA	$T_J = 25^\circ\text{C}$ , $I_T > 30A$
$I_L$ Typical latching current	1000		$T_J = 25^\circ\text{C}$ , $V_A = 12V$ , $R_a = 6\Omega$ , $I_G = 1A$

## Switching

Parameter	ST333C..C	Units	Conditions
di/dt Max. non-repetitive rate of rise of turned-on current	1000	A/ $\mu\text{s}$	$T_J = T_J \text{ max}$ , $V_{DRM} = \text{rated } V_{DRM}$ $I_{TM} = 2 \times \text{di/dt}$
$t_d$ Typical delay time	1.1	$\mu\text{s}$	$T_J = 25^\circ\text{C}$ , $V_{DM} = \text{rated } V_{DRM}$ , $I_{TM} = 50A$ DC, $t_p = 1\mu\text{s}$ Resistive load, Gate pulse: 10V, 5 $\Omega$ source
$t_q$ Max. turn-off time	Min 10 Max 30		$T_J = T_J \text{ max}$ , $I_{TM} = 550A$ , commutating di/dt = 40A/ $\mu\text{s}$ $V_R = 50V$ , $t_p = 500\mu\text{s}$ , dv/dt: see table in device code

## Blocking

Parameter	ST333C..C	Units	Conditions
dv/dt Maximum critical rate of rise of off-state voltage	500	V/ $\mu\text{s}$	$T_J = T_J \text{ max}$ . linear to 80% $V_{DRM}$ , higher value available on request
$I_{RRM}$ $I_{DRM}$ Max. peak reverse and off-state leakage current	50	mA	$T_J = T_J \text{ max}$ , rated $V_{DRM}/V_{RRM}$ applied

## Triggering

Parameter	ST333C..C	Units	Conditions
$P_{GM}$ Maximum peak gate power	60	W	$T_J = T_J \text{ max}$ ., $f = 50\text{Hz}$ , $d\% = 50$
$P_{G(AV)}$ Maximum average gate power	10		
$I_{GM}$ Max. peak positive gate current	10	A	$T_J = T_J \text{ max}$ , $t_p \leq 5\text{ms}$
$+V_{GM}$ Maximum peak positive gate voltage	20	V	$T_J = T_J \text{ max}$ , $t_p \leq 5\text{ms}$
$-V_{GM}$ Maximum peak negative gate voltage	5		
$I_{GT}$ Max. DC gate current required to trigger	200	mA	$T_J = 25^\circ\text{C}$ , $V_A = 12V$ , $R_a = 6\Omega$
$V_{GT}$ Max. DC gate voltage required to trigger	3	V	
$I_{GD}$ Max. DC gate current not to trigger	20	mA	$T_J = T_J \text{ max}$ , rated $V_{DRM}$ applied
$V_{GD}$ Max. DC gate voltage not to trigger	0.25	V	



# ST333C..C Series

## Thermal and Mechanical Specification

Parameter	ST333C..C	Units	Conditions
T <sub>J</sub> Max. operating temperature range	-40 to 125	°C	
T <sub>stg</sub> Max. storage temperature range	-40 to 150		
R <sub>thJ-hs</sub> Max. thermal resistance, junction to heatsink	0.09 0.04	K/W	DC operation single side cooled DC operation double side cooled
R <sub>thC-hs</sub> Max. thermal resistance, case to heatsink	0.020 0.010		K/W
F Mounting force, ± 10%	9800 (1000)	N (Kg)	
wt Approximate weight	83	g	
Case style	TO - 200AB (E-PUK)		See Outline Table

## ΔR<sub>thJ-hs</sub> Conduction

(The following table shows the increment of thermal resistance R<sub>thJ-hs</sub> when devices operate at different conduction angles than DC)

Conduction angle	Sinusoidal conduction		Rectangular conduction		Units	Conditions
	Single Side	Double Side	Single Side	Double Side		
180°	0.010	0.011	0.007	0.007	K/W	T <sub>J</sub> = T <sub>J</sub> max.
120°	0.012	0.012	0.012	0.013		
90°	0.015	0.015	0.016	0.017		
60°	0.022	0.022	0.023	0.023		
30°	0.036	0.036	0.036	0.036		

## Ordering Information Table

**Device Code**

ST	33	3	C	08	C	H	K	1	
①	②	③	④	⑤	⑥	⑦	⑧	⑨	⑩

- 1** - Thyristor
- 2** - Essential part number
- 3** - 3 = Fast turn off
- 4** - C = Ceramic Puk
- 5** - Voltage code: Code x 100 = V<sub>RRM</sub> (See Voltage Rating Table)
- 6** - C = Puk Case TO-200AB (E-PUK)
- 7** - Reapplied dv/dt code (for t<sub>q</sub> test condition)
- 8** - t<sub>q</sub> code
- 9** - 0 = Eyelet term. (Gate and Aux. Cathode Unsoldered Leads)  
 1 = Fast-on term. (Gate and Aux. Cathode Unsoldered Leads)  
 2 = Eyelet term. (Gate and Aux. Cathode Soldered Leads)  
 3 = Fast-on term. (Gate and Aux. Cathode Soldered Leads)
- 10** - Critical dv/dt:  
 None = 500V/μsec (Standard value)  
 L = 1000V/μsec (Special selection)

dv/dt - t <sub>q</sub> combinations available					
dv/dt (V/μs)	20	50	100	200	400
10	CN	DN	EN	--	--
12	CM	DM	EM	<b>FM</b> *	--
15	CL	DL	EL	<b>FL</b> *	HL
18	CP	DP	EP	FP	HP
20	CK	DK	EK	FK	HK
25	--	--	--	FJ	HJ
30	--	--	--	--	HH

\*Standard part number.  
All other types available only on request.

Outline Table

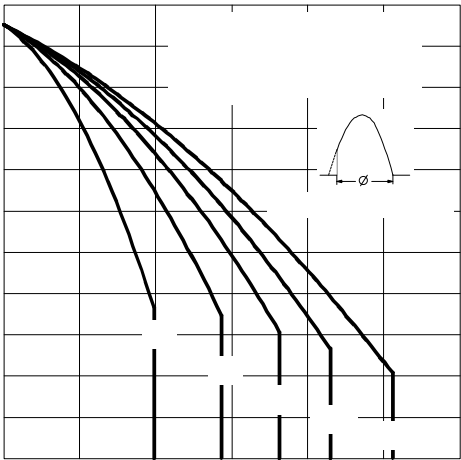
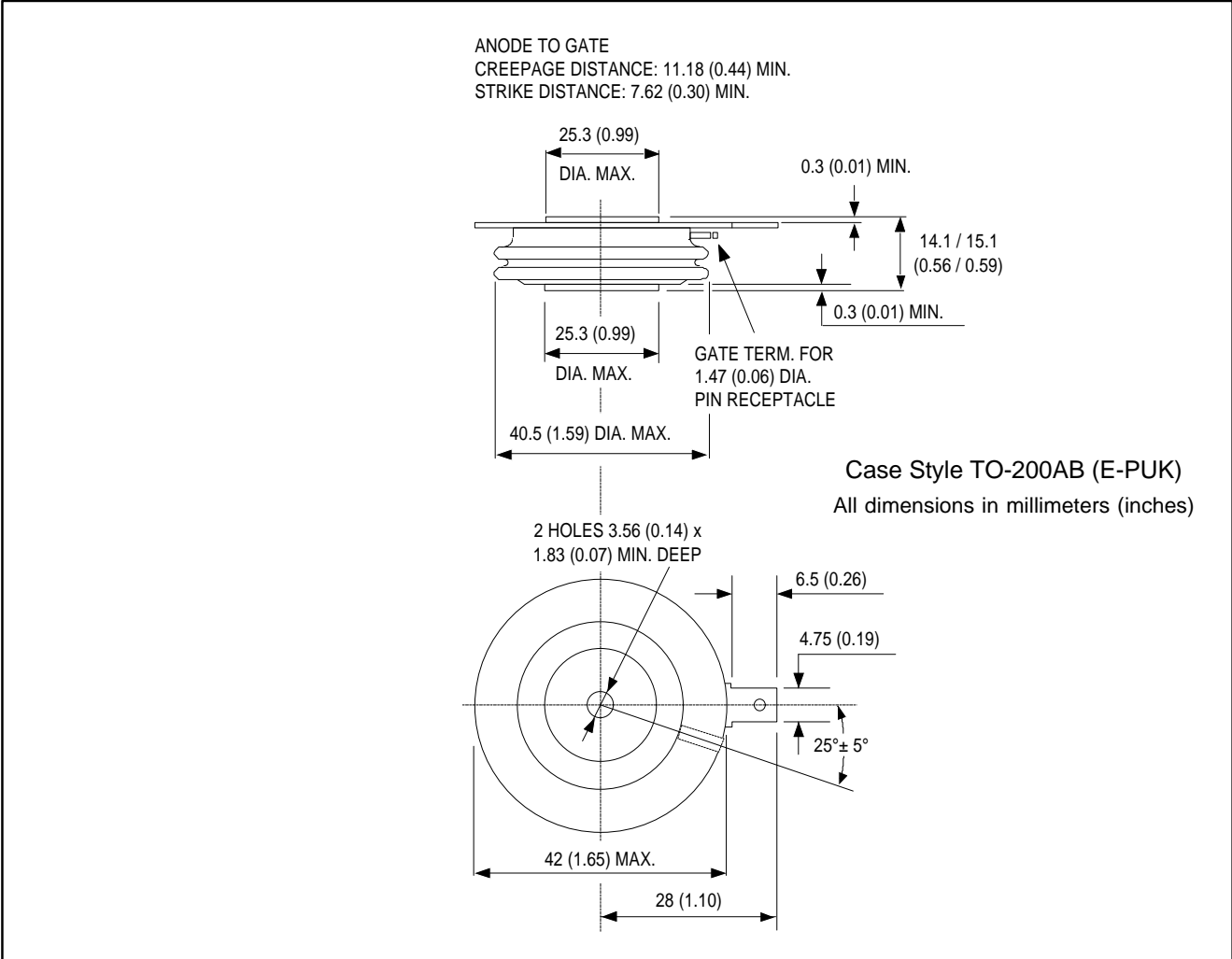

Fig. 1 - Current Ratings Characteristics

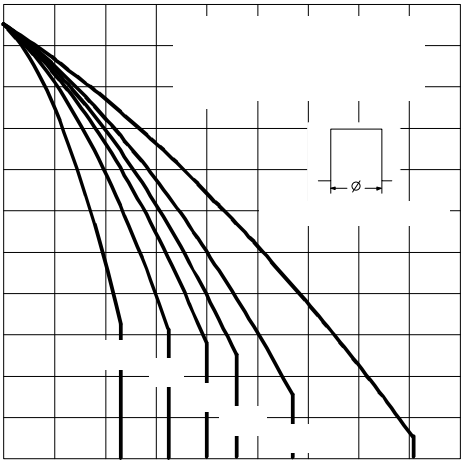

Fig. 2 - Current Ratings Characteristics