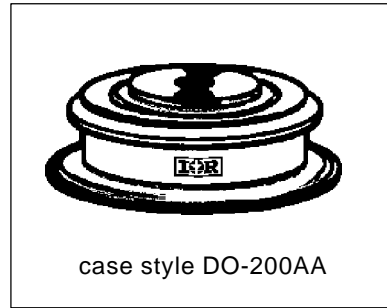

FAST RECOVERY DIODES
Hockey Puk Version
Features

- High power FAST recovery diode series
- 1.0 to 2.0 μs recovery time
- High voltage ratings up to 2500V
- High current capability
- Optimized turn on and turn off characteristics
- Low forward recovery
- Fast and soft reverse recovery
- Press-puk encapsulation
- Case style conform to JEDEC DO-200AA
- Maximum junction temperature 125°C

350A

case style DO-200AA

Typical Applications

- Snubber diode for GTO
- High voltage free-wheeling diode
- Fast recovery rectifier applications

Major Ratings and Characteristics

Parameters	SD303C..C	Units
$I_{F(AV)}$	350	A
@ T_{hs}	55	°C
$I_{F(RMS)}$	550	A
@ T_{hs}	25	°C
I_{FSM}	@ 50Hz 5770	A
	@ 60Hz 6040	A
I^2t	@ 50Hz 166	KA ² s
	@ 60Hz 152	KA ² s
V_{RRM} range	400 to 2500	V
t_{rr} range	1.0 to 2.0	μs
@ T_J	25	°C
T_J	- 40 to 125	°C

SD303C..C Series

ELECTRICAL SPECIFICATIONS

Voltage Ratings

Type number	Voltage Code	V_{RRM} max. repetitive peak and off-state voltage V	V_{RSM} , maximum non-repetitive peak voltage V	I_{RRM} max. $T_J = 125^\circ\text{C}$ mA
SD303C..S10C	04	400	500	35
	08	800	900	
	10	1000	1100	
SD303C..S15C	12	1200	1300	
	14	1400	1500	
	16	1600	1700	
SD303C..S20C	20	2000	2100	
	25	2500	2600	

Forward Conduction

Parameter	SD303C..C	Units	Conditions		
$I_{F(AV)}$ Max. average forward current @ Heatsink temperature	350(175)	A	180° conduction, half sine wave.		
	55(75)	$^\circ\text{C}$	Double side (single side) cooled		
$I_{F(RMS)}$ Max. RMS current	550	A	@ 25°C heatsink temperature double side cooled		
I_{FSM} Max. peak, one-cycle non-repetitive forward current	5770	A	t = 10ms No voltage		
	6040		t = 8.3ms reappplied		
	4850		t = 10ms 100% V_{RRM}		
	5080		t = 8.3ms reappplied		
I^2t Maximum I^2t for fusing	166	KA^2s	t = 10ms No voltage		
	152		t = 8.3ms reappplied		
	117		t = 10ms 100% V_{RRM}		
	107		t = 8.3ms reappplied		
$I^2\sqrt{t}$ Maximum $I^2\sqrt{t}$ for fusing	1660	$\text{KA}^2\sqrt{\text{s}}$	t = 0.1 to 10ms, no voltage reappplied		
	$V_{F(TO)1}$ Low level of threshold voltage		1.14	V	$(16.7\% \times \pi \times I_{F(AV)} < I < \pi \times I_{F(AV)})$, $T_J = T_J \text{ max.}$
	$V_{F(TO)2}$ High level of threshold voltage		1.63		$(I > \pi \times I_{F(AV)})$, $T_J = T_J \text{ max.}$
	r_{f1} Low level of forward slope resistance		1.14	$\text{m}\Omega$	$(16.7\% \times \pi \times I_{F(AV)} < I < \pi \times I_{F(AV)})$, $T_J = T_J \text{ max.}$
r_{f2} High level of forward slope resistance	0.77	$(I > \pi \times I_{F(AV)})$, $T_J = T_J \text{ max.}$			
V_{FM} Max. forward voltage	2.26	V	$I_{pk} = 1100\text{A}$, $T_J = 25^\circ\text{C}$, $t_p = 10\text{ms}$ sinusoidal wave		

Recovery Characteristics

Code	$T_J = 25^\circ\text{C}$ typical t_{rr} @ 25% I_{RRM} (μs)	Test conditions			Max. values @ $T_J = 125^\circ\text{C}$		
		I_{pk} Square Pulse (A)	di/dt ($\text{A}/\mu\text{s}$)	V_r (V)	t_{rr} @ 25% I_{RRM} (μs)	Q_{rr} (μC)	I_{rr} (A)
S10	1.0	750	25	-30	2.4	52	33
S15	1.5				2.9	90	44
S20	2.0				3.2	107	46

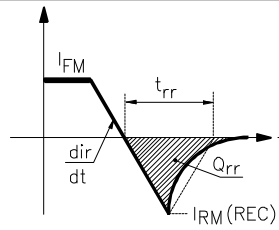

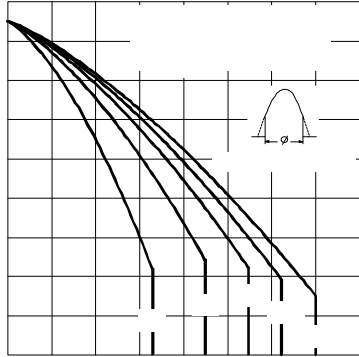

Fig. 3 - Current Ratings Characteristics

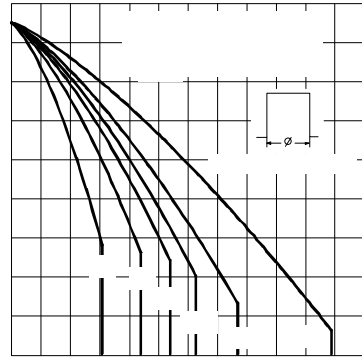

Fig. 4 - Current Ratings Characteristics

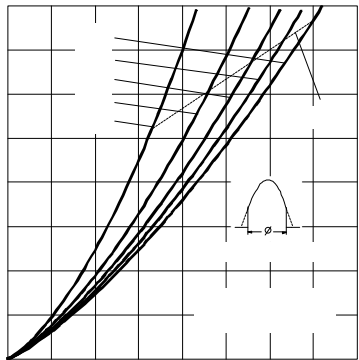

Fig. 5 - Forward Power Loss Characteristics

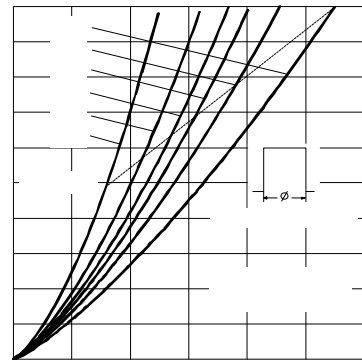

Fig. 6 - Forward Power Loss Characteristics

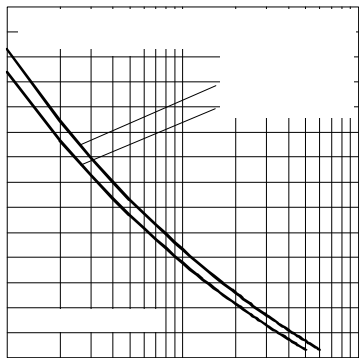

Fig. 7 - Maximum Non-repetitive Surge Current
Single and Double Side Cooled

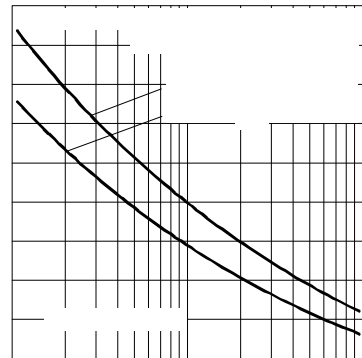

Fig. 8 - Maximum Non-repetitive Surge Current
Single and Double Side Cooled

SD303C..C Series

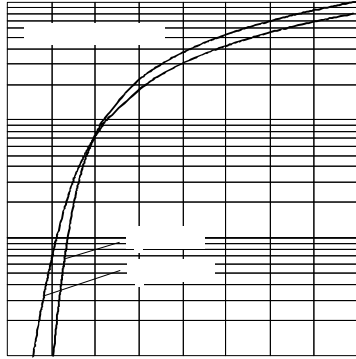

Fig. 9 - Forward Voltage Drop Characteristics

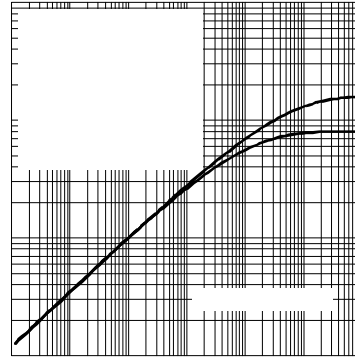

Fig. 10 - Thermal Impedance Z_{th-jhs} Characteristic

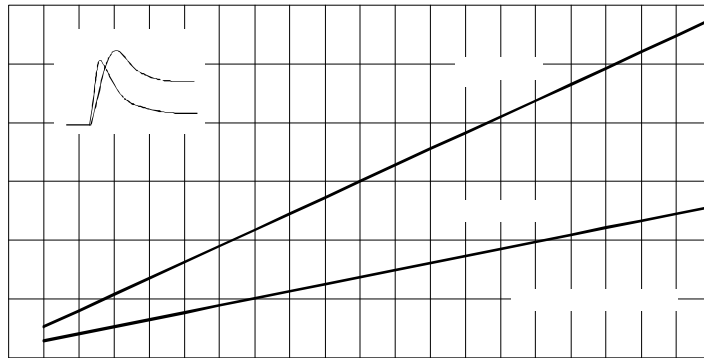

Fig. 11 - Typical Forward Recovery Characteristics

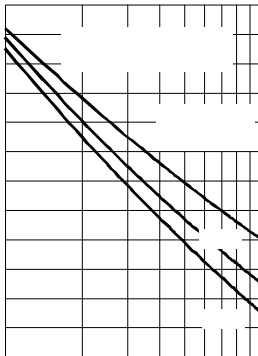

Fig. 12 - Recovery Time Characteristics

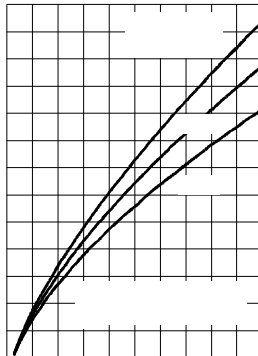

Fig. 13 - Recovery Charge Characteristics

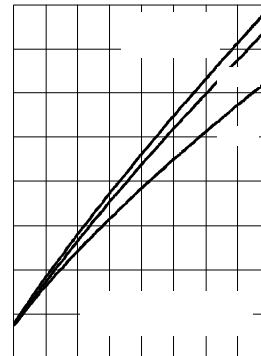

Fig. 14 - Recovery Current Characteristics

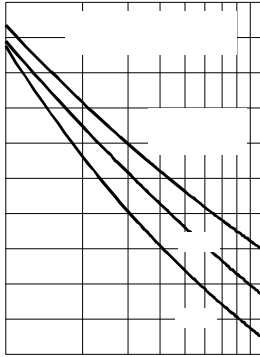

Fig. 15 - Recovery Time Characteristics

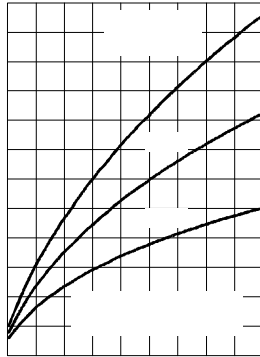

Fig. 16 - Recovery Charge Characteristics

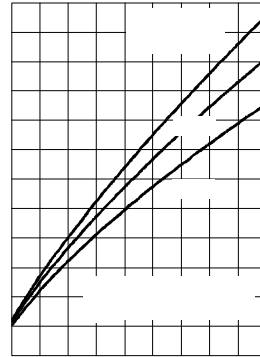

Fig. 17 - Recovery Current Characteristics

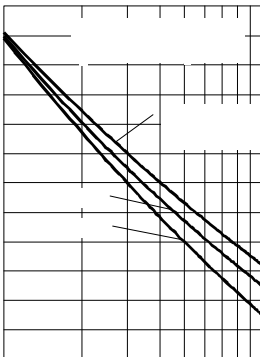

Fig. 18 - Recovery Time Characteristics



Fig. 19 - Recovery Charge Characteristics

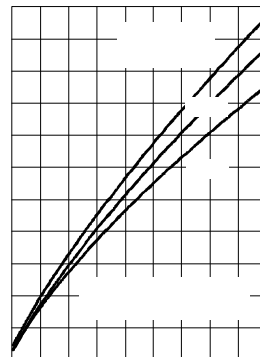

Fig. 20 - Recovery Current Characteristics

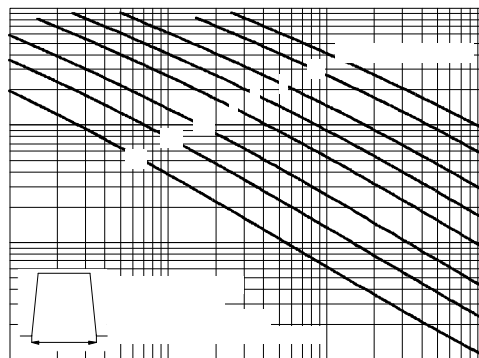
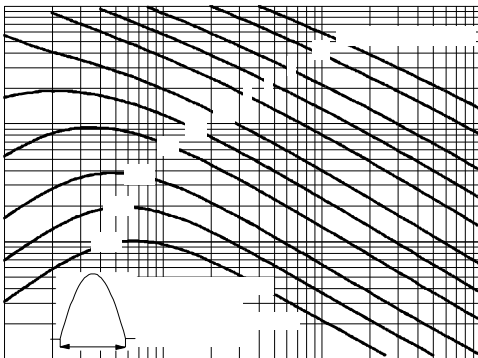

Fig. 21 - Maximum Total Energy Loss Per Pulse Characteristics

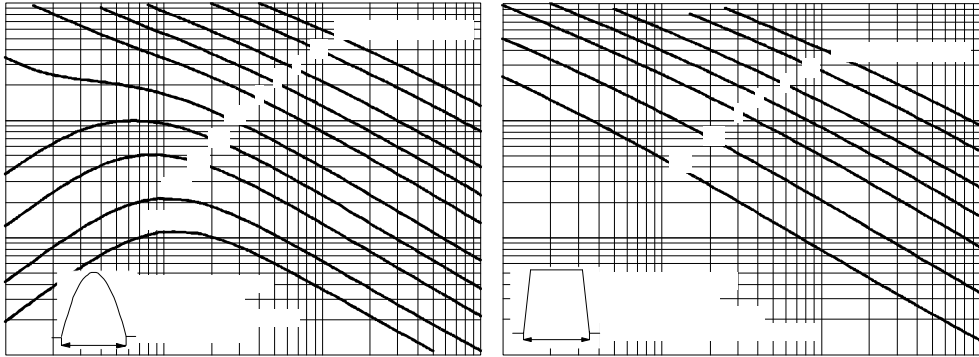

Fig. 22 - Maximum Total Energy Loss Per Pulse Characteristics

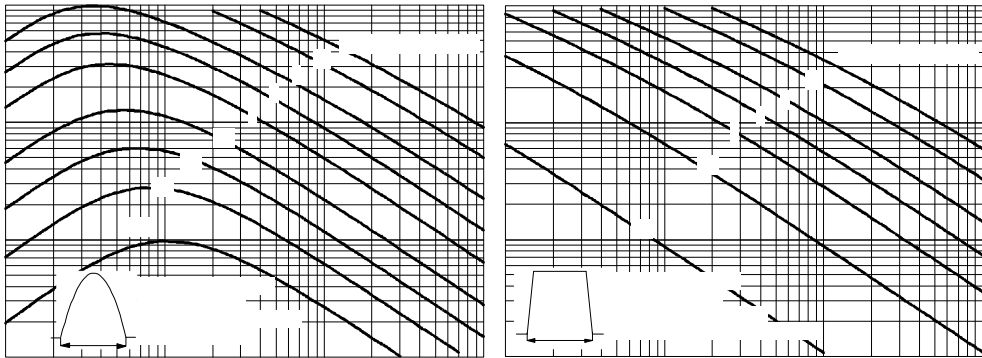

Fig. 23 - Maximum Total Energy Loss Per Pulse Characteristics

Thermal and Mechanical Specifications

Parameter	SD303C..C	Units	Conditions
T_J Max. operating temperature range	-40 to 125	°C	
T_{stg} Max. storage temperature range	-40 to 150		
R_{thJ-hs} Max. thermal resistance, junction to heatsink	0.16	K/W	DC operation single side cooled
	0.08		DC operation double side cooled
F Mounting force, $\pm 10\%$	4900 (500)	N (Kg)	
wt Approximate weight	70	g	
Case style	DO-200AA		See Outline Table

 ΔR_{thJ-hs} Conduction

(The following table shows the increment of thermal resistance R_{thJ-hs} when devices operate at different conduction angles than DC)

Conduction angle	Sinusoidal conduction		Rectangular conduction		Units	Conditions
	Single Side	Double Side	Single Side	Double Side		
180°	0.010	0.011	0.008	0.008	K/W	$T_J = T_J \text{ max.}$
120°	0.012	0.013	0.013	0.013		
90°	0.016	0.016	0.018	0.018		
60°	0.024	0.024	0.025	0.025		
30°	0.042	0.042	0.042	0.042		

Ordering Information Table

Device Code															
	<table border="1" style="display: inline-table; border-collapse: collapse;"> <tr> <td style="padding: 2px 5px;">SD</td> <td style="padding: 2px 5px;">30</td> <td style="padding: 2px 5px;">3</td> <td style="padding: 2px 5px;">C</td> <td style="padding: 2px 5px;">25</td> <td style="padding: 2px 5px;">S20</td> <td style="padding: 2px 5px;">C</td> </tr> <tr> <td style="text-align: center;">1</td> <td style="text-align: center;">2</td> <td style="text-align: center;">3</td> <td style="text-align: center;">4</td> <td style="text-align: center;">5</td> <td style="text-align: center;">6</td> <td style="text-align: center;">7</td> </tr> </table>	SD	30	3	C	25	S20	C	1	2	3	4	5	6	7
SD	30	3	C	25	S20	C									
1	2	3	4	5	6	7									
1	- Diode														
2	- Essential part number														
3	- 3 = Fast recovery														
4	- C = Ceramic Puk														
5	- Voltage code: Code x 100 = V_{RRM} (see Voltage Ratings table)														
6	- t_{rr} code (see Recovery Characteristics table)														
7	- C = Puk Case DO-200AA														

SD303C..C Series

Outline Table

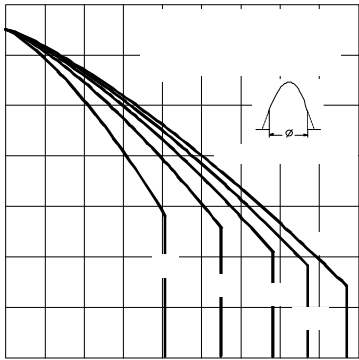
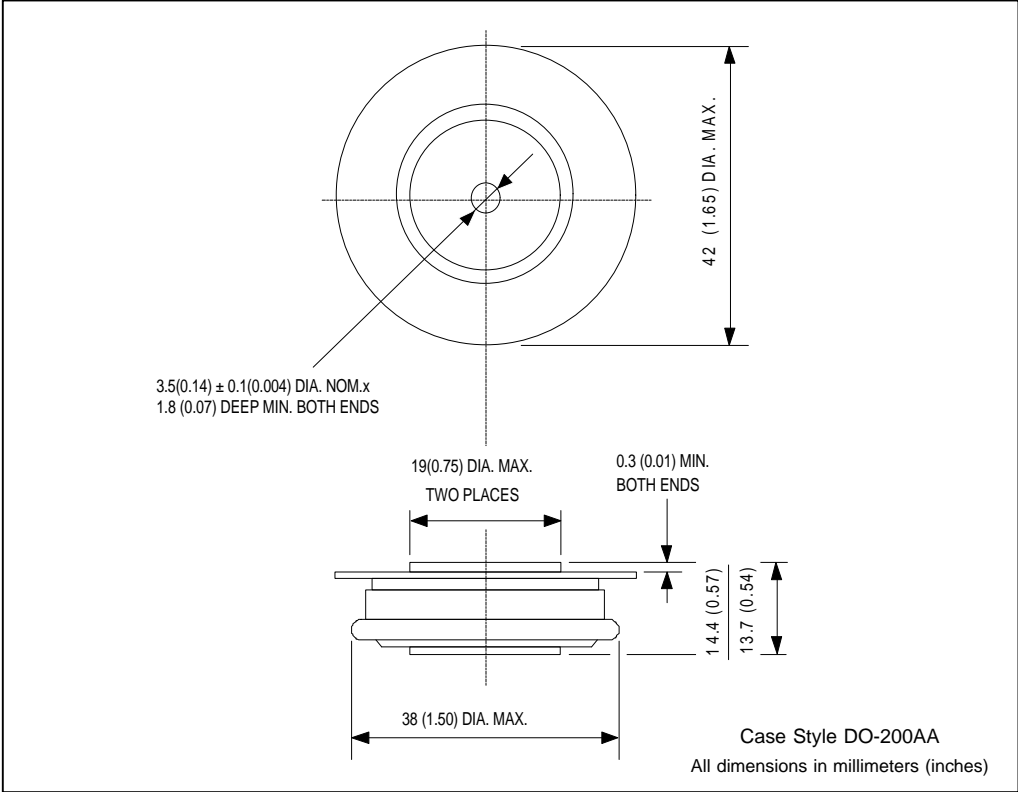

Fig. 1 - Current Ratings Characteristics

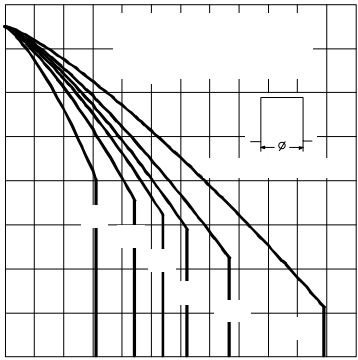

Fig. 2 - Current Ratings Characteristics