



DISCRETE POWER DIODES and THYRISTORS
DATA BOOK

FAST RECOVERY DIODES
Hockey Puk Version
Features

- High power FAST rectifier diode series
- 5.0 μ s recovery time
- High voltage ratings up to 4500V
- High current capability
- Optimized turn on and turn off characteristics
- Low forward recovery
- Fast and soft reverse recovery
- Press-puk encapsulation
- Case style conform to JEDEC DO-200AC (K-PUK)
- Maximum junction temperature 125°C

990A



case style DO-200AC (K-PUK)

Typical Applications

- Snubber diode for GTO
- High voltage free-wheeling diode
- Fast recovery rectifier applications

Major Ratings and Characteristics

Parameters	SD853C..S50K	Units
$I_{F(AV)}$	990	A
@ T_{hs}	55	°C
$I_{F(RMS)}$	1800	A
@ T_{hs}	25	°C
I_{FSM}	@ 50Hz 19000	A
	@ 60Hz 19900	A
I^2t	@ 50Hz 1810	KA ² s
	@ 60Hz 1652	KA ² s
V_{RRM} range	3000 to 4500	V
t_{rr}	5.0	μ s
@ T_J	25	°C
T_J	- 40 to 125	°C

SD853C..S50K Series

ELECTRICAL SPECIFICATIONS

Voltage Ratings

Type number	Voltage Code	V_{RRM} , maximum repetitive peak reverse voltage V	V_{RSM} , maximum non-repetitive peak rev. voltage V	I_{RRM} max. @ $T_J = 125^\circ\text{C}$ mA
SD853C..S50K	30	3000	3100	100
	36	3600	3700	
	40	4000	4100	
	45	4500	4600	

Forward Conduction

Parameter	SD853C..S50K	Units	Conditions
$I_{F(AV)}$ Max. average forward current @ Heatsink temperature	990 (420)	A	180° conduction, half sine wave
	55 (85)	$^\circ\text{C}$	Double side (single side) cooled
$I_{F(RMS)}$ Max. RMS forward current	1800	A	@ 25°C heatsink temperature double side cooled
I_{FSM} Max. peak, one-cycle forward, non-repetitive surge current	19000	A	t = 10ms No voltage
	19900		t = 8.3ms reappplied
	16000		t = 10ms 50% V_{RRM}
	16750		t = 8.3ms reappplied
I^2t Maximum I^2t for fusing	1805	KA ² s	t = 10ms No voltage
	1645		t = 8.3ms reappplied
	1280		t = 10ms 50% V_{RRM}
	1165		t = 8.3ms reappplied
$I^2\sqrt{t}$ Maximum $I^2\sqrt{t}$ for fusing	18050	KA ² \sqrt{s}	t = 0.1 to 10ms, no voltage reappplied
$V_{F(TO)1}$ Low level value of threshold voltage	1.50	V	$(16.7\% \times \pi \times I_{F(AV)} < I < \pi \times I_{F(AV)})$, $T_J = T_J$ max.
$V_{F(TO)2}$ High level value of threshold voltage	1.67		$(I > \pi \times I_{F(AV)})$, $T_J = T_J$ max.
r_{f1} Low level value of forward slope resistance	0.70	m Ω	$(16.7\% \times \pi \times I_{F(AV)} < I < \pi \times I_{F(AV)})$, $T_J = T_J$ max.
r_{f2} High level value of forward slope resistance	0.65		$(I > \pi \times I_{F(AV)})$, $T_J = T_J$ max.
V_{FM} Max. forward voltage drop	2.90	V	$I_{pk} = 2000\text{A}$, $T_J = 125^\circ\text{C}$, $t_p = 10\text{ms}$ sinusoidal wave

Recovery Characteristics

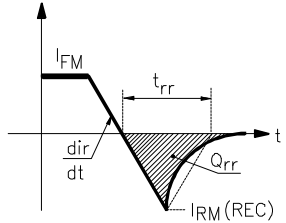
Code	$T_J = 25^\circ\text{C}$ typical t_{rr} @ 25% I_{RRM} (μs)	Test conditions			Max. values @ $T_J = 125^\circ\text{C}$			
		I_{pk} Square Pulse (A)	di/dt (*) (A/ μs)	V_r (V)	t_{rr} @ 25% I_{RRM} (μs)	Q_{rr} (μC)	I_{rr} (A)	
S50	5.0	1000	100	-50	6.5	1000	270	

SD853C..S50K Series

ELECTRICAL SPECIFICATIONS

Voltage Ratings

Type number	Voltage Code	V_{RRM} , maximum repetitive peak reverse voltage V	V_{RSM} , maximum non-repetitive peak rev. voltage V	I_{RRM} max. @ $T_J = 125^\circ\text{C}$ mA
SD853C..S50K	30	3000	3100	100
	36	3600	3700	
	40	4000	4100	
	45	4500	4600	

Forward Conduction

Parameter	SD853C..S50K	Units	Conditions
$I_{F(AV)}$ Max. average forward current @ Heatsink temperature	990 (420)	A	180° conduction, half sine wave
	55 (85)	$^\circ\text{C}$	Double side (single side) cooled
$I_{F(RMS)}$ Max. RMS forward current	1800	A	@ 25°C heatsink temperature double side cooled
I_{FSM} Max. peak, one-cycle forward, non-repetitive surge current	19000	A	t = 10ms No voltage
	19900		t = 8.3ms reappplied
	16000		t = 10ms 50% V_{RRM}
	16750		t = 8.3ms reappplied
I^2t Maximum I^2t for fusing	1805	KA ² s	t = 10ms No voltage
	1645		t = 8.3ms reappplied
	1280		t = 10ms 50% V_{RRM}
	1165		t = 8.3ms reappplied
$I^2\sqrt{t}$ Maximum $I^2\sqrt{t}$ for fusing	18050	KA ² \sqrt{s}	t = 0.1 to 10ms, no voltage reappplied
$V_{F(TO)1}$ Low level value of threshold voltage	1.50	V	(16.7% $\times \pi \times I_{F(AV)} < I < \pi \times I_{F(AV)}$), $T_J = T_J$ max.
$V_{F(TO)2}$ High level value of threshold voltage	1.67		($I > \pi \times I_{F(AV)}$), $T_J = T_J$ max.
r_{f1} Low level value of forward slope resistance	0.70	m Ω	(16.7% $\times \pi \times I_{F(AV)} < I < \pi \times I_{F(AV)}$), $T_J = T_J$ max.
r_{f2} High level value of forward slope resistance	0.65		($I > \pi \times I_{F(AV)}$), $T_J = T_J$ max.
V_{FM} Max. forward voltage drop	2.90	V	$I_{pk} = 2000\text{A}$, $T_J = 125^\circ\text{C}$, $t_p = 10\text{ms}$ sinusoidal wave

Recovery Characteristics

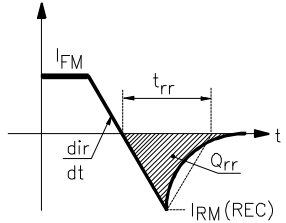
Code	$T_J = 25^\circ\text{C}$ typical t_{rr} @ 25% I_{RRM} (μs)	Test conditions			Max. values @ $T_J = 125^\circ\text{C}$			
		I_{pk} Square Pulse (A)	di/dt (*) (A/ μs)	V_r (V)	t_{rr} @ 25% I_{RRM} (μs)	Q_{rr} (μC)	I_{rr} (A)	
S50	5.0	1000	100	-50	6.5	1000	270	

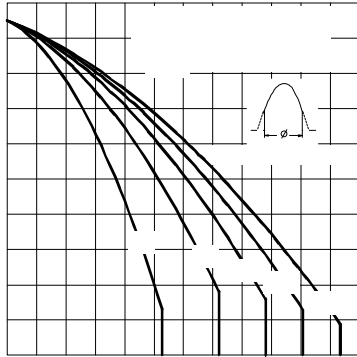

Fig. 3 - Current Ratings Characteristics

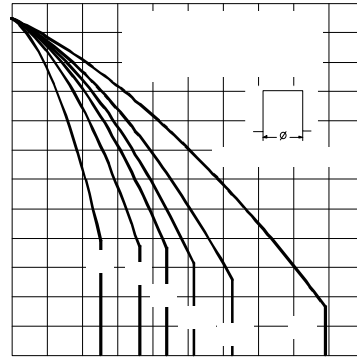

Fig. 4 - Current Ratings Characteristics

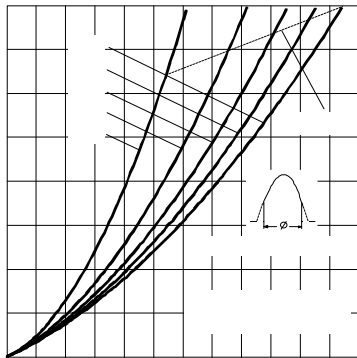

Fig. 5 - Forward Power Loss Characteristics

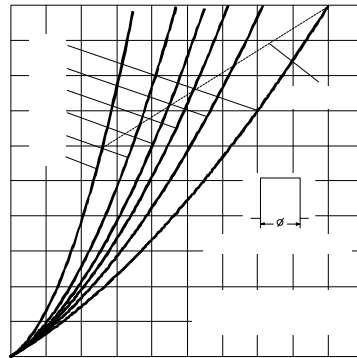

Fig. 6 - Forward Power Loss Characteristics

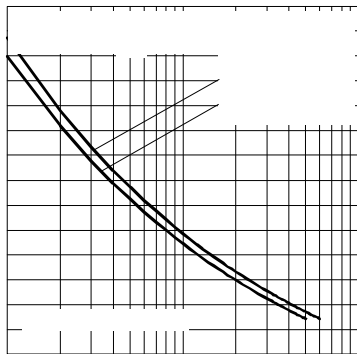

Fig. 7 - Maximum Non-repetitive Surge Current
Single and Double Side Cooled

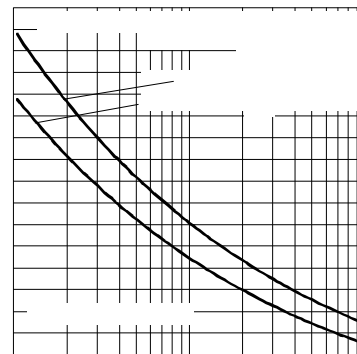

Fig. 8 - Maximum Non-repetitive Surge Current
Single and Double Side Cooled

SD853C..S50K Series

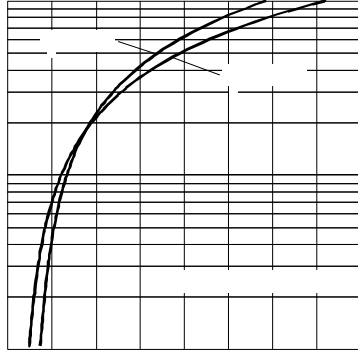

Fig. 9 - Forward Voltage Drop Characteristics

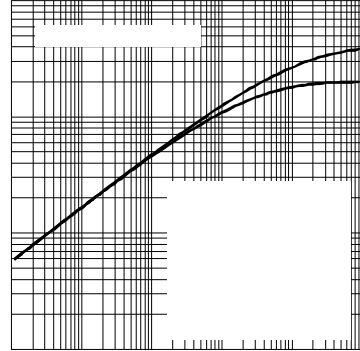

Fig. 10 - Thermal Impedance Z_{thJ-hs} Characteristic

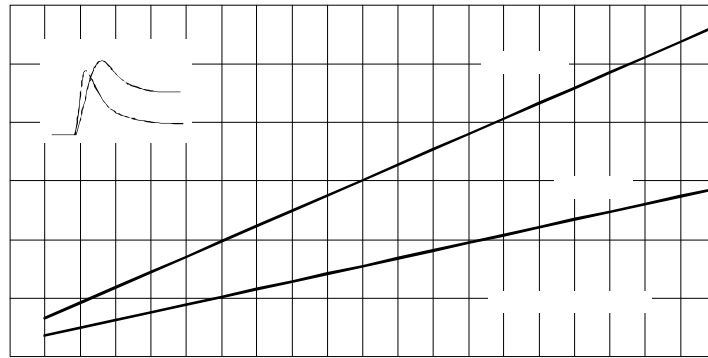

Fig. 11 - Typical Forward Recovery Characteristics

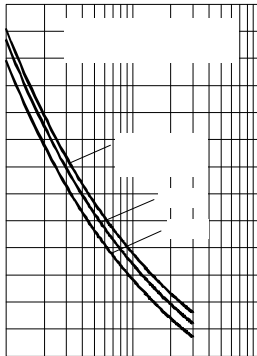

Fig. 12 - Recovery Time Characteristics



Fig. 13 - Recovery Charge Characteristics

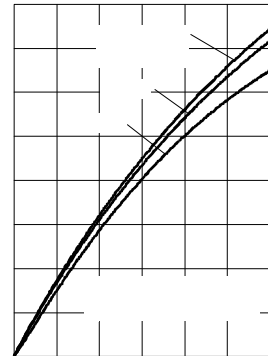

Fig. 14 - Recovery Current Characteristics

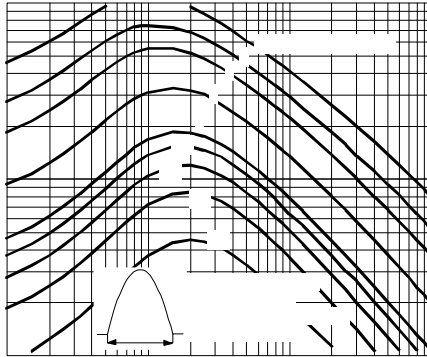

Fig. 15 - Maximum Total Energy Loss Per Pulse Characteristics

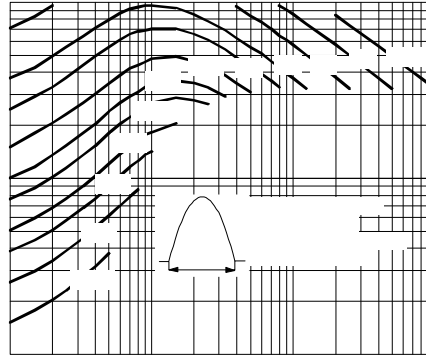

Fig. 16 - Frequency Characteristics

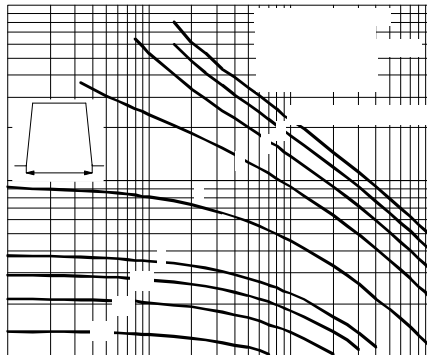

Fig. 17 - Maximum Total Energy Loss Per Pulse Characteristics

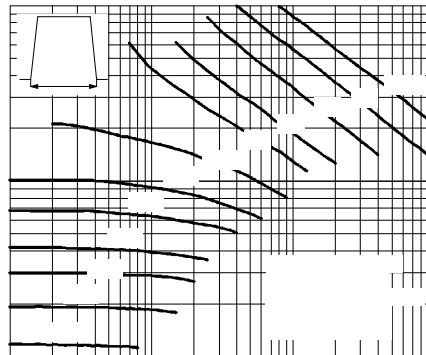

Fig. 18 - Frequency Characteristics

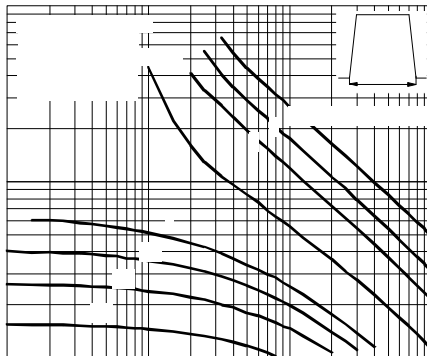

Fig. 19 - Maximum Total Energy Loss Per Pulse Characteristics

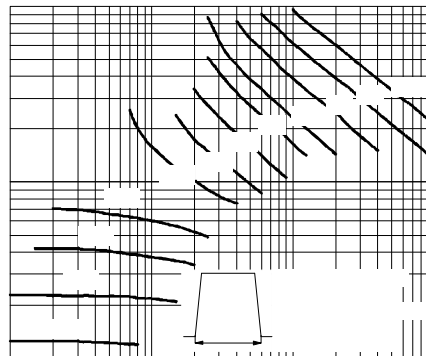

Fig. 20 - Frequency Characteristics

Thermal and Mechanical Specifications

Parameter	SD853C..S50K	Units	Conditions
T_J Max. junction operating temperature range	-40 to 125	°C	
T_{stg} Max. storage temperature range	-40 to 150		
R_{thJ-hs} Max. thermal resistance, junction to heatsink	0.04 0.02	K/W	DC operation single side cooled DC operation double side cooled
F Mounting force, $\pm 10\%$	22250 (2250)	N (Kg)	
wt Approximate weight	425	g	
Case style	DO-200AC (K-PUK)		See outline table

 ΔR_{thJ-hs} Conduction

(The following table shows the increment of thermal resistance R_{thJ-hs} when devices operate at different conduction angles than DC)

Conduction angle	Sinusoidal conduction		Rectangular conduction		Units	Conditions
	Single Side	Double Side	Single Side	Double Side		
180°	0.0017	0.0019	0.0012	0.0012	K/W	$T_J = T_J \text{ max.}$
120°	0.0021	0.0021	0.0021	0.0021		
90°	0.0026	0.0027	0.0029	0.0029		
60°	0.0039	0.0039	0.0041	0.0041		
30°	0.0067	0.0067	0.0068	0.0068		

Ordering Information Table

Device Code	
	<div style="display: flex; justify-content: center; gap: 10px;"> <div style="border: 1px solid black; padding: 2px 5px;">SD</div> <div style="border: 1px solid black; padding: 2px 5px;">85</div> <div style="border: 1px solid black; padding: 2px 5px;">3</div> <div style="border: 1px solid black; padding: 2px 5px;">C</div> <div style="border: 1px solid black; padding: 2px 5px;">45</div> <div style="border: 1px solid black; padding: 2px 5px;">S50</div> <div style="border: 1px solid black; padding: 2px 5px;">K</div> </div>
	<div style="display: flex; justify-content: center; gap: 10px;"> (1) (2) (3) (4) (5) (6) (7) </div>
<div style="display: flex; flex-direction: column; gap: 5px;"> <div style="display: flex; align-items: center;">1 - Diode</div> <div style="display: flex; align-items: center;">2 - Essential part number</div> <div style="display: flex; align-items: center;">3 - 3 = Fast recovery</div> <div style="display: flex; align-items: center;">4 - C = Ceramic Puk</div> <div style="display: flex; align-items: center;">5 - Voltage code: Code x 100 = V_{RRM} (See Voltage Ratings table)</div> <div style="display: flex; align-items: center;">6 - t_{rr} code</div> <div style="display: flex; align-items: center;">7 - K = Puk Case DO-200AC (K-PUK)</div> </div>	

SD853C..S50K Series

Outline Table

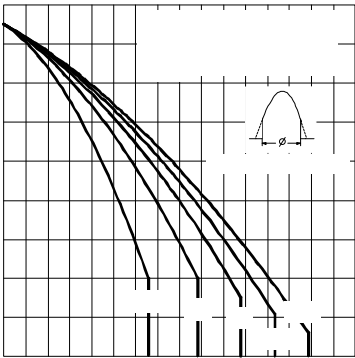
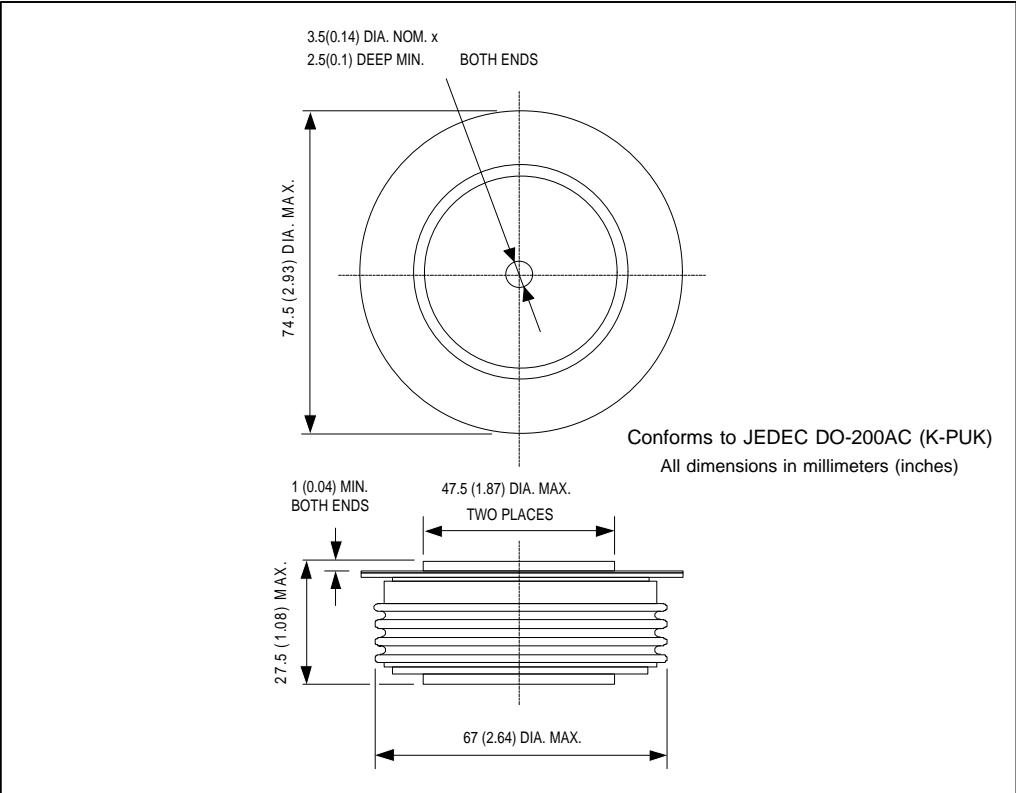

Fig. 1 - Current Ratings Characteristics

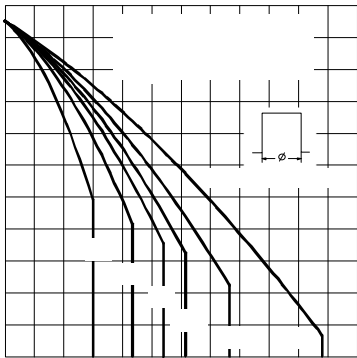

Fig. 2 - Current Ratings Characteristics

Thermal and Mechanical Specifications

Parameter	SD853C..S50K	Units	Conditions
T_J Max. junction operating temperature range	-40 to 125	°C	
T_{stg} Max. storage temperature range	-40 to 150		
R_{thJ-hs} Max. thermal resistance, junction to heatsink	0.04 0.02	K/W	DC operation single side cooled DC operation double side cooled
F Mounting force, $\pm 10\%$	22250 (2250)	N (Kg)	
wt Approximate weight	425	g	
Case style	DO-200AC (K-PUK)		See outline table

 ΔR_{thJ-hs} Conduction

(The following table shows the increment of thermal resistance R_{thJ-hs} when devices operate at different conduction angles than DC)

Conduction angle	Sinusoidal conduction		Rectangular conduction		Units	Conditions
	Single Side	Double Side	Single Side	Double Side		
180°	0.0017	0.0019	0.0012	0.0012	K/W	$T_J = T_J \text{ max.}$
120°	0.0021	0.0021	0.0021	0.0021		
90°	0.0026	0.0027	0.0029	0.0029		
60°	0.0039	0.0039	0.0041	0.0041		
30°	0.0067	0.0067	0.0068	0.0068		

Ordering Information Table

Device Code															
	<table border="1" style="display: inline-table; border-collapse: collapse;"> <tr> <td style="padding: 2px 5px;">SD</td> <td style="padding: 2px 5px;">85</td> <td style="padding: 2px 5px;">3</td> <td style="padding: 2px 5px;">C</td> <td style="padding: 2px 5px;">45</td> <td style="padding: 2px 5px;">S50</td> <td style="padding: 2px 5px;">K</td> </tr> <tr> <td style="text-align: center;">1</td> <td style="text-align: center;">2</td> <td style="text-align: center;">3</td> <td style="text-align: center;">4</td> <td style="text-align: center;">5</td> <td style="text-align: center;">6</td> <td style="text-align: center;">7</td> </tr> </table>	SD	85	3	C	45	S50	K	1	2	3	4	5	6	7
SD	85	3	C	45	S50	K									
1	2	3	4	5	6	7									
1	- Diode														
2	- Essential part number														
3	- 3 = Fast recovery														
4	- C = Ceramic Puk														
5	- Voltage code: Code x 100 = V_{RRM} (See Voltage Ratings table)														
6	- t_{rr} code														
7	- K = Puk Case DO-200AC (K-PUK)														

SD853C..S50K Series

Outline Table

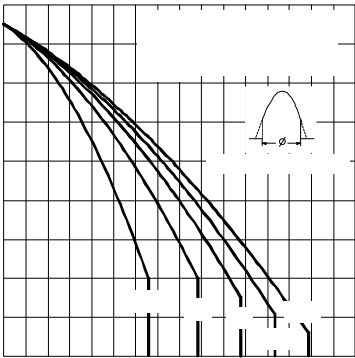
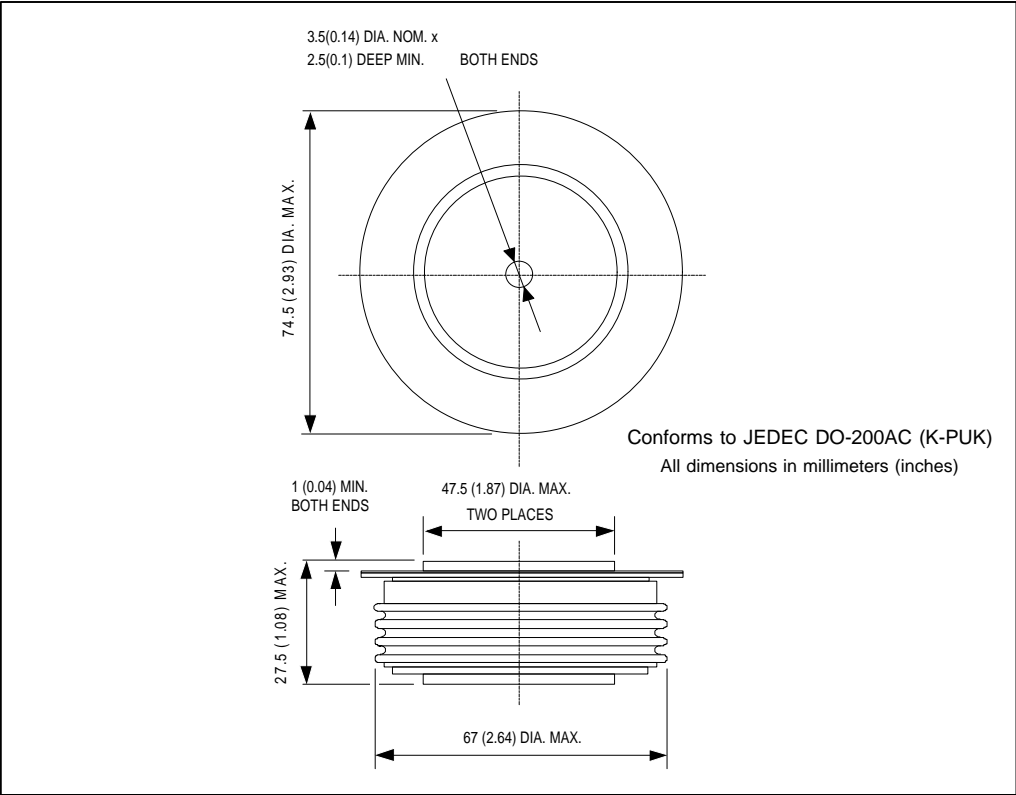

Fig. 1 - Current Ratings Characteristics

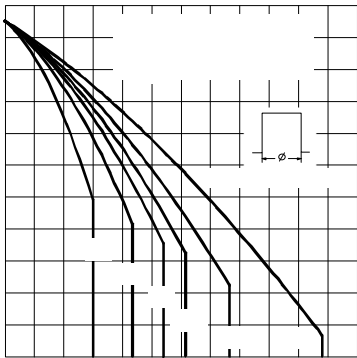

Fig. 2 - Current Ratings Characteristics