

REPETITIVE AVALANCHE AND dv/dt RATED HEXFET® TRANSISTOR

IRFM260

N-CHANNEL

200Volt, 0.060Ω, HEXFET

HEXFET technology is the key to International Rectifier's advanced line of power MOSFET transistors. The efficient geometry design achieves very low on-state resistance combined with high transconductance.

HEXFET transistors also feature all of the well-established advantages of MOSFETs, such as voltage control, very fast switching, ease of paralleling and electrical parameter temperature stability. They are well-suited for applications such as switching power supplies, motor controls, inverters, choppers, audio amplifiers and high-energy pulse circuits, and virtually any application where high reliability is required.

HEXFET transistor's totally isolated package eliminates the need for additional isolating material between the device and the heatsink. This improves thermal efficiency and reduces drain capacitance.

Product Summary

Part Number	BV _{DSS}	R _{DS(on)}	I _D
IRFM260	200V	0.060Ω	35A*

Features:

- Hermetically Sealed
- Electrically Isolated
- Simple Drive Requirements
- Ease of Paralleling
- Ceramic Eyelet

Absolute Maximum Ratings

Pre-Radiation

	Parameter	IRFM260	Units
I _D @ V _{GS} = 10V, T _C = 25°C	Continuous Drain Current	35*	A
I _D @ V _{GS} = 10V, T _C = 100°C	Continuous Drain Current	28	
I _{DM}	Pulsed Drain Current ①	180	
P _D @ T _C = 25°C	Max. Power Dissipation	250	W
	Linear Derating Factor	2.0	W/K ⑤
V _{GS}	Gate-to-Source Voltage	±20	V
EAS	Single Pulse Avalanche Energy ②	700	mJ
I _{AR}	Avalanche Current ①	35	A
EAR	Repetitive Avalanche Energy ①	25	mJ
dv/dt	Peak Diode Recovery dv/dt ③	4.3	V/ns
T _J	Operating Junction	-55 to 150	°C
T _{STG}	Storage Temperature Range		
	Lead Temperature	300(0.063 in.(1.6mm) from case for 10s)	
	Weight	9.3 (typical)	g

Electrical Characteristics @ T_j = 25°C (Unless Otherwise Specified)

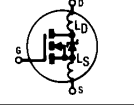
	Parameter	Min	Typ	Max	Units	Test Conditions
BV _{DSS}	Drain-to-Source Breakdown Voltage	200	—	—	V	V _{GS} = 0 V, I _D = 1.0mA
ΔBV _{DSS} /ΔT _J	Temperature Coefficient of Breakdown Voltage	—	0.24	—	V/°C	Reference to 25°C, I _D = 1.0mA
R _{DS(on)}	Static Drain-to-Source On-State Resistance	—	—	0.060	Ω	V _{GS} = 10V, I _D = 28A ④
		—	—	0.068		V _{GS} = 10V, I _D = 35A
V _{GS(th)}	Gate Threshold Voltage	2.0	—	4.0	V	V _{DS} = V _{GS} , I _D = 250μA
g _{fs}	Forward Transconductance	22	—	—	S (r)	V _{DS} > 15V, I _{DS} = 28A ④
I _{DSS}	Zero Gate Voltage Drain Current	—	—	25	μA	V _{DS} = 0.8 x Max Rating, V _{GS} = 0V
		—	—	250		V _{DS} = 0.8 x Max Rating V _{GS} = 0V, T _J = 125°C
I _{GSS}	Gate-to-Source Leakage Forward	—	—	100	nA	V _{GS} = 20 V
I _{GSS}	Gate-to-Source Leakage Reverse	—	—	-100		V _{GS} = -20V
Q _g	Total Gate Charge	—	—	230	nC	V _{GS} = 10V, I _D = 35A V _{DS} = Max Rating x 0.5
Q _{gs}	Gate-to-Source Charge	—	—	40		
Q _{gd}	Gate-to-Drain ('Miller') Charge	—	—	110		
t _{d(on)}	Turn-On Delay Time	—	—	29	ns	V _{DD} = 100V, I _D = 35A, R _G = 2.35Ω
t _r	Rise Time	—	—	120		
t _{d(off)}	Turn-Off Delay Time	—	—	110		
t _f	Fall Time	—	—	92		
L _D	Internal Drain Inductance	—	8.7	—	nH	<p>Measured from drain lead, 6mm (0.25 in) from package to center of die.</p> <p>Measured from source lead, 6mm (0.25 in) from package to source bonding pad.</p> 
L _S	Internal Source Inductance	—	8.7	—		
C _{iss}	Input Capacitance	—	5100	—	pF	V _{GS} = 0V, V _{DS} = 25 V f = 1.0MHz
C _{oss}	Output Capacitance	—	1100	—		
C _{rss}	Reverse Transfer Capacitance	—	280	—		

Source-Drain Diode Ratings and Characteristics

	Parameter	Min	Typ	Max	Units	Test Conditions
I _S	Continuous Source Current (Body Diode)	—	—	35*	A	Modified MOSFET symbol showing the integral reverse p-n junction rectifier. 
I _{SM}	Pulse Source Current (Body Diode) ①	—	—	180		
V _{SD}	Diode Forward Voltage	—	—	1.8	V	T _J = 25°C, I _S = 35A, V _{GS} = 0V ④
t _{rr}	Reverse Recovery Time	—	—	420	ns	T _J = 25°C, I _F = 35A, di/dt ≤ 100A/μs V _{DD} ≤ 50V ④
Q _{RR}	Reverse Recovery Charge	—	—	4.9	μC	
t _{on}	Forward Turn-On Time	Intrinsic turn-on time is negligible. Turn-on speed is substantially controlled by L _S + L _D .				

Thermal Resistance

	Parameter	Min	Typ	Max	Units	Test Conditions
R _{thJC}	Junction-to-Case	—	—	0.50	K/W ⑤	Mounting surface flat, smooth, and greased Typical socket mount
R _{thCS}	Case-to-Sink	—	0.21	—		
R _{thJA}	Junction-to-Ambient	—	—	48		

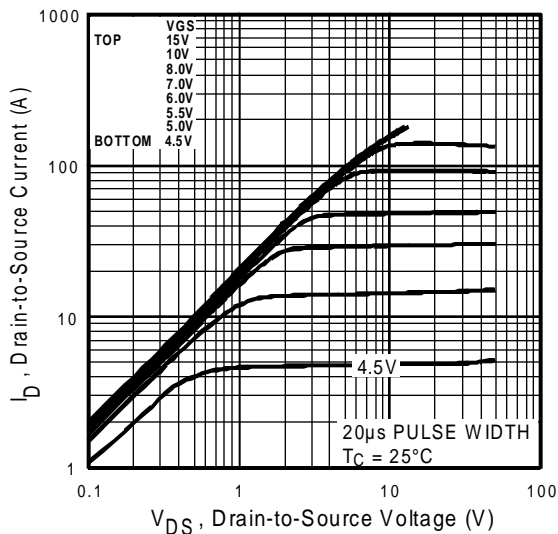

Fig 1. Typical Output Characteristics,
 $T_J = 25^\circ\text{C}$

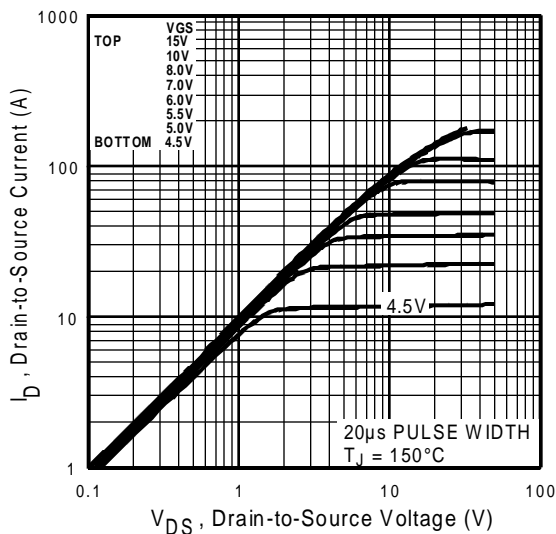

Fig 2. Typical Output Characteristics,
 $T_J = 150^\circ\text{C}$

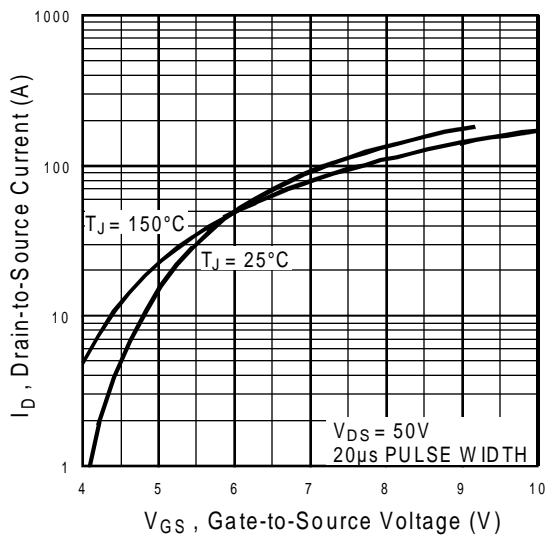

Fig 3. Typical Transfer Characteristics

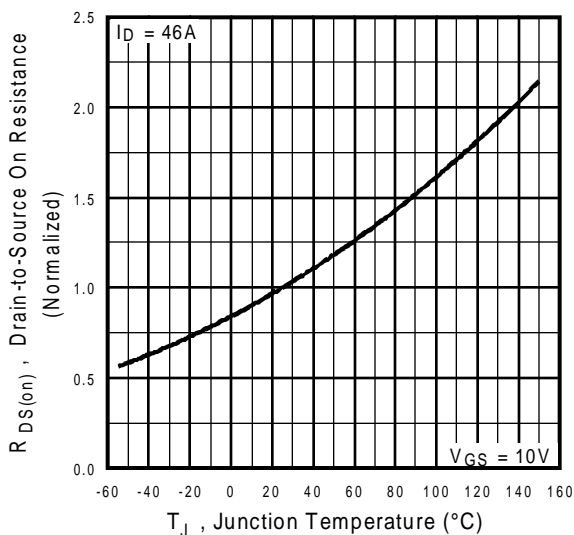

Fig 4. Normalized On-Resistance
Vs. Temperature

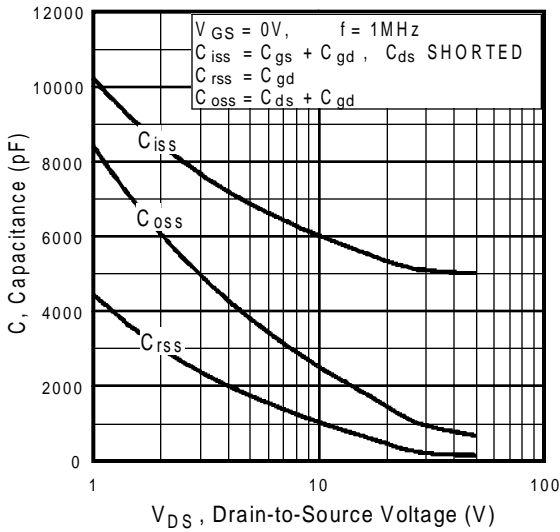

Fig 5. Typical Capacitance Vs. Drain-to-Source Voltage

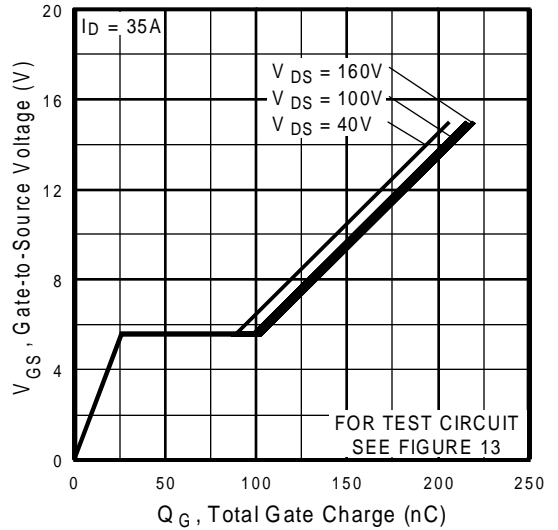

Fig 6. Typical Gate Charge Vs. Gate-to-Source Voltage

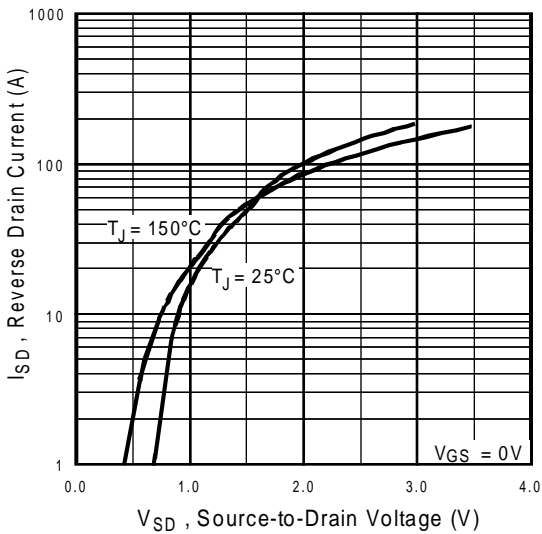

Fig 7. Typical Source-Drain Diode Forward Voltage

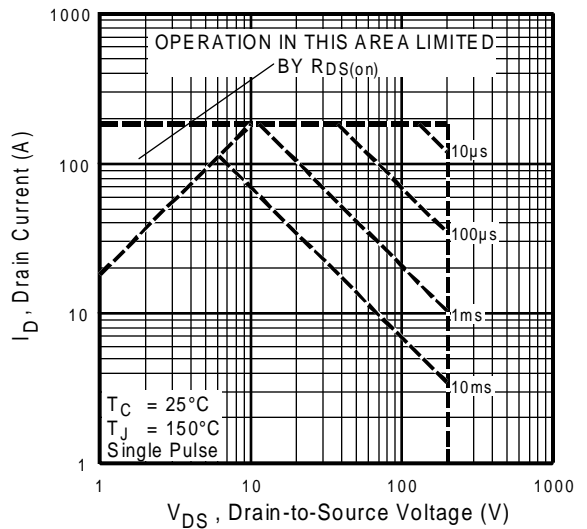

Fig 8. Maximum Safe Operating Area

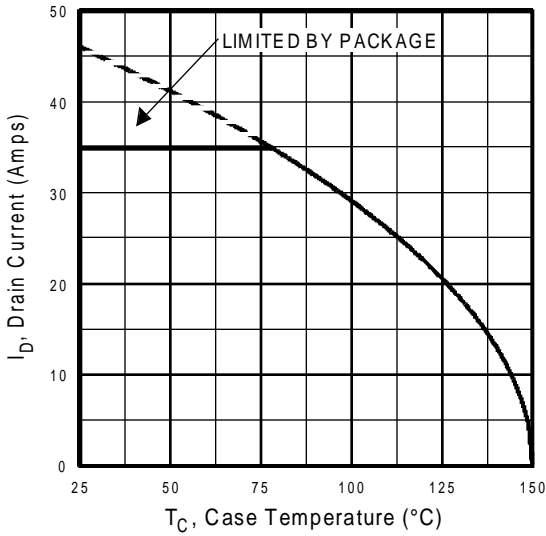

Fig 9. Maximum Drain Current Vs. Case Temperature

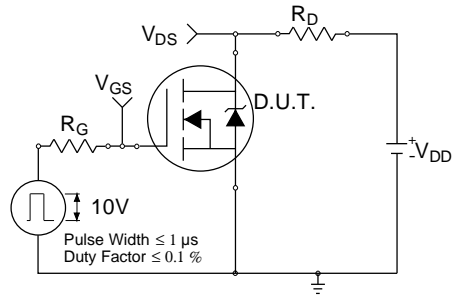

Fig 10a. Switching Time Test Circuit

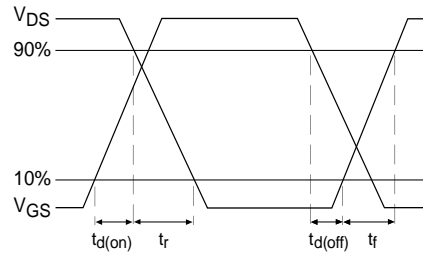

Fig 10b. Switching Time Waveforms

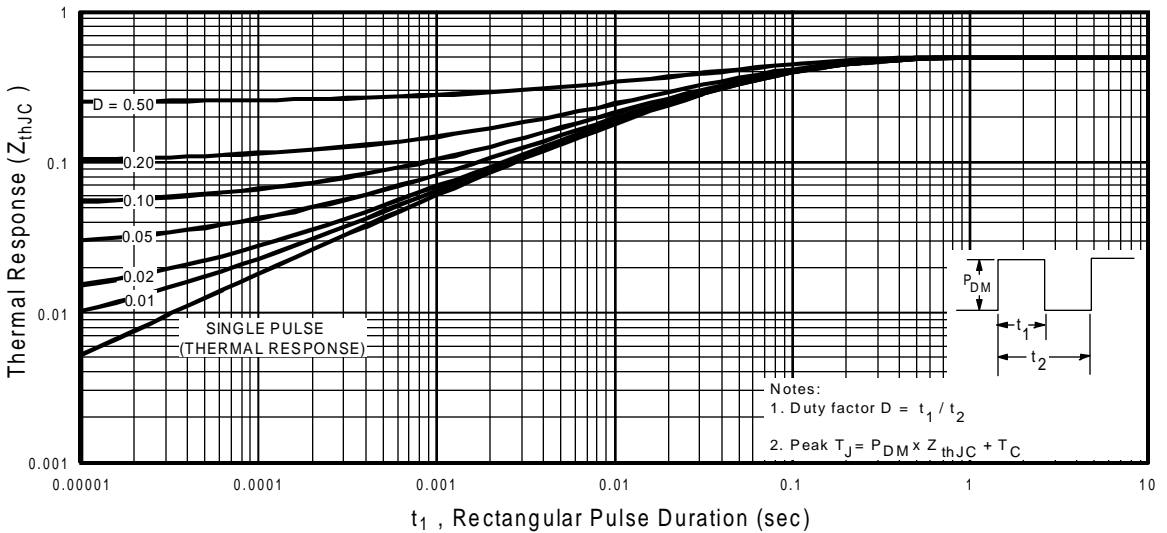

Fig 11. Maximum Effective Transient Thermal Impedance, Junction-to-Case

IRFM260

International
IR Rectifier

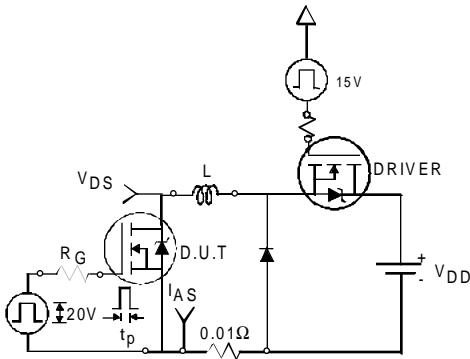

Fig 12a. Unclamped Inductive Test Circuit

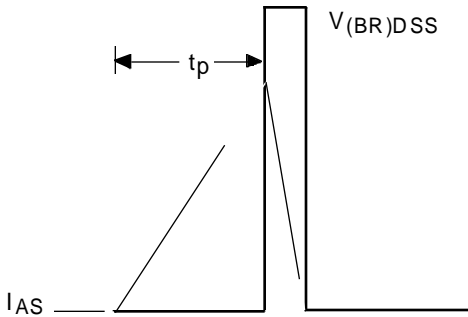

Fig 12b. Unclamped Inductive Waveforms

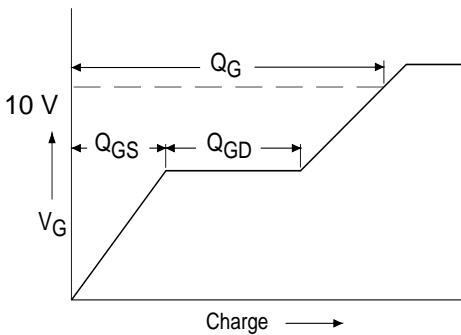

Fig 13a. Basic Gate Charge Waveform

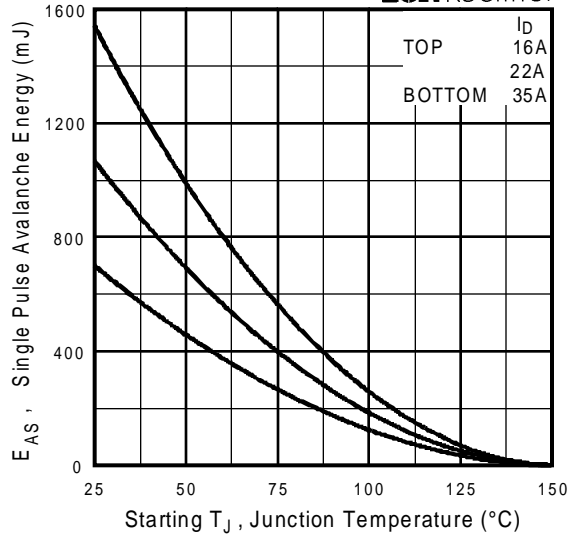

Fig 12c. Maximum Avalanche Energy Vs. Drain Current

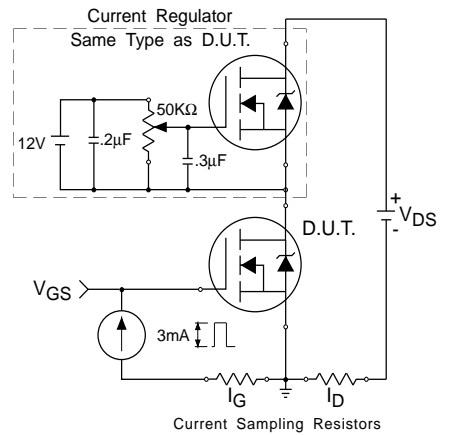
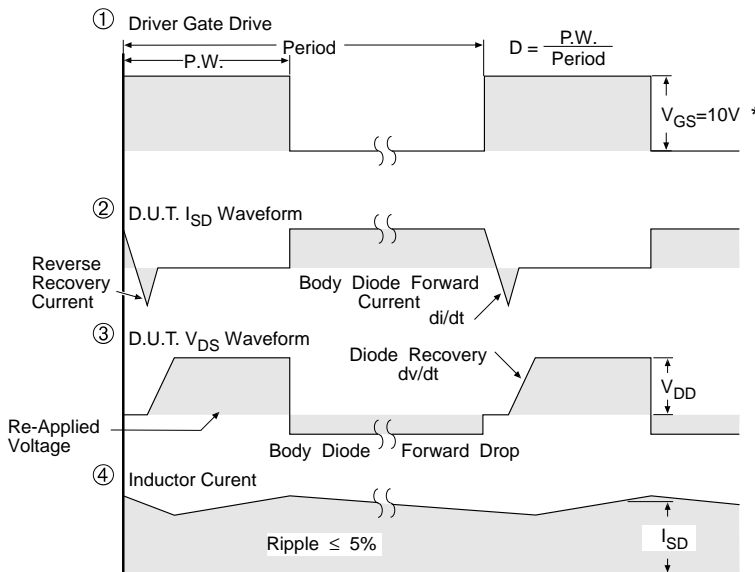
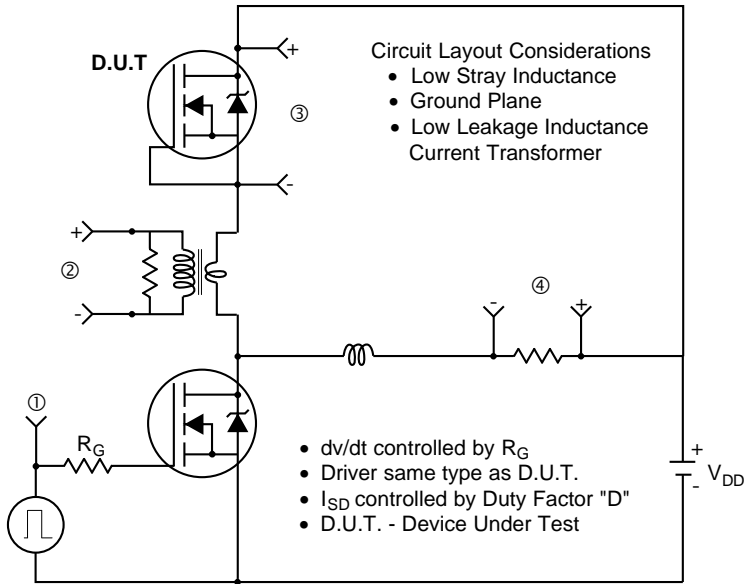

Fig 13b. Gate Charge Test Circuit

Peak Diode Recovery dv/dt Test Circuit



* $V_{GS} = 5V$ for Logic Level Devices

Fig 14. For N-Channel HEXFETS

Case Outline and Dimensions — TO-254AA

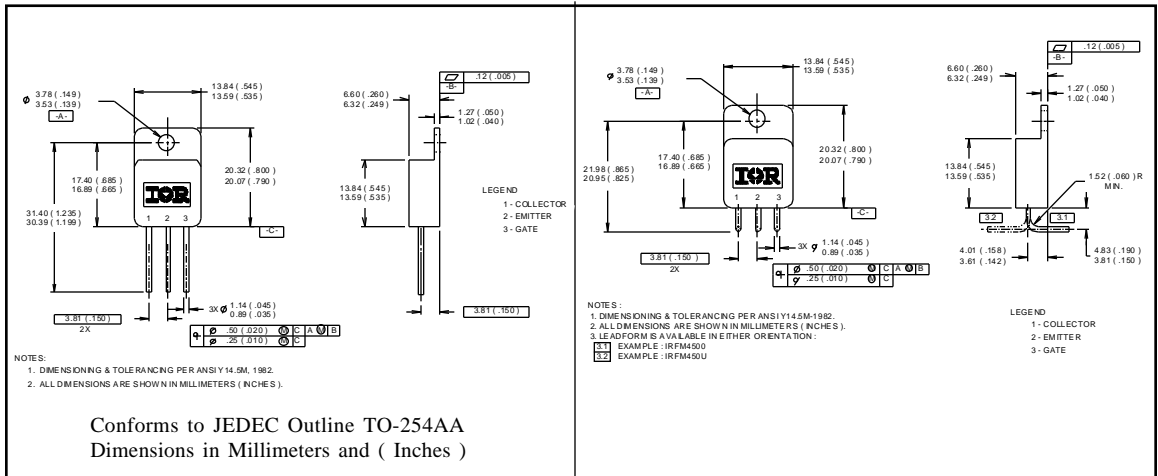

CAUTION

BERYLLIA WARNING PER MIL-PRF-19500

Packages containing beryllia shall not be ground, sand-blasted, machined, or have other operations performed on them which will produce beryllia or beryllium dust. Furthermore, beryllium oxide packages shall not be placed in acids that will produce fumes containing beryllium.

Notes:

- ① Repetitive Rating; Pulse width limited by maximum junction temperature. Refer to current HEXFET reliability report.
 - ② @ VDD = 50 V, Starting TJ = 25°C, EAS = [0.5 * L * (IL²)] Peak IL = 35A, VGS=10 V, 25 ≤ RG ≤ 200Ω
 - ③ ISD ≤ 35A, di/dt ≤ 130 A/μs, VDD ≤ BVDS, TJ ≤ 150°C Suggested RG = 2.35Ω
 - ④ Pulse width ≤ 300 μs; Duty Cycle ≤ 2%
 - ⑤ K/W = °C/W
- * ID current limited by pin diamete (Die Current = 46A)