

IRGBC20UD2

INSULATED GATE BIPOLAR TRANSISTOR
WITH ULTRAFAST SOFT RECOVERY DIODE

UltraFast CoPack IGBT

Features

- Switching-loss rating includes all "tail" losses
- HEXFRED™ soft ultrafast diodes
- Optimized for high operating frequency (over 5kHz)
See Fig. 1 for Current vs. Frequency curve

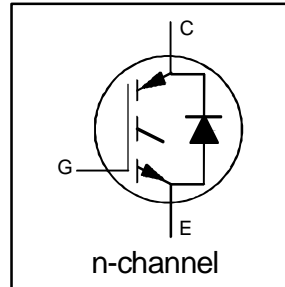

$V_{CES} = 600V$
$V_{CE(sat)} \leq 3.0V$
@ $V_{GE} = 15V, I_C = 6.5A$

Description

Co-packaged IGBTs are a natural extension of International Rectifier's well known IGBT line. They provide the convenience of an IGBT and an ultrafast recovery diode in one package, resulting in substantial benefits to a host of high-voltage, high-current, motor control, UPS and power supply applications.

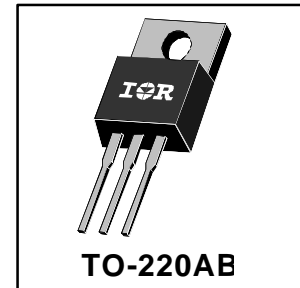

Absolute Maximum Ratings

	Parameter	Max.	Units
V_{CES}	Collector-to-Emitter Voltage	600	V
$I_C @ T_C = 25^\circ C$	Continuous Collector Current	13	A
$I_C @ T_C = 100^\circ C$	Continuous Collector Current	6.5	
I_{CM}	Pulsed Collector Current ①	52	
I_{LM}	Clamped Inductive Load Current ②	52	
$I_F @ T_C = 100^\circ C$	Diode Continuous Forward Current	7.0	
I_{FM}	Diode Maximum Forward Current	52	
V_{GE}	Gate-to-Emitter Voltage	± 20	V
$P_D @ T_C = 25^\circ C$	Maximum Power Dissipation	60	W
$P_D @ T_C = 100^\circ C$	Maximum Power Dissipation	24	
T_J	Operating Junction and Storage Temperature Range	-55 to +150	°C
T_{STG}			
	Mounting Torque, 6-32 or M3 Screw.	10 lbf•in (1.1 N•m)	

Thermal Resistance

	Parameter	Min.	Typ.	Max.	Units
$R_{\theta JC}$	Junction-to-Case - IGBT	—	—	2.1	°C/W
$R_{\theta JC}$	Junction-to-Case - Diode	—	—	3.5	
$R_{\theta CS}$	Case-to-Sink, flat, greased surface	—	0.50	—	
$R_{\theta JA}$	Junction-to-Ambient, typical socket mount	—	—	80	
W_t	Weight	—	2 (0.07)	—	g (oz)

Electrical Characteristics @ $T_J = 25^\circ\text{C}$ (unless otherwise specified)

	Parameter	Min.	Typ.	Max.	Units	Conditions
$V_{(BR)CES}$	Collector-to-Emitter Breakdown Voltage ③	600	—	—	V	$V_{GE} = 0V, I_C = 250\mu\text{A}$
$\Delta V_{(BR)CES}/\Delta T_J$	Temp. Coeff. of Breakdown Voltage	—	0.69	—	V/°C	$V_{GE} = 0V, I_C = 1.0\text{mA}$
$V_{CE(on)}$	Collector-to-Emitter Saturation Voltage	—	2.2	3.0	V	$I_C = 6.5\text{A}$ $V_{GE} = 15V$ See Fig. 2, 5
		—	2.8	—		$I_C = 13\text{A}$
		—	2.5	—		$I_C = 6.5\text{A}, T_J = 150^\circ\text{C}$
$V_{GE(th)}$	Gate Threshold Voltage	3.0	—	5.5		$V_{CE} = V_{GE}, I_C = 250\mu\text{A}$
$\Delta V_{GE(th)}/\Delta T_J$	Temp. Coeff. of Threshold Voltage	—	-11	—	mV/°C	$V_{CE} = V_{GE}, I_C = 250\mu\text{A}$
g_{fe}	Forward Transconductance ④	1.4	4.3	—	S	$V_{CE} = 100V, I_C = 6.5\text{A}$
I_{CES}	Zero Gate Voltage Collector Current	—	—	250	μA	$V_{GE} = 0V, V_{CE} = 600V$
		—	—	1700		$V_{GE} = 0V, V_{CE} = 600V, T_J = 150^\circ\text{C}$
V_{FM}	Diode Forward Voltage Drop	—	1.4	1.7	V	$I_C = 8.0\text{A}$ See Fig. 13
		—	1.3	1.6		$I_C = 8.0\text{A}, T_J = 150^\circ\text{C}$
I_{GES}	Gate-to-Emitter Leakage Current	—	—	± 100	nA	$V_{GE} = \pm 20V$

Switching Characteristics @ $T_J = 25^\circ\text{C}$ (unless otherwise specified)

	Parameter	Min.	Typ.	Max.	Units	Conditions
Q_g	Total Gate Charge (turn-on)	—	16	22	nC	$I_C = 6.5\text{A}$ $V_{CC} = 400V$ See Fig. 8
Q_{ge}	Gate - Emitter Charge (turn-on)	—	2.5	3.8		
Q_{gc}	Gate - Collector Charge (turn-on)	—	7.8	13		
$t_{d(on)}$	Turn-On Delay Time	—	60	—	ns	$T_J = 25^\circ\text{C}$ $I_C = 6.5\text{A}, V_{CC} = 480V$ $V_{GE} = 15V, R_G = 50\Omega$ Energy losses include "tail" and diode reverse recovery. See Fig. 9, 10, 11, 18
t_r	Rise Time	—	29	—		
$t_{d(off)}$	Turn-Off Delay Time	—	130	200		
t_f	Fall Time	—	65	120		
E_{on}	Turn-On Switching Loss	—	0.21	—	mJ	$T_J = 150^\circ\text{C}$, See Fig. 9, 10, 11, 18 $I_C = 6.5\text{A}, V_{CC} = 480V$ $V_{GE} = 15V, R_G = 50\Omega$ Energy losses include "tail" and diode reverse recovery.
E_{off}	Turn-Off Switching Loss	—	0.22	—		
E_{ts}	Total Switching Loss	—	0.43	0.65		
$t_{d(on)}$	Turn-On Delay Time	—	60	—	ns	$T_J = 150^\circ\text{C}$, See Fig. 9, 10, 11, 18 $I_C = 6.5\text{A}, V_{CC} = 480V$ $V_{GE} = 15V, R_G = 50\Omega$ Energy losses include "tail" and diode reverse recovery.
t_r	Rise Time	—	30	—		
$t_{d(off)}$	Turn-Off Delay Time	—	210	—		
t_f	Fall Time	—	180	—		
E_{ts}	Total Switching Loss	—	0.71	—	mJ	
L_E	Internal Emitter Inductance	—	7.5	—	nH	Measured 5mm from package
C_{ies}	Input Capacitance	—	330	—	pF	$V_{GE} = 0V$ $V_{CC} = 30V$ See Fig. 7 $f = 1.0\text{MHz}$
C_{oes}	Output Capacitance	—	65	—		
C_{res}	Reverse Transfer Capacitance	—	6.0	—		
t_{rr}	Diode Reverse Recovery Time	—	37	55	ns	$T_J = 25^\circ\text{C}$ See Fig. 14 $T_J = 125^\circ\text{C}$ 14
		—	55	90		
I_{rr}	Diode Peak Reverse Recovery Current	—	3.5	5.0	A	$T_J = 25^\circ\text{C}$ See Fig. 15 $T_J = 125^\circ\text{C}$ 15
		—	4.5	8.0		
Q_{rr}	Diode Reverse Recovery Charge	—	65	138	nC	$T_J = 25^\circ\text{C}$ See Fig. 16 $T_J = 125^\circ\text{C}$ 16
		—	124	360		
$di_{(rec)M}/dt$	Diode Peak Rate of Fall of Recovery During t_b	—	240	—	A/ μs	$T_J = 25^\circ\text{C}$ See Fig. 17 $T_J = 125^\circ\text{C}$ 17
		—	210	—		

Notes:

- ① Repetitive rating; $V_{GE}=20V$, pulse width limited by max. junction temperature. (See fig. 20)
- ② $V_{CC}=80\%(V_{CES}), V_{GE}=20V, L=10\mu\text{H}, R_G=50\Omega$, (See fig. 19)
- ③ Pulse width $\leq 80\mu\text{s}$; duty factor $\leq 0.1\%$.
- ④ Pulse width 5.0 μs , single shot.

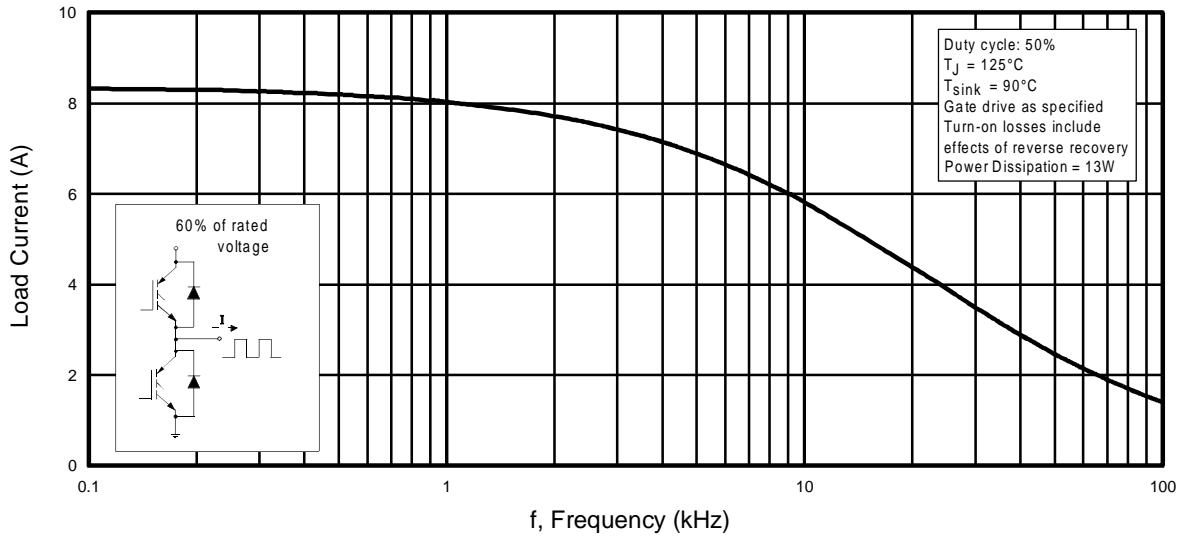

Fig. 1 - Typical Load Current vs. Frequency
(Load Current = I_{RMS} of fundamental)

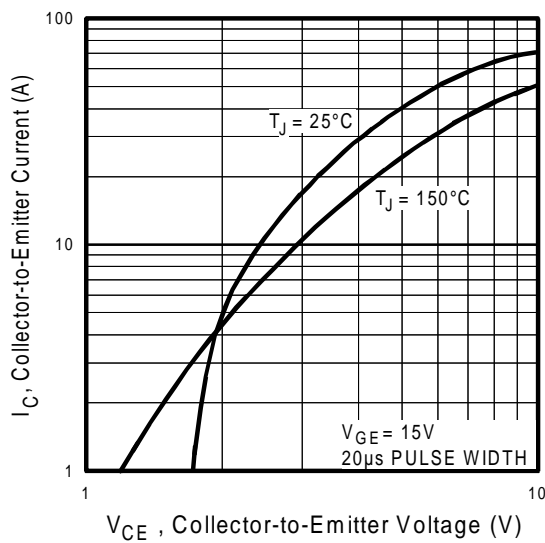

Fig. 2 - Typical Output Characteristics

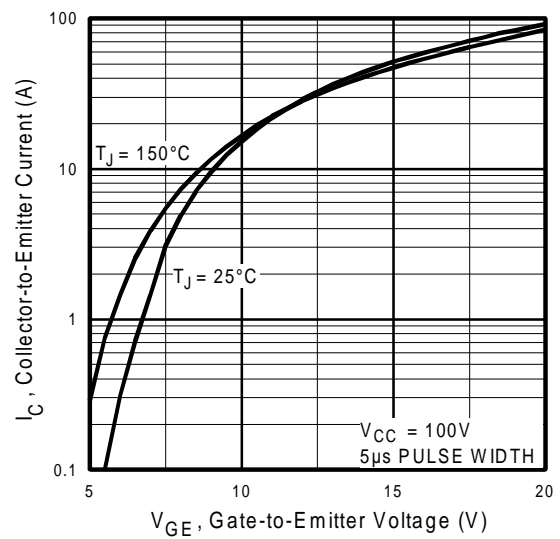

Fig. 3 - Typical Transfer Characteristics

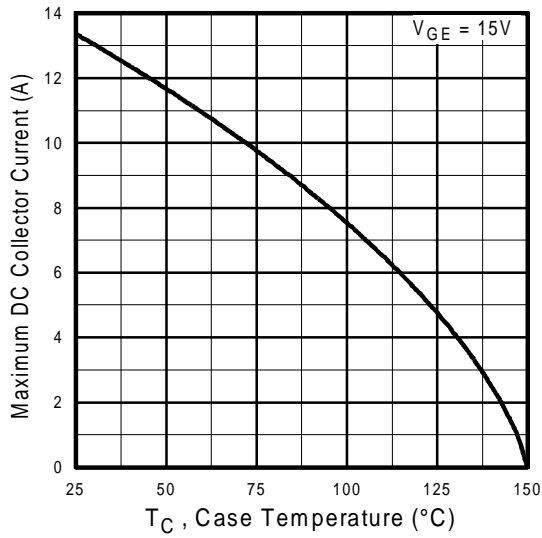

Fig. 4 - Maximum Collector Current vs. Case Temperature

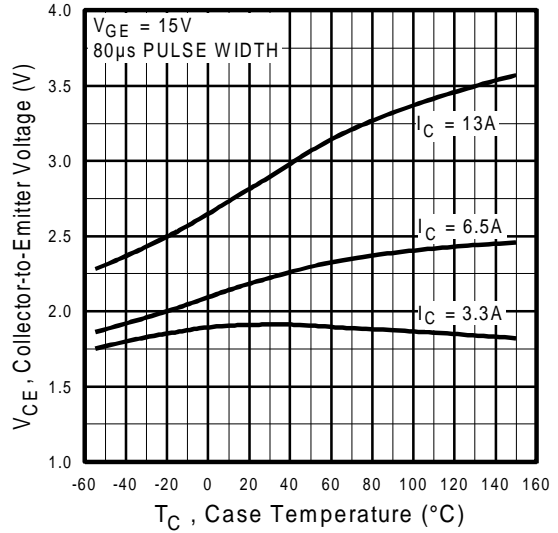

Fig. 5 - Collector-to-Emitter Voltage vs. Case Temperature

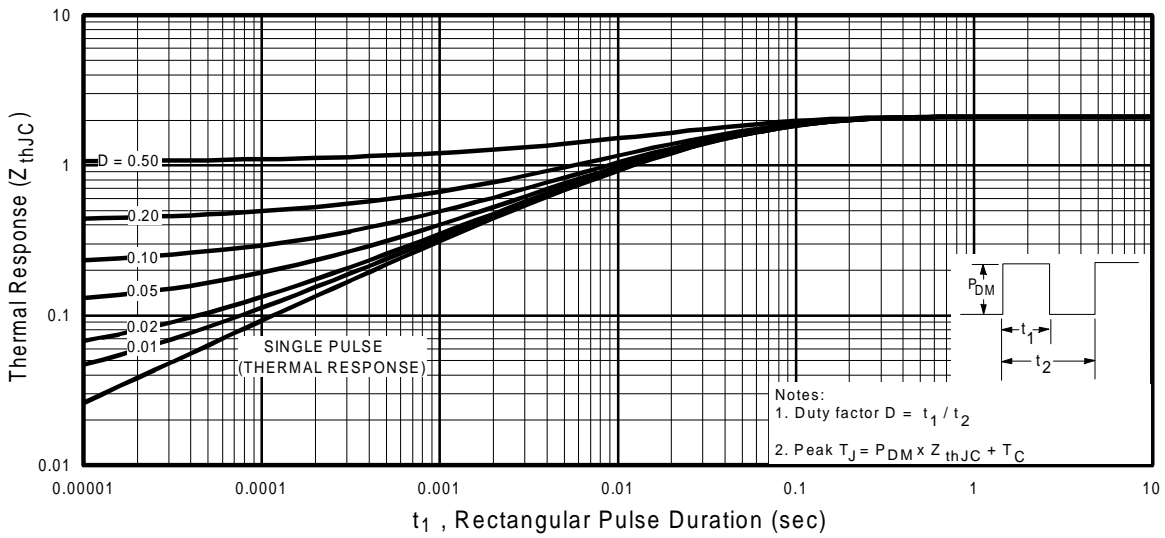

Fig. 6 - Maximum IGBT Effective Transient Thermal Impedance, Junction-to-Case

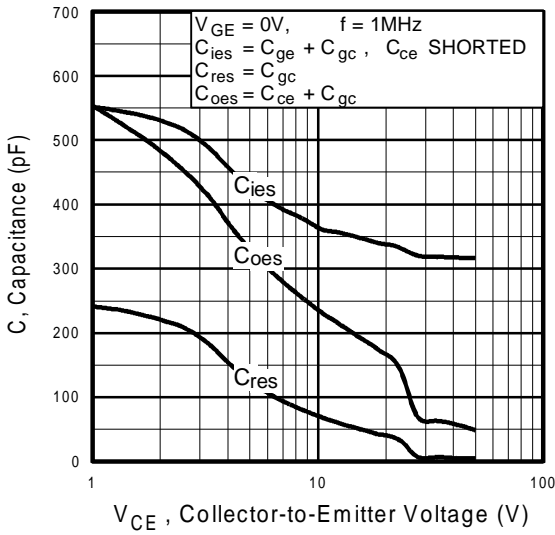

Fig. 7 - Typical Capacitance vs. Collector-to-Emitter Voltage

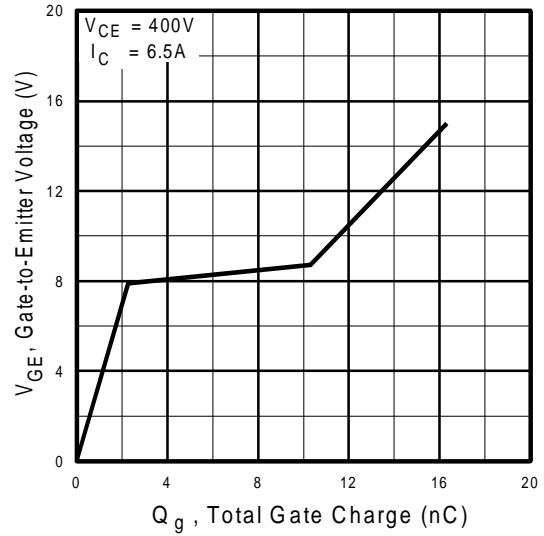

Fig. 8 - Typical Gate Charge vs. Gate-to-Emitter Voltage

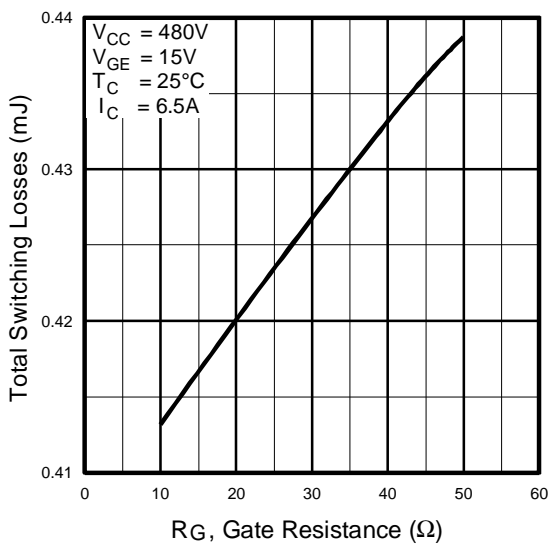

Fig. 9 - Typical Switching Losses vs. Gate Resistance

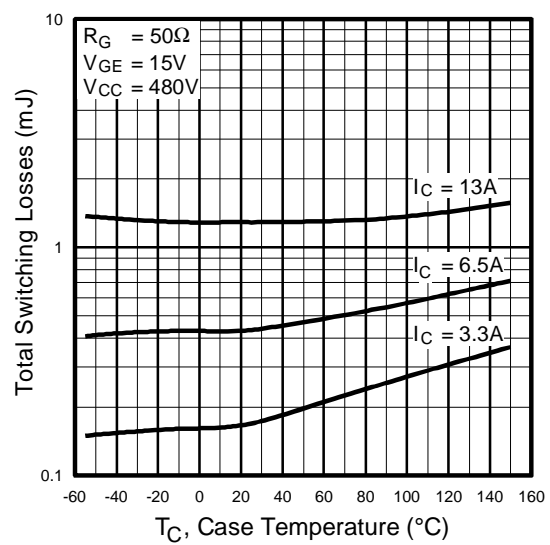

Fig. 10 - Typical Switching Losses vs. Case Temperature

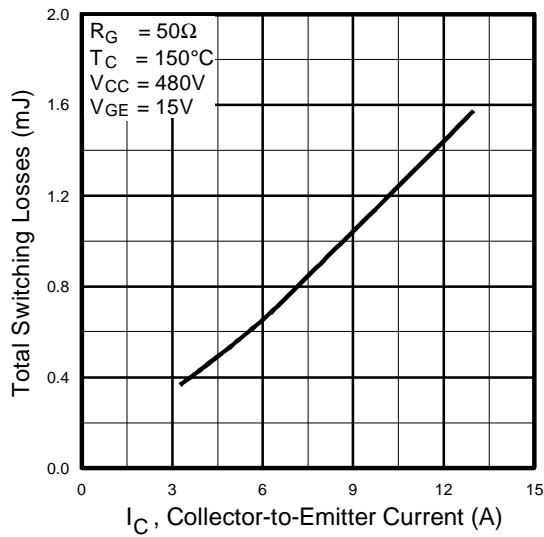

Fig. 11 - Typical Switching Losses vs. Collector-to-Emitter Current

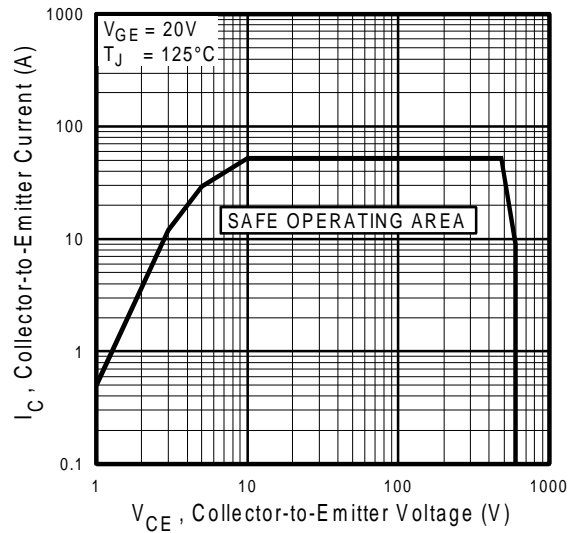

Fig. 12 - Turn-Off SOA

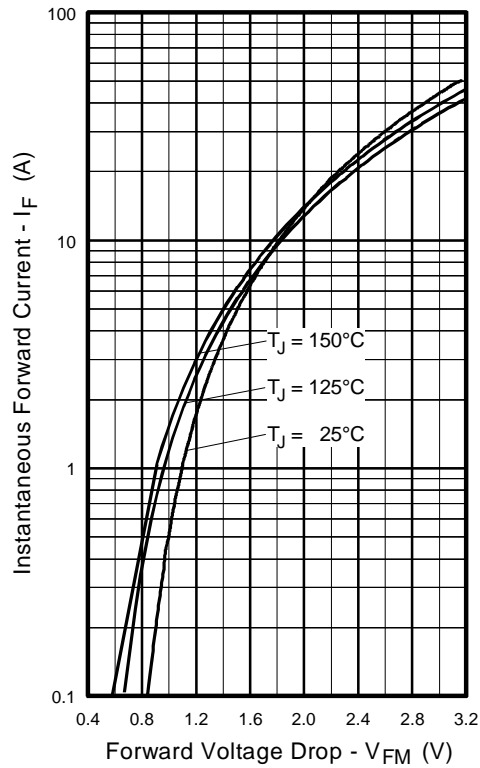

Fig. 13 - Maximum Forward Voltage Drop vs. Instantaneous Forward Current

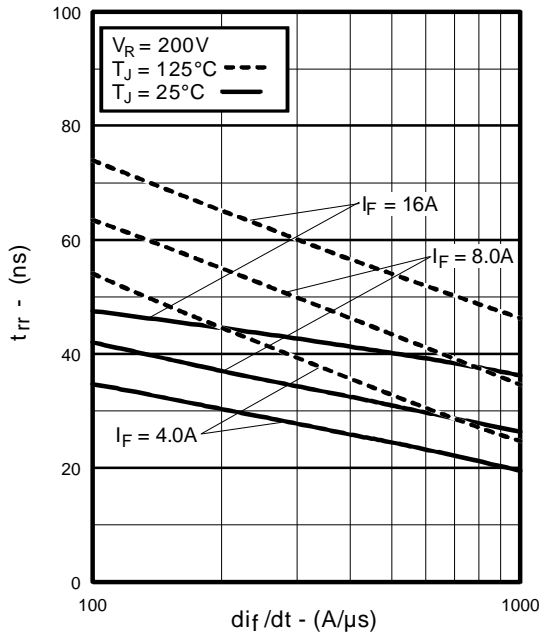

Fig. 14 - Typical Reverse Recovery vs. di_f/dt

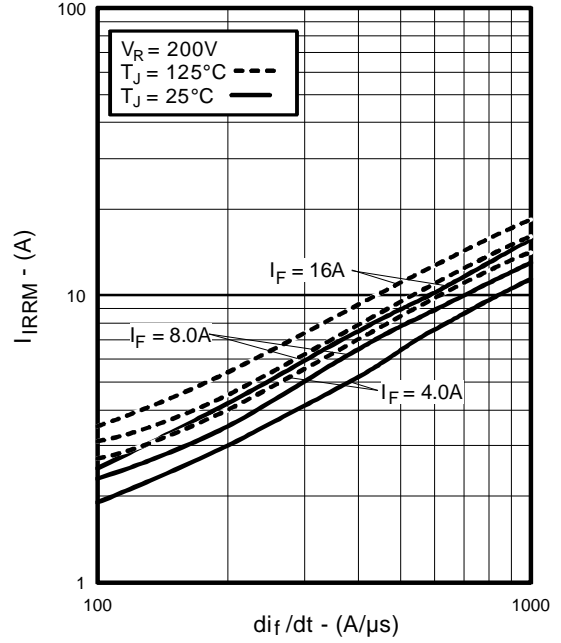

Fig. 15 - Typical Recovery Current vs. di_f/dt

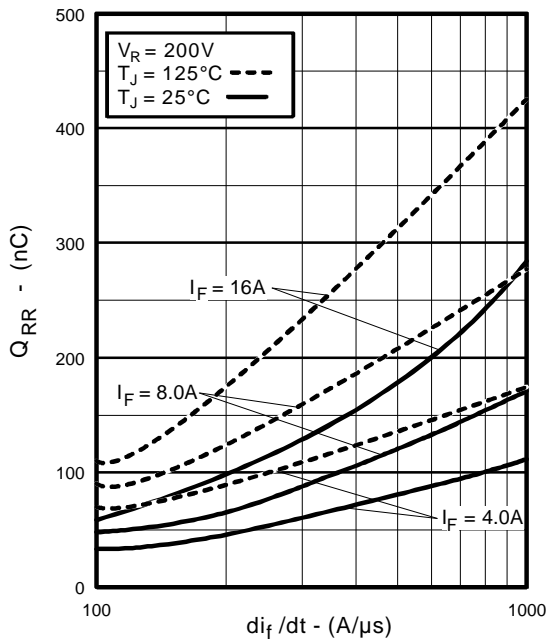

Fig. 16 - Typical Stored Charge vs. di_f/dt

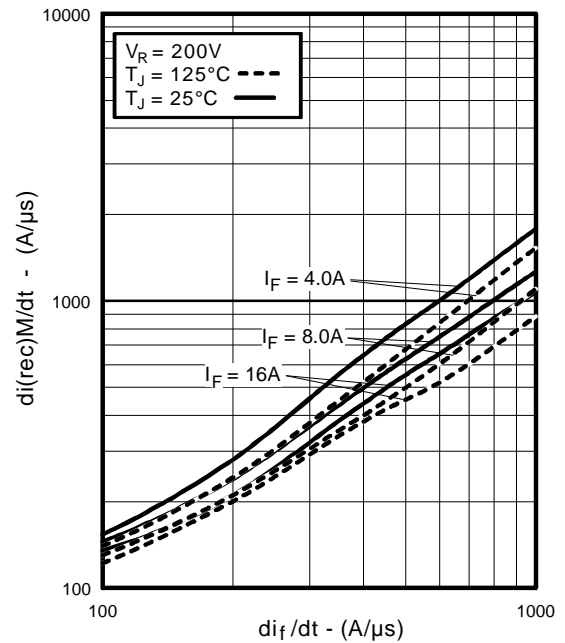

Fig. 17 - Typical $di_{(rec)M}/dt$ vs. di_f/dt

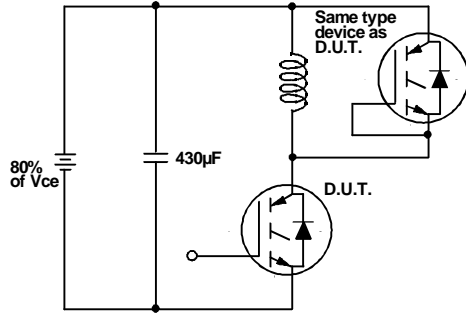

Fig. 18a - Test Circuit for Measurement of I_{LM} , E_{on} , $E_{off}(\text{diode})$, t_{rr} , Q_{rr} , I_{rr} , $t_{d(on)}$, t_r , $t_{d(off)}$, t_f

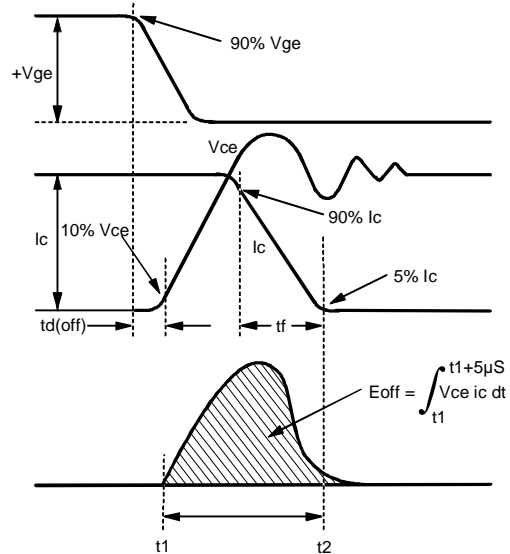

Fig. 18b - Test Waveforms for Circuit of Fig. 18a, Defining E_{off} , $t_{d(off)}$, t_f

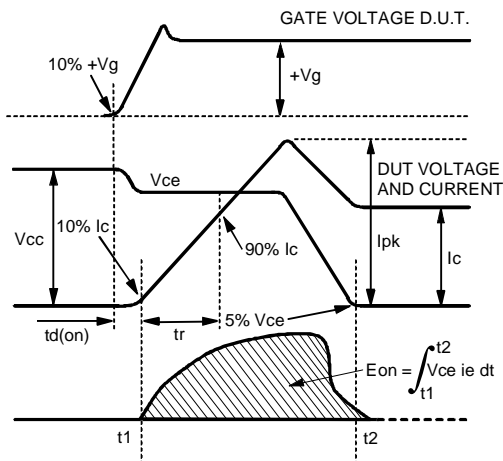

Fig. 18c - Test Waveforms for Circuit of Fig. 18a, Defining E_{on} , $t_{d(on)}$, t_r

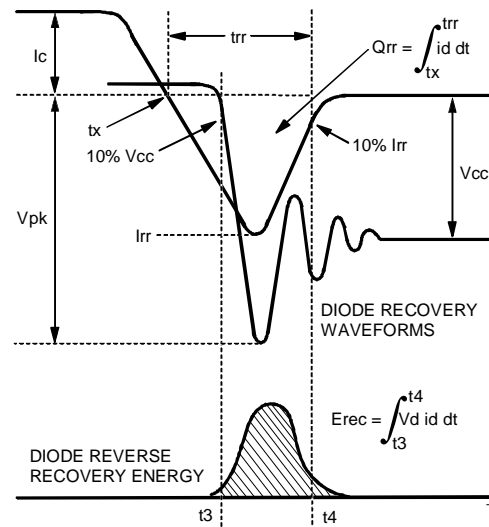

Fig. 18d - Test Waveforms for Circuit of Fig. 18a, Defining E_{rec} , t_{rr} , Q_{rr} , I_{rr}

Refer to Section D for the following:
Appendix D: Section D - page D-6

- Fig. 18e - Macro Waveforms for Test Circuit Fig. 18a
- Fig. 19 - Clamped Inductive Load Test Circuit
- Fig. 20 - Pulsed Collector Current Test Circuit