

#### 400 Volt, 1.00Ω HEXFET

HEXFET technology is the key to International Rectifier's advanced line of power MOSFET transistors. The efficient geometry achieves very low on-state resistance combined with high transconductance.

HEXFET transistors also feature all of the well-established advantages of MOSFETs, such as voltage control, very fast switching, ease of paralleling and electrical parameter temperature stability. They are well-suited for applications such as switching power supplies, motor controls, inverters, choppers, audio amplifiers, and high energy pulse circuits, and virtually any application where high reliability is required.

#### Product Summary

Part Number	BV <sub>DSS</sub>	R <sub>DSON</sub>	I <sub>D</sub>
JANTX2N6760	400V	1.00Ω	5.5A
JANTXV2N6760			

#### Features:

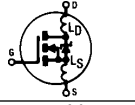
- Avalanche Energy Rating
- Dynamic dv/dt Rating
- Simple Drive Requirements
- Ease of Paralleling
- Hermetically Sealed

#### Absolute Maximum Ratings

	Parameter	JANTX2N6760, JANTXV2N6760	Units
I <sub>D</sub> @ V <sub>GS</sub> = 10V, T <sub>C</sub> = 25°C	Continuous Drain Current	5.5	A
I <sub>D</sub> @ V <sub>GS</sub> = 10V, T <sub>C</sub> = 100°C	Continuous Drain Current	3.5	
I <sub>DM</sub>	Pulsed Drain Current ①	22	
P <sub>D</sub> @ T <sub>C</sub> = 25°C	Max. Power Dissipation	75	W
	Linear Derating Factor	0.60	W/K ⑤
V <sub>GS</sub>	Gate-to-Source Voltage	±20	V
E <sub>AS</sub>	Single Pulse Avalanche Energy ②	1.7	mJ
I <sub>AR</sub>	Avalanche Current ①	5.5	A
E <sub>AR</sub>	Repetitive Avalanche Energy ①	—	mJ
dv/dt	Peak Diode Recovery dv/dt ③	4.0	V/ns
T <sub>J</sub>	Operating Junction	-55 to 150	°C
T <sub>STG</sub>	Storage Temperature Range		
	Lead Temperature	300 (0.063 in. (1.6mm) from case for 10.5 seconds)	
	Weight	11.5 (typical)	

# JANTX2N6760, JANTXV2N6760 Device

## Electrical Characteristics @ Tj = 25°C (Unless Otherwise Specified)

	Parameter	Min.	Typ.	Max.	Units	Test Conditions
$BV_{DSS}$	Drain-to-Source Breakdown Voltage	400	—	—	V	$V_{GS} = 0V, I_D = 1.0 \text{ mA}$
$\Delta BV_{DSS}/\Delta T_J$	Temperature Coefficient of Breakdown Voltage	—	0.46	—	V/°C	Reference to 25°C, $I_D = 1.0 \text{ mA}$
RDS(on)	Static Drain-to-Source	—	—	1.00	$\Omega$	$V_{GS} = 10V, I_D = 3.5A \text{ ④}$
	On-State Resistance	—	—	1.22		
$V_{GS(th)}$	Gate Threshold Voltage	2.0	—	4.0	V	$V_{DS} = V_{GS}, I_D = 250\mu A$
$g_{fs}$	Forward Transconductance	2.9	—	—	S (r)	$V_{DS} > 15V, I_{DS} = 3.5A \text{ ④}$
IDSS	Zero Gate Voltage Drain Current	—	—	25	$\mu A$	$V_{DS} = 0.8 \times \text{Max Rating}, V_{GS} = 0V$
		—	—	250		
IGSS	Gate-to-Source Leakage Forward	—	—	100	nA	$V_{GS} = 20V$
IGSS	Gate-to-Source Leakage Reverse	—	—	-100	nA	$V_{GS} = -20V$
$Q_g$	Total Gate Charge	17	—	39	nC	$V_{GS} = 10V, I_D = 5.5A$ $V_{DS} = \text{Max. Rating} \times 0.5$ see figures 6 and 13
$Q_{gs}$	Gate-to-Source Charge	2.0	—	6.0		
$Q_{gd}$	Gate-to-Drain ("Miller") Charge	8.0	—	20		
$t_{d(on)}$	Turn-On Delay Time	—	—	30	ns	$V_{DD} = 200V, I_D = 5.5A,$ $R_G = 7.5\Omega, V_{GS} = 10V$  see figure 10
$t_r$	Rise Time	—	—	40		
$t_{d(off)}$	Turn-Off Delay Time	—	—	80		
$t_f$	Fall Time	—	—	35		
LD	Internal Drain Inductance	—	5.0	—	nH	<p>Measured from the drain lead, 6mm (0.25 in.) from package to center of die.</p> <p>Modified MOSFET symbol showing the internal inductances.</p> 
LS	Internal Source Inductance	—	13.0	—		
$C_{iss}$	Input Capacitance	—	620	—	pF	$V_{GS} = 0V, V_{DS} = 25V$ $f = 1.0 \text{ MHz}$ see figure 5
$C_{oss}$	Output Capacitance	—	200	—		
$C_{rss}$	Reverse Transfer Capacitance	—	75	—		

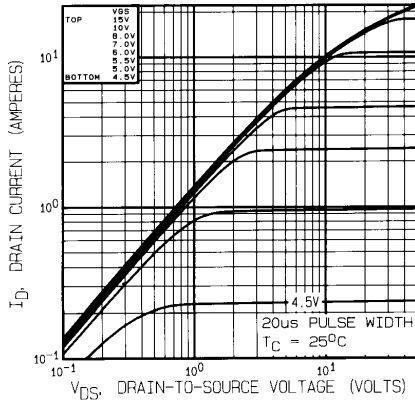
## Source-Drain Diode Ratings and Characteristics

	Parameter	Min.	Typ.	Max.	Units	Test Conditions
$I_S$	Continuous Source Current (Body Diode)	—	—	5.5	A	Modified MOSFET symbol showing the integral reverse p-n junction rectifier.
$I_{SM}$	Pulse Source Current (Body Diode) ①	—	—	22		
$V_{SD}$	Diode Forward Voltage	—	—	1.5	V	$T_j = 25^\circ C, I_S = 5.5A, V_{GS} = 0V \text{ ④}$
$t_{rr}$	Reverse Recovery Time	—	—	700	ns	$T_j = 25^\circ C, I_F = 5.5A, di/dt \leq 100A/\mu s$ $V_{DD} \leq 50V \text{ ④}$
$Q_{RR}$	Reverse Recovery Charge	—	—	6.2	$\mu C$	
$t_{on}$	Forward Turn-On Time	Intrinsic turn-on time is negligible. Turn-on speed is substantially controlled by $L_S + L_D$ .				

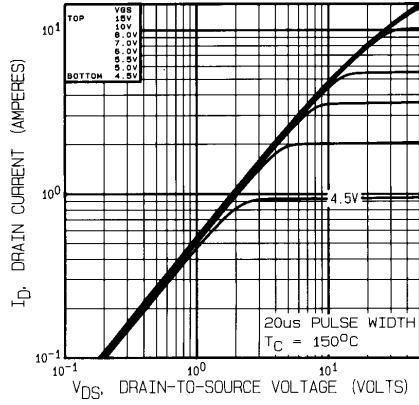
## Thermal Resistance

	Parameter	Min.	Typ.	Max.	Units	Test Conditions
$R_{thJC}$	Junction-to-Case	—	—	1.67	K/W	Typical socket mount
$R_{thJA}$	Junction-to-Ambient	—	—	30		

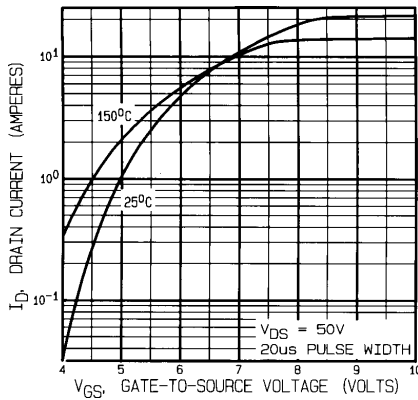
# JANTX2N6760, JANTXV2N6760 Device



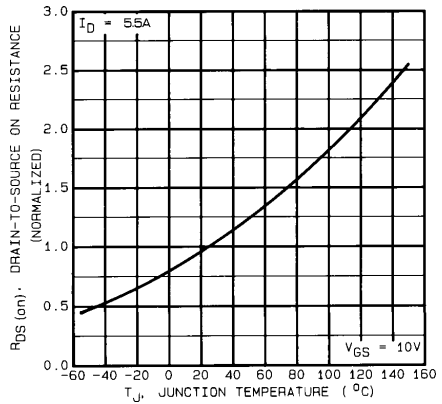
**Fig. 1 — Typical Output Characteristics**  
 $T_C = 25^\circ\text{C}$



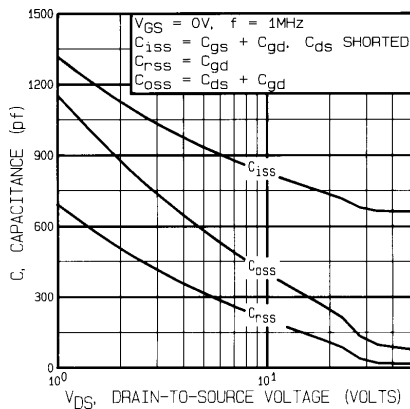
**Fig. 2 — Typical Output Characteristics**  
 $T_C = 150^\circ\text{C}$



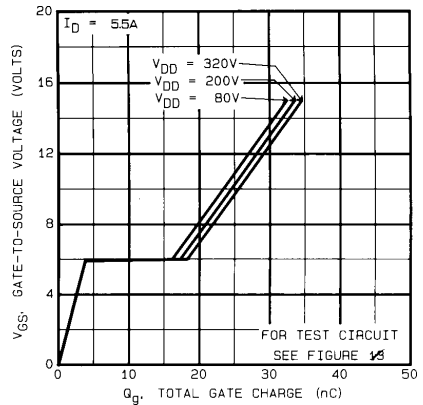
**Fig. 3 — Typical Transfer Characteristics**



**Fig. 4 — Normalized On-Resistance Vs. Temperature**

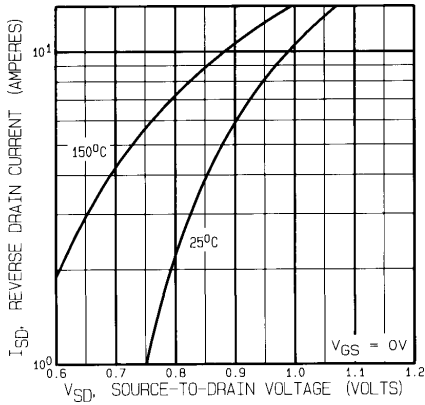


**Fig. 5 — Typical Capacitance Vs. Drain-to-Source Voltage**

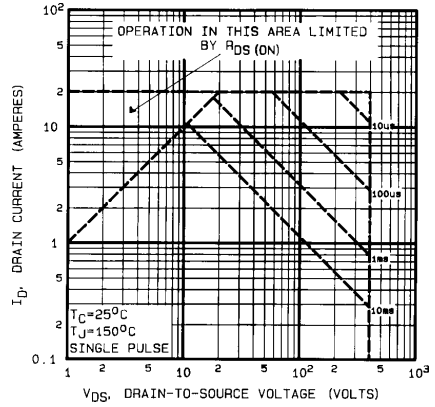


**Fig. 6 — Typical Gate Charge Vs. Gate-to-Source Voltage**

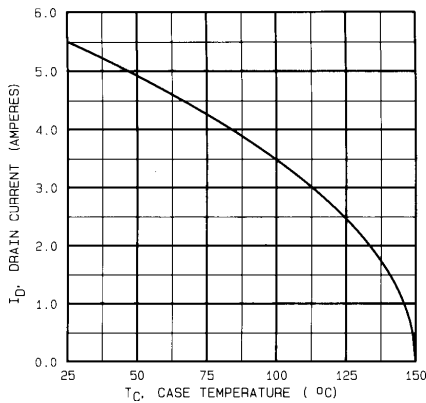
# JANTX2N6760, JANTXV2N6760 Device



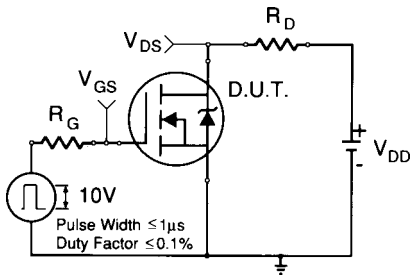
**Fig. 7 — Typical Source-to-Drain Diode Forward Voltage**



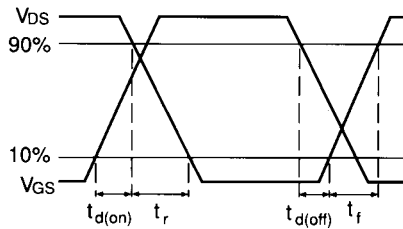
**Fig. 8 — Maximum Safe Operating Area**



**Fig. 9 — Maximum Drain Current Vs. Case Temperature**



**Fig. 10a — Switching Time Test Circuit**



**Fig. 10b — Switching Time Waveforms**

# JANTX2N6760, JANTXV2N6760 Device

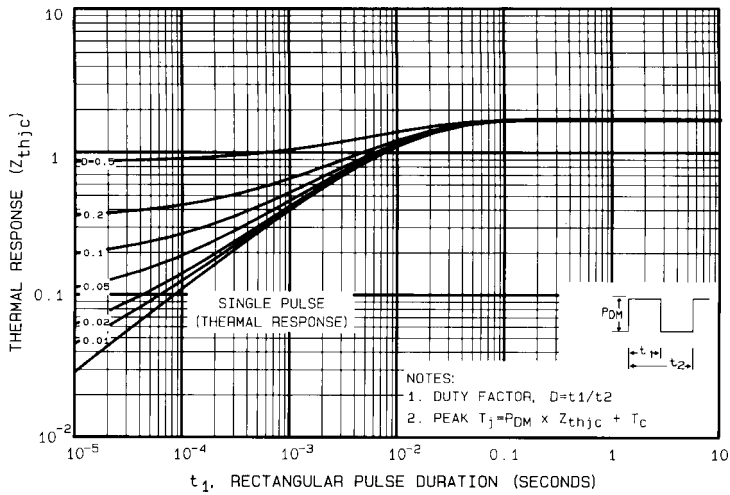


Fig. 11 — Maximum Effective Transient Thermal Impedance, Junction-to-Case Vs. Pulse Duration

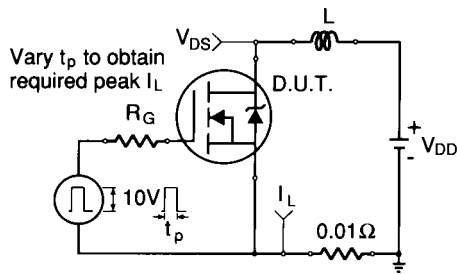


Fig. 12a — Unclamped Inductive Test Circuit

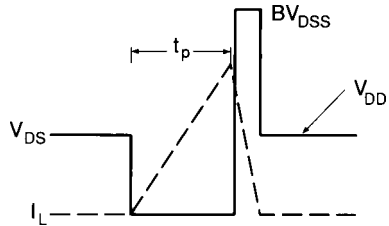


Fig. 12b — Unclamped Inductive Waveforms

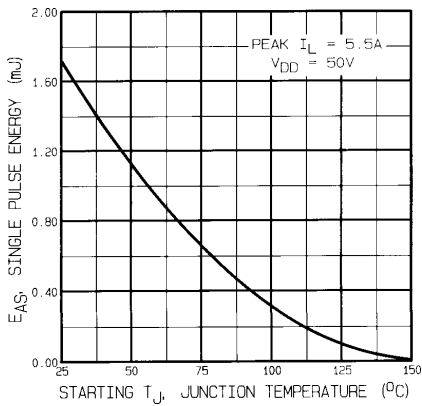


Fig. 12c — Max. Avalanche Energy vs. Current

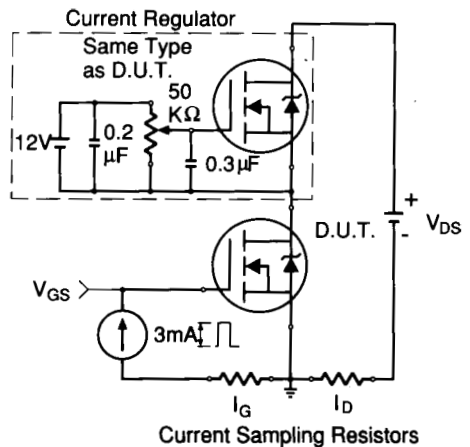


Fig. 13a — Gate Charge Test Circuit

# JANTX2N6760, JANTXV2N6760 Device

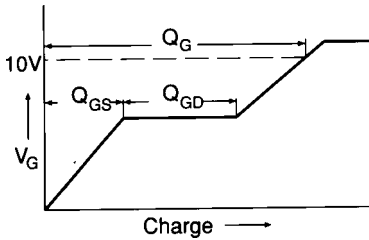
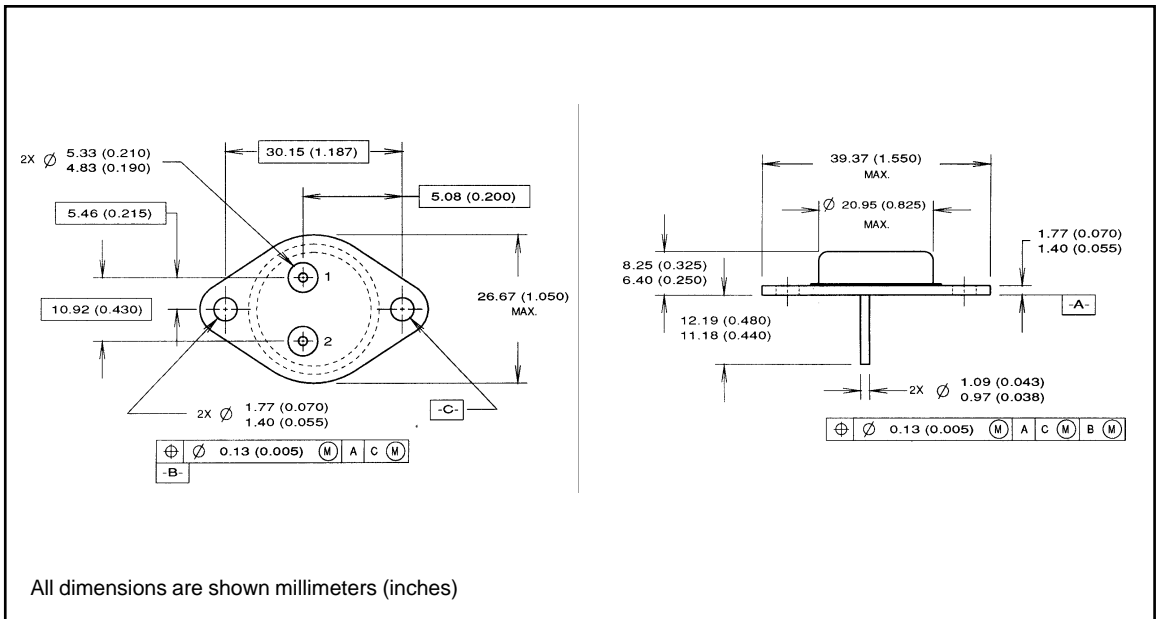


Fig. 13b — Basic Gate Charge Waveform

- ① Repetitive Rating; Pulse width limited by maximum junction temperature. (see figure 11)
- ② @  $V_{DD} = 50V$ , Starting  $T_J = 25^\circ C$ ,  
 $EAS = [0.5 * L * (I_L^2) * [BV_{DSS}/(BV_{DSS}-V_{DD})]$   
 Peak  $I_L = 5.5A$ ,  $V_{GS} = 10V$ ,  $25 \leq R_G \leq 200\Omega$
- ③  $I_{SD} \leq 5.5A$ ,  $di/dt \leq 90A/\mu s$ ,  
 $V_{DD} \leq BV_{DSS}$ ,  $T_J \leq 150^\circ C$
- ④ Pulse width  $\leq 300 \mu s$ ; Duty Cycle  $\leq 2\%$
- ⑤  $K/W = ^\circ C/W$   
 $W/K = W/^\circ C$

## Case Outline and Dimensions — TO-204AA (Modified TO-3)



# International IR Rectifier

**WORLD HEADQUARTERS:** 233 Kansas St., El Segundo, California 90245, Tel: (310) 322 3331

**EUROPEAN HEADQUARTERS:** Hurst Green, Oxted, Surrey RH8 9BB, UK Tel: ++ 44 1883 732020

**IR CANADA:** 7321 Victoria Park Ave., Suite 201, Markham, Ontario L3R 2Z8, Tel: (905) 475 1897

**IR GERMANY:** Saalburgstrasse 157, 61350 Bad Homburg Tel: ++ 49 6172 96590

**IR ITALY:** Via Liguria 49, 10071 Borgaro, Torino Tel: ++ 39 11 451 0111

**IR FAR EAST:** K&H Bldg., 2F, 3-30-4 Nishi-Ikeburo 3-Chome, Toshima-Ki, Tokyo Japan 171 Tel: 81 3 3983 0086

**IR SOUTHEAST ASIA:** 315 Outram Road, #10-02 Tan Boon Liat Building, Singapore 0316 Tel: 65 221 8371

<http://www.irf.com/> Data and specifications subject to change without notice. 10/96