

-200 Volt, 0.80Ω HEXFET

HEXFET technology is the key to International Rectifier's advanced line of power MOSFET transistors. The efficient geometry achieves very low on-state resistance combined with high transconductance.

HEXFET transistors also feature all of the well-established advantages of MOSFETs, such as voltage control, very fast switching, ease of paralleling and electrical parameter temperature stability. They are well-suited for applications such as switching power supplies, motor controls, inverters, choppers, audio amplifiers, and high energy pulse circuits, and virtually any application where high reliability is required.

Product Summary

Part Number	BV _{DSS}	R _{Ds(on)}	I _D
JANTX2N6806	-200V	0.80Ω	-6.5A
JANTXV2N6806			

Features:

- Avalanche Energy Rating
- Dynamic dv/dt Rating
- Simple Drive Requirements
- Ease of Paralleling
- Hermetically Sealed

Absolute Maximum Ratings

	Parameter	JANTX2N6806, JANTXV2N6806	Units
I _D @ V _{GS} = -10V, T _C = 25°C	Continuous Drain Current	-6.5	A
I _D @ V _{GS} = -10V, T _C = 100°C	Continuous Drain Current	-4.0	
I _{DM}	Pulsed Drain Current ①	-28	
P _D @ T _C = 25°C	Max. Power Dissipation	75	W
	Linear Derating Factor	0.60	W/K ⑤
V _{GS}	Gate-to-Source Voltage	±20	V
E _{AS}	Single Pulse Avalanche Energy ②	66	mJ
I _{AR}	Avalanche Current ①	-6.5	A
E _{AR}	Repetitive Avalanche Energy ①	7.5	mJ
dv/dt	Peak Diode Recovery dv/dt ③	-5.0	V/ns
T _J	Operating Junction	-55 to 150	°C
T _{STG}	Storage Temperature Range		
	Lead Temperature	300 (0.063 in. (1.6mm) from case for 10.5 seconds)	
	Weight	11.5 (typical)	

JANTX2N6806, JANTXV2N6806 Device

Electrical Characteristics @ T_j = 25°C (Unless Otherwise Specified)

	Parameter	Min.	Typ.	Max.	Units	Test Conditions
BV _{DSS}	Drain-to-Source Breakdown Voltage	-200	—	—	V	V _{GS} = 0V, I _D = -1.0 mA
ΔBV _{DSS} /ΔT _J	Temperature Coefficient of Breakdown Voltage	—	-0.20	—	V/°C	Reference to 25°C, I _D = -1.0 mA
RDS(on)	Static Drain-to-Source	—	—	0.80	Ω	V _{GS} = -10V, I _D = -4.0A ^④
	On-State Resistance	—	—	0.92		V _{GS} = -10V, I _D = -6.5A
VGS(th)	Gate Threshold Voltage	-2.0	—	-4.0	V	V _{DS} = V _{GS} , I _D = -250μA
g _{fs}	Forward Transconductance	2.0	—	—	S (r)	V _{DS} > -15V, I _{DS} = -4.0A ^④
IDSS	Zero Gate Voltage Drain Current	—	—	-25	μA	V _{DS} = 0.8 x Max Rating, V _{GS} = 0V
		—	—	-250		V _{DS} = 0.8 x Max Rating V _{GS} = 0V, T _J = 125°C
IGSS	Gate-to-Source Leakage Forward	—	—	-100	nA	V _{GS} = -20V
IGSS	Gate-to-Source Leakage Reverse	—	—	100	nA	V _{GS} = 20V
Q _g	Total Gate Charge	8	—	31	nC	V _{GS} = -10V, I _D = -6.5A
Q _{gs}	Gate-to-Source Charge	0.8	—	7.0		V _{DS} = Max. Rating x 0.5
Q _{gd}	Gate-to-Drain ("Miller") Charge	5.0	—	17		see figures 6 and 13
t _{d(on)}	Turn-On Delay Time	—	—	50	ns	V _{DD} = -100V, I _D = -6.5A, R _G = 7.5Ω, V _{GS} = -10V
t _r	Rise Time	—	—	100		
t _{d(off)}	Turn-Off Delay Time	—	—	100		
t _f	Fall Time	—	—	80		
LD	Internal Drain Inductance	—	5.0	—	nH	Measured from the drain lead, 6mm (0.25 in.) from package to center of die.
LS	Internal Source Inductance	—	13.0	—		Measured from the source lead, 6mm (0.25 in.) from package to source bonding pad.
C _{iss}	Input Capacitance	—	700	—	pF	V _{GS} = 0V, V _{DS} = -25V f = 1.0 MHz see figure 5
C _{oss}	Output Capacitance	—	200	—		
C _{rss}	Reverse Transfer Capacitance	—	40	—		

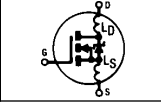

Source-Drain Diode Ratings and Characteristics

	Parameter	Min.	Typ.	Max.	Units	Test Conditions
I _S	Continuous Source Current (Body Diode)	—	—	-6.5	A	Modified MOSFET symbol showing the integral reverse p-n junction rectifier.
I _{SM}	Pulse Source Current (Body Diode) ^①	—	—	-28		
V _{SD}	Diode Forward Voltage	—	—	-6.0	V	T _j = 25°C, I _S = -6.5A, V _{GS} = 0V ^④
t _{rr}	Reverse Recovery Time	—	—	400	ns	T _j = 25°C, I _F = -6.5A, di/dt ≤ -100A/μs V _{DD} ≤ -50V ^④
Q _{RR}	Reverse Recovery Charge	—	—	4.0	μC	
t _{on}	Forward Turn-On Time	Intrinsic turn-on time is negligible. Turn-on speed is substantially controlled by L _S + L _D .				

Thermal Resistance

	Parameter	Min.	Typ.	Max.	Units	Test Conditions
R _{thJC}	Junction-to-Case	—	—	1.67	K/W	Typical socket mount
R _{thJA}	Junction-to-Ambient	—	—	30		

JANTX2N6806, JANTXV2N6806 Device

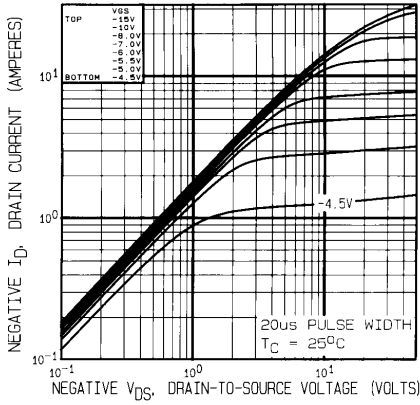

Fig. 1 — Typical Output Characteristics
 $T_C = 25^\circ\text{C}$

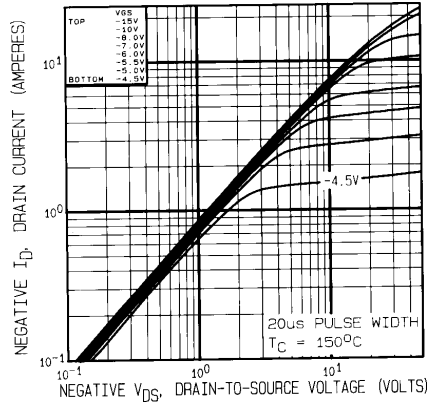

Fig. 2 — Typical Output Characteristics
 $T_C = 150^\circ\text{C}$

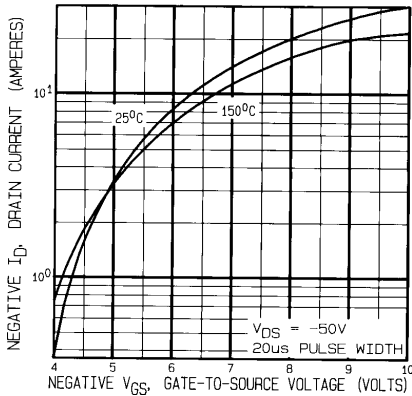

Fig. 3 — Typical Transfer Characteristics

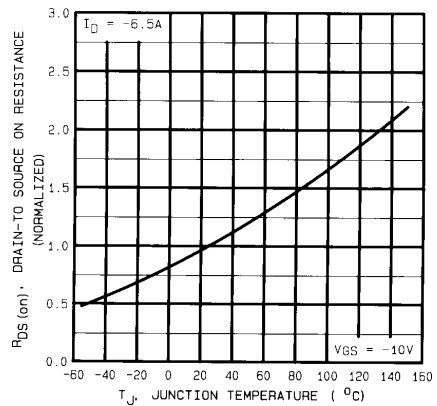

Fig. 4 — Normalized On-Resistance Vs. Temperature

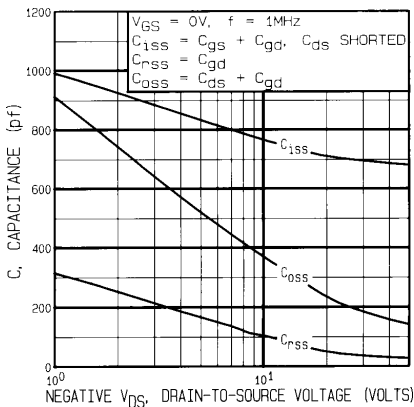

Fig. 5 — Typical Capacitance Vs. Drain-to-Source Voltage

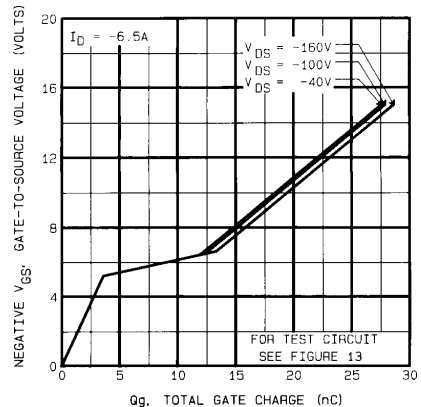

Fig. 6 — Typical Gate Charge Vs. Gate-to-Source Voltage

JANTX2N6806, JANTXV2N6806 Device

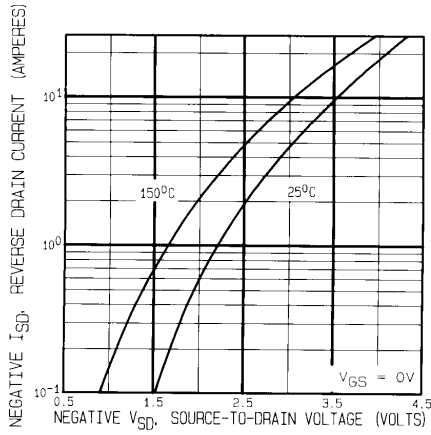

Fig. 7 — Typical Source-to-Drain Diode Forward Voltage

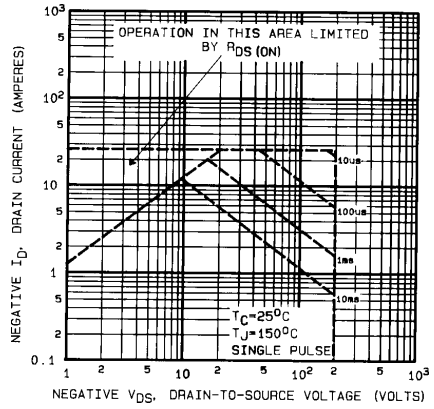

Fig. 8 — Maximum Safe Operating Area

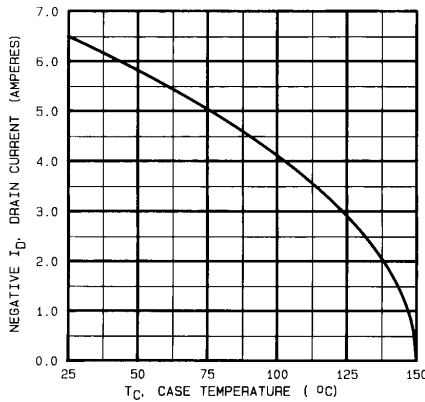

Fig. 9 — Maximum Drain Current Vs. Case Temperature

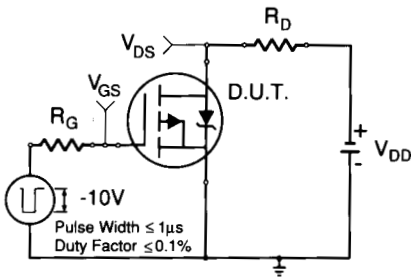

Fig. 10a — Switching Time Test Circuit

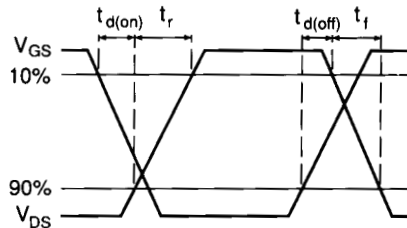

Fig. 10b — Switching Time Waveforms

JANTX2N6806, JANTXV2N6806 Device

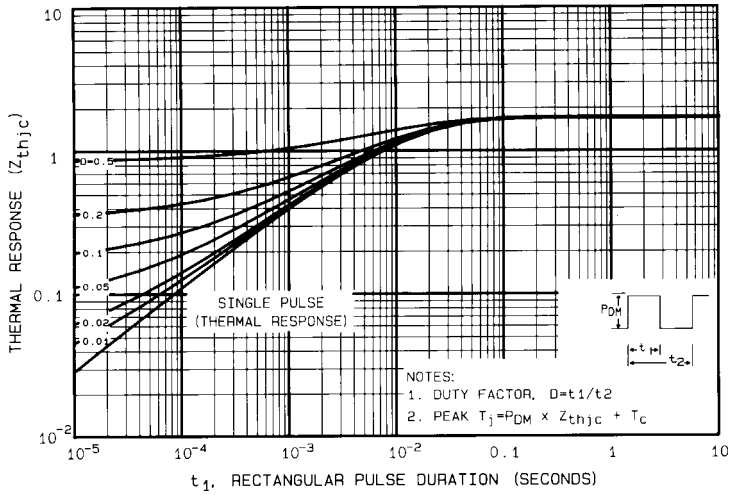

Fig. 11 — Maximum Effective Transient Thermal Impedance, Junction-to-Case Vs. Pulse Duration

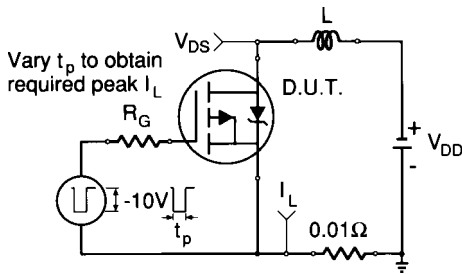

Fig. 12a — Unclamped Inductive Test Circuit

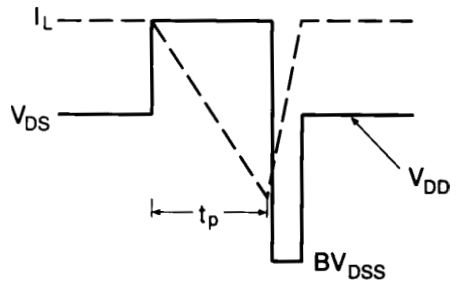

Fig. 12b — Unclamped Inductive Waveforms

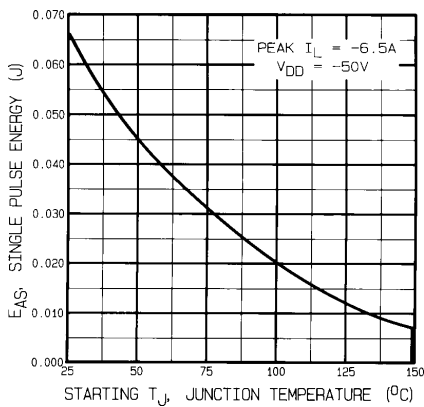

Fig. 12c — Max. Avalanche Energy vs. Current

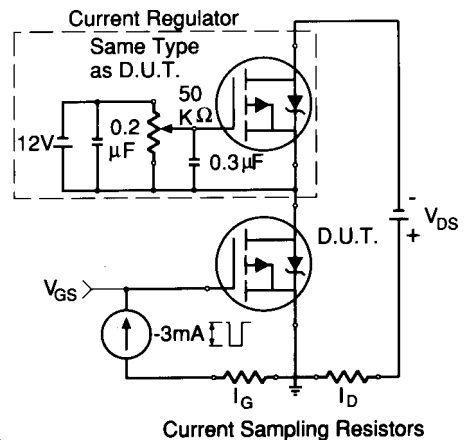

Fig. 13a — Gate Charge Test Circuit

JANTX2N6806, JANTXV2N6806 Device

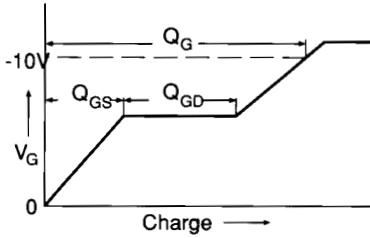
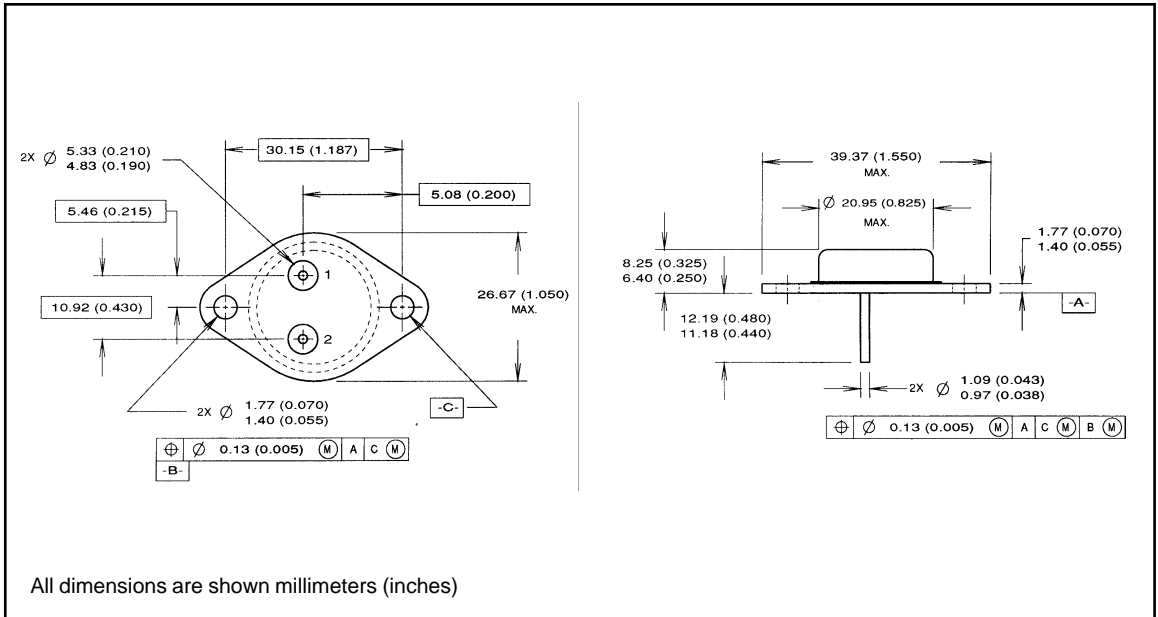

Fig. 13b — Basic Gate Charge Waveform

- ① Repetitive Rating; Pulse width limited by maximum junction temperature. (see figure 11)
- ② @ $V_{DD} = -50V$, Starting $T_J = 25^\circ C$,
 $EAS = [0.5 * L * (I_L^2) * [BV_{DSS}/(BV_{DSS}-V_{DD})]$
 Peak $I_L = -6.5A$, $V_{GS} = -10V$, $25 \leq R_G \leq 200\Omega$
- ③ $I_{SD} \leq -6.5A$, $di/dt \leq -120A/\mu s$,
 $V_{DD} \leq BV_{DSS}$, $T_J \leq 150^\circ C$
- ④ Pulse width $\leq 300 \mu s$; Duty Cycle $\leq 2\%$
- ⑤ $K/W = ^\circ C/W$
 $W/K = W/^\circ C$

Case Outline and Dimensions — TO-204AA (Modified TO-3)



International
IR Rectifier

WORLD HEADQUARTERS: 233 Kansas St., El Segundo, California 90245, Tel: (310) 322 3331

EUROPEAN HEADQUARTERS: Hurst Green, Oxted, Surrey RH8 9BB, UK Tel: ++ 44 1883 732020

IR CANADA: 7321 Victoria Park Ave., Suite 201, Markham, Ontario L3R 2Z8, Tel: (905) 475 1897

IR GERMANY: Saalburgstrasse 157, 61350 Bad Homburg Tel: ++ 49 6172 96590

IR ITALY: Via Liguria 49, 10071 Borgaro, Torino Tel: ++ 39 11 451 0111

IR FAR EAST: K&H Bldg., 2F, 3-30-4 Nishi-Ikeburo 3-Chome, Toshima-Ki, Tokyo Japan 171 Tel: 81 3 3983 0086

IR SOUTHEAST ASIA: 315 Outram Road, #10-02 Tan Boon Liat Building, Singapore 0316 Tel: 65 221 8371

<http://www.irf.com/>

Data and specifications subject to change without notice.

10/96