

HEXFET® Power MOSFET

- Isolated Package
- High Voltage Isolation = 2.5KVRMS^⑤
- Sink to Lead Creepage Dist. 4.8mm
- Logic-Level Gate Drive
- $R_{DS(ON)}$ Specified at $V_{GS} = 4V$ & $5V$
- Fast Switching
- Ease of paralleling

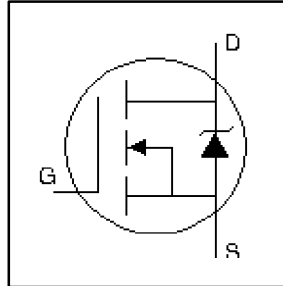

$$V_{DSS} = 200V$$

$$R_{DS(on)} = 0.80\Omega$$

$$I_D = 4.0A$$

Description

Third Generation HEXFETs from International Rectifier provide the designer with the best combination of fast switching, ruggedized device design, low on-resistance and cost-effectiveness.

The TO-220 Fullpak eliminates the need for additional insulating hardware in commercial-industrial applications. The moulding compound used provides a high isolation capability and a low thermal resistance between the tab and external heatsink. This isolation is equivalent to using a 100 micron mica barrier with standard TO-220 product. The Fullpak is mounted to a heatsink using a single clip or by a single screw fixing.

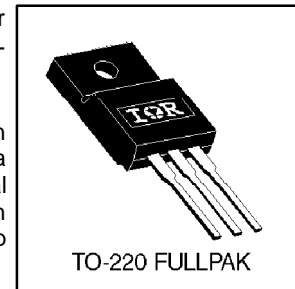

Absolute Maximum Ratings

	Parameter	Max.	Units
I_D @ $T_C = 25^\circ C$	Continuous Drain Current, V_{GS} @ 5.0V	4.0	A
I_D @ $T_C = 100^\circ C$	Continuous Drain Current, V_{GS} @ 5.0V	2.6	
I_{DM}	Pulsed Drain Current ①	16	
P_D @ $T_C = 25^\circ C$	Power Dissipation	30	W
	Linear Derating Factor	0.24	W/°C
V_{GS}	Gate-to-Source Voltage	±10	V
E_{AS}	Single Pulse Avalanche Energy ②	62	mJ
I_{AR}	Avalanche Current ③	4.0	A
E_{AR}	Repetitive Avalanche Energy ③	3.0	mJ
dv/dt	Peak Diode Recovery dv/dt ③	5.0	V/ns
T_J	Operating Junction and	-55 to + 150	°C
T_{STG}	Storage Temperature Range		
	Soldering Temperature, for 10 seconds		
	Mounting torque, 6-32 or M3 screw.	10 lbf•in (1.1N•m)	

Thermal Resistance

	Parameter	Min.	Typ.	Max.	Units
$R_{\theta JC}$	Junction-to-Case	—	—	4.1	°C/W
$R_{\theta JA}$	Junction-to-Ambient	—	—	65	

Electrical Characteristics @ $T_J = 25^\circ\text{C}$ (unless otherwise specified)

	Parameter	Min.	Typ.	Max.	Units	Conditions
$V_{(BR)DSS}$	Drain-to-Source Breakdown Voltage	200	—	—	V	$V_{GS} = 0V, I_D = 250\mu A$
$\Delta V_{(BR)DSS}/\Delta T_J$	Breakdown Voltage Temp. Coefficient	—	0.27	—	V/ $^\circ\text{C}$	Reference to $25^\circ\text{C}, I_D = 1\text{mA}$
$R_{DS(ON)}$	Static Drain-to-Source On-Resistance	—	—	0.80	Ω	$V_{GS} = 5.0V, I_D = 2.4A$ ④
		—	—	1.0		$V_{GS} = 4.0V, I_D = 2.0A$ ④
$V_{GS(th)}$	Gate Threshold Voltage	1.0	—	2.0	V	$V_{DS} = V_{GS}, I_D = 250\mu A$
g_{fs}	Forward Transconductance	1.2	—	—	S	$V_{DS} = 50V, I_D = 3.1A$
I_{DSS}	Drain-to-Source Leakage Current	—	—	25	μA	$V_{DS} = 200V, V_{GS} = 0V$
		—	—	250		$V_{DS} = 160V, V_{GS} = 0V, T_J = 125^\circ\text{C}$
I_{GSS}	Gate-to-Source Forward Leakage	—	—	100	nA	$V_{GS} = 10V$
	Gate-to-Source Reverse Leakage	—	—	-100		$V_{GS} = -10V$
Q_g	Total Gate Charge	—	—	16	nH	$I_D = 5.2A$ $V_{DS} = 160V$ $V_{GS} = 10V$, See Fig. 6 and 13 ④
Q_{gs}	Gate-to-Source Charge	—	—	2.7		
Q_{gd}	Gate-to-Drain ("Miller") Charge	—	—	9.6		
$t_{d(on)}$	Turn-On Delay Time	—	4.2	—		
t_r	Rise Time	—	31	—	ns	$V_{DD} = 100V$ $I_D = 5.2A$ $R_G = 9.0\Omega$ $R_D = 20\Omega$, See Fig. 10 ④
$t_{d(off)}$	Turn-Off Delay Time	—	18	—		
t_f	Fall Time	—	17	—		
L_D	Internal Drain Inductance	—	4.5	—		
L_S	Internal Source Inductance	—	7.5	—	nH	Between lead, 6mm (0.25in.) from package and center of die contact
C_{iss}	Input Capacitance	—	360	—		
C_{oss}	Output Capacitance	—	91	—	pF	$V_{GS} = 0V$ $V_{DS} = 25V$ $f = 1.0\text{MHz}$, See Fig. 5
C_{rss}	Reverse Transfer Capacitance	—	27	—		

Source-Drain Ratings and Characteristics

	Parameter	Min.	Typ.	Max.	Units	Conditions
I_S	Continuous Source Current (Body Diode)	—	—	4.0	A	MOSFET symbol showing the integral reverse p-n junction diode.
I_{SM}	Pulsed Source Current (Body Diode) ①	—	—	16		
V_{SD}	Diode Forward Voltage	—	—	1.8	V	$T_J = 25^\circ\text{C}, I_S = 4.0A, V_{GS} = 0V$ ②
t_{rr}	Reverse Recovery Time	—	180	270	ns	$T_J = 25^\circ\text{C}, I_F = 5.2A$
Q_{rr}	Reverse Recovery Charge	—	1.1	1.7	μC	$di/dt = 100A/\mu s$ ③
t_{on}	Forward Turn-On Time	Intrinsic turn-on time is negligible (turn-on is dominated by L_S+L_D)				

Notes:

① Repetitive rating; pulse width limited by max. junction temperature. (See fig. 11)

② $I_{SD} \leq 5.2A, di/dt \leq 95A/\mu s, V_{DD} \leq V_{(BR)DSS}, T_J \leq 150^\circ\text{C}$

③ $t=60s, f=60\text{Hz}$

④ $V_{DD} = 25V$, starting $T_J = 25^\circ\text{C}$, $L = 5.8\text{mH}$
 $R_G = 25\Omega, I_{AS} = 4.0A$. (See Figure 12)

⑤ Pulse width $\leq 300\mu s$; duty cycle $\leq 2\%$.

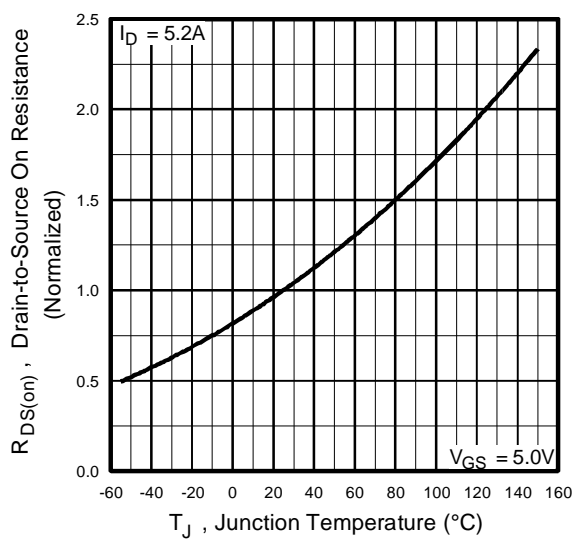
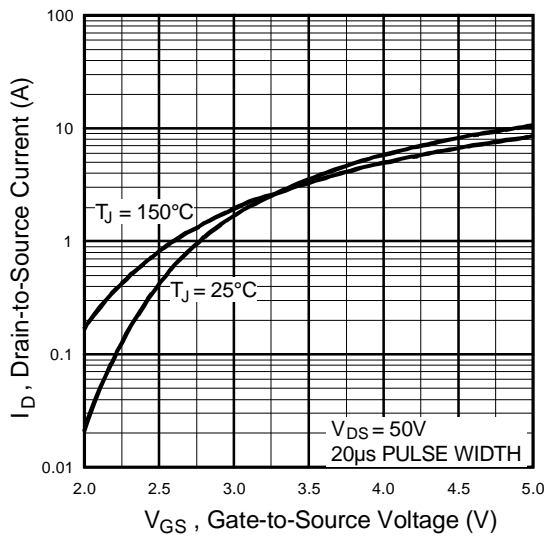
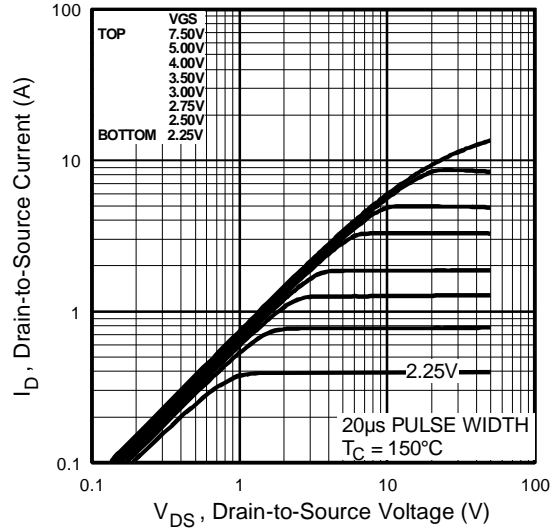
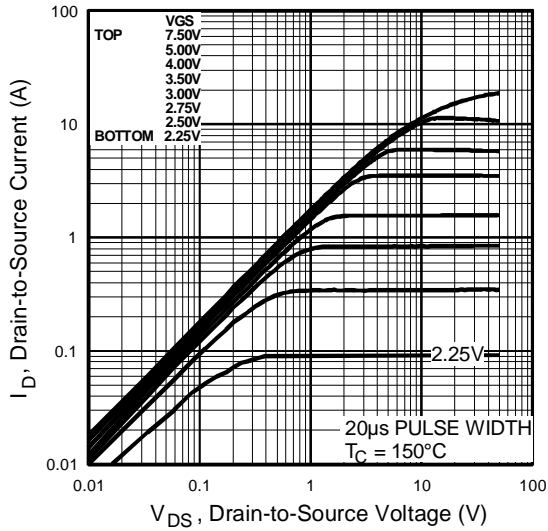

Fig 3. Typical Transfer Characteristics

Fig 4. Normalized On-Resistance Vs. Temperature

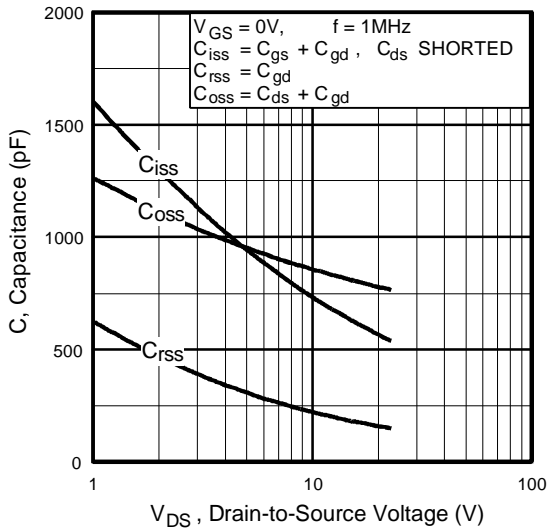

Fig 5. Typical Capacitance Vs. Drain-to-Source Voltage

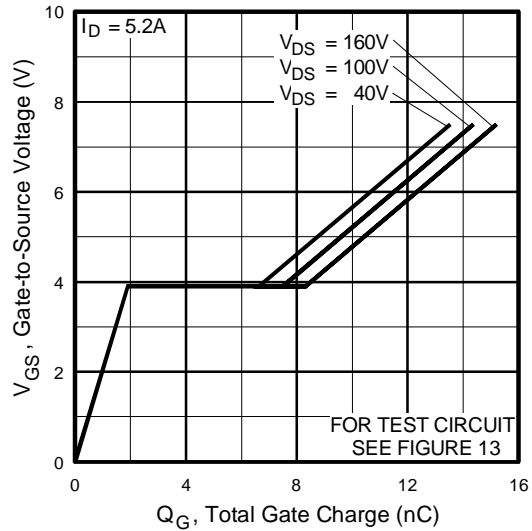

Fig 6. Typical Gate Charge Vs. Gate-to-Source Voltage

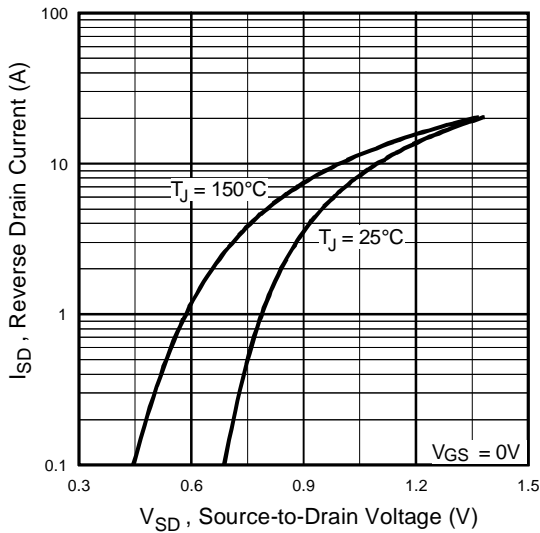

Fig 7. Typical Source-Drain Diode Forward Voltage

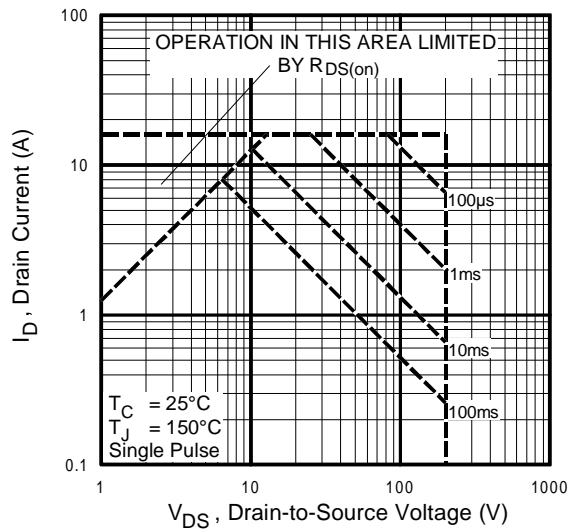

Fig 8. Maximum Safe Operating Area

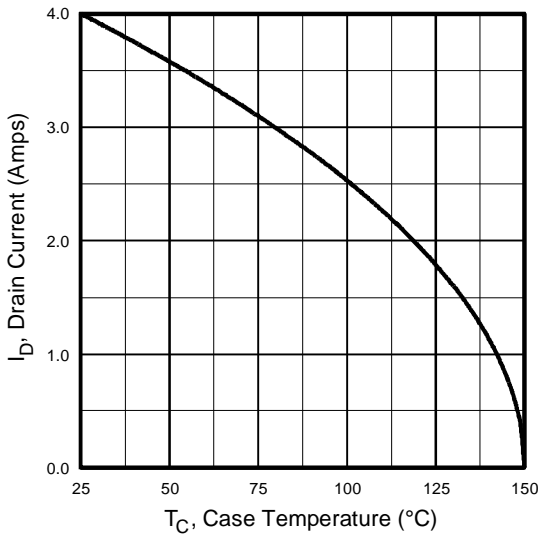

Fig 9. Maximum Drain Current Vs. Case Temperature

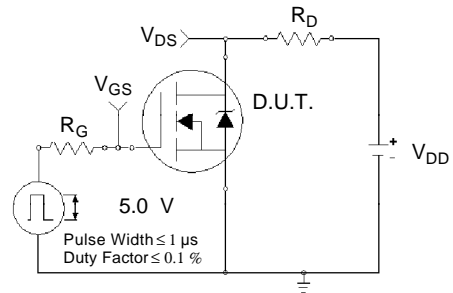

Fig 10a. Switching Time Test Circuit

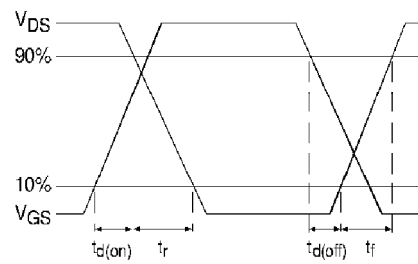

Fig 10b. Switching Time Waveforms

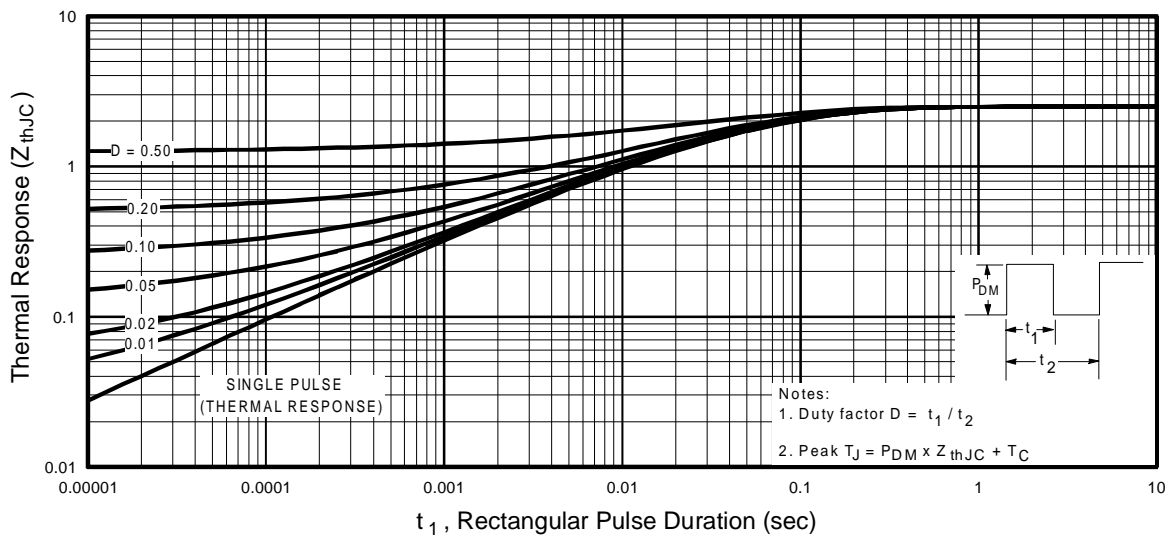

Fig 11. Maximum Effective Transient Thermal Impedance, Junction-to-Case

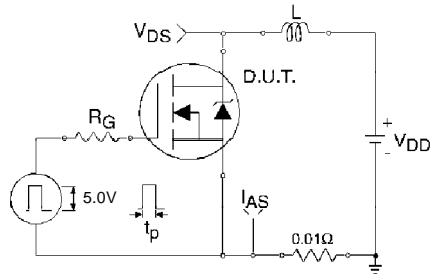

Fig 12a. Unclamped Inductive Test Circuit

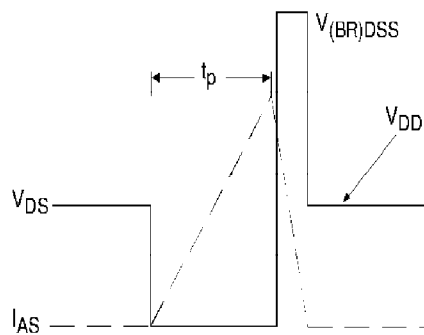

Fig 12b. Unclamped Inductive Waveforms

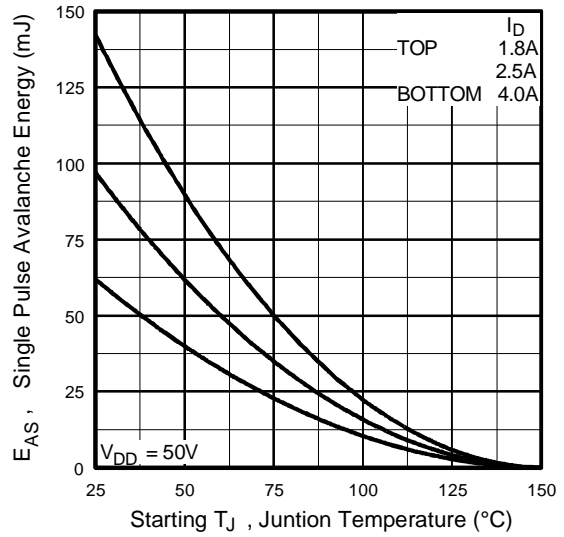

Fig 12c. Maximum Avalanche Energy Vs. Drain Current

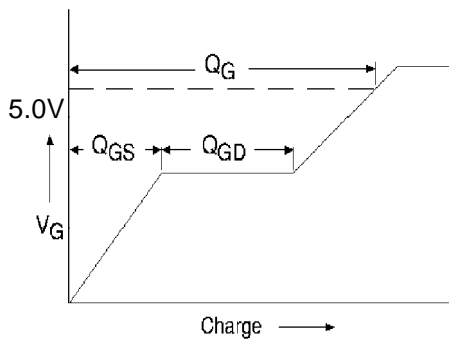

Fig 13a. Basic Gate Charge Waveform

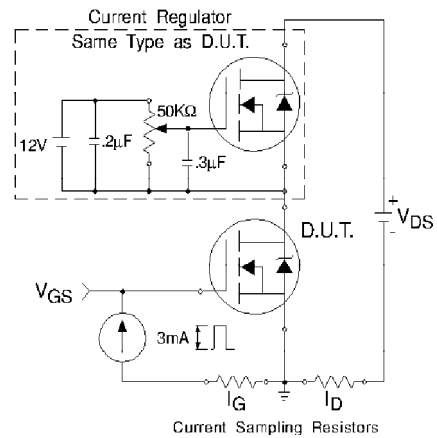
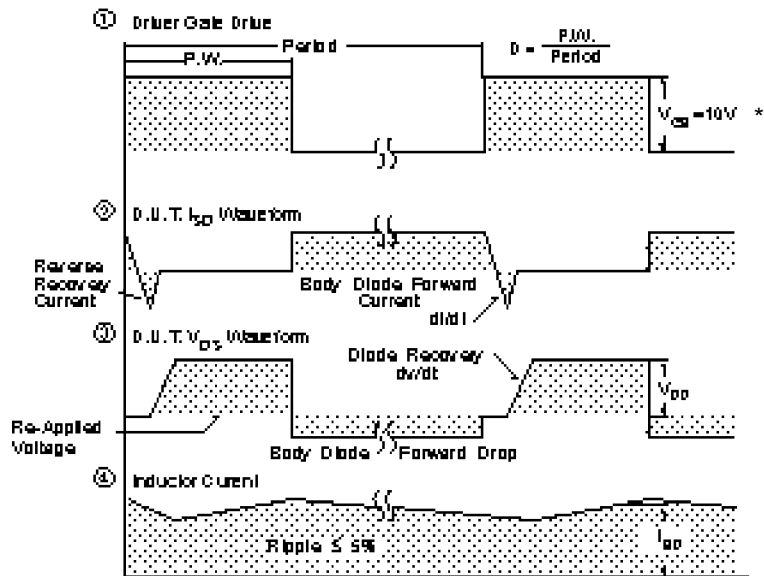
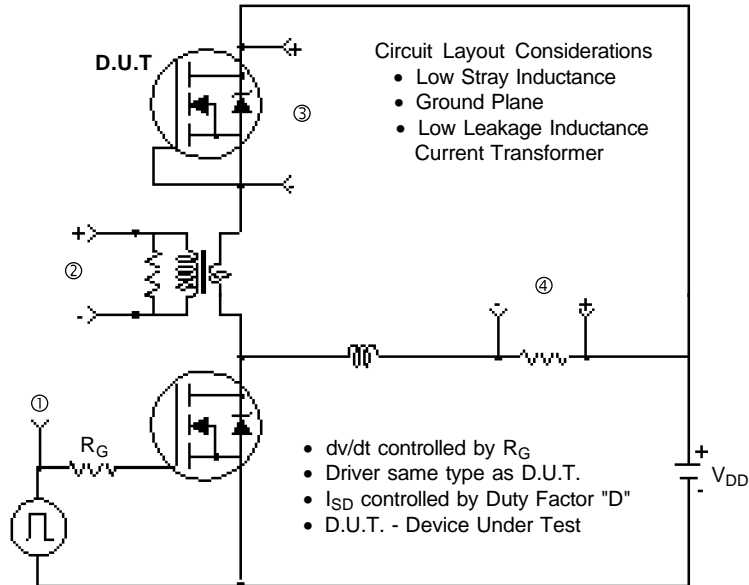

Fig 13b. Gate Charge Test Circuit

Peak Diode Recovery dv/dt Test Circuit



* $V_{GS} = 5V$ for Logic Level Devices

Fig 14. For N-Channel HEXFETS

IRLI620G



Package Outline

TO-220 Full-Pak

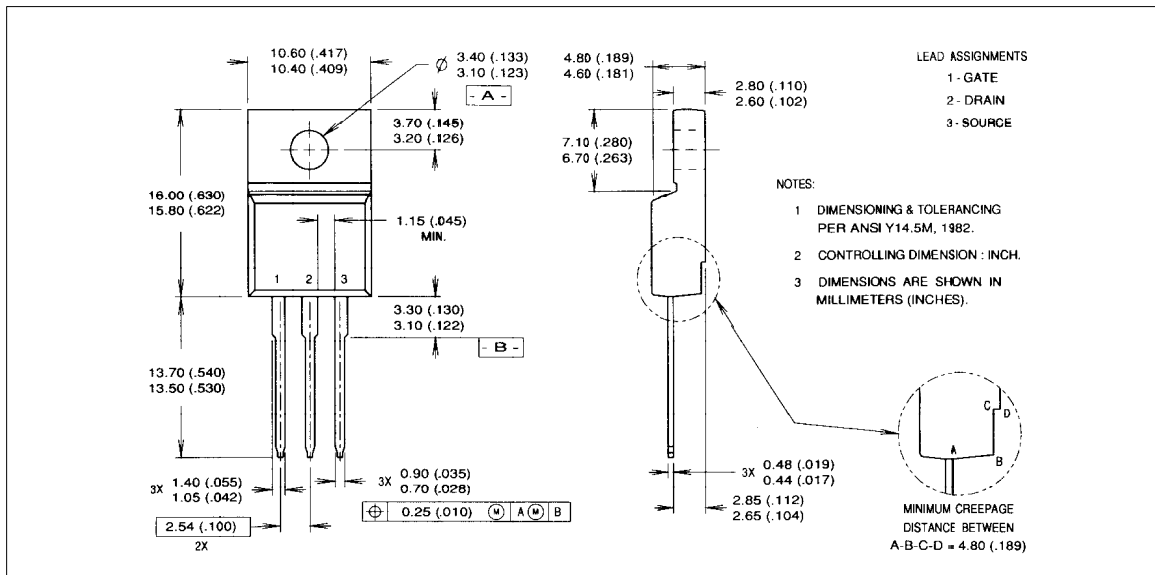

Part Marking Information

TO-220 Full-Pak

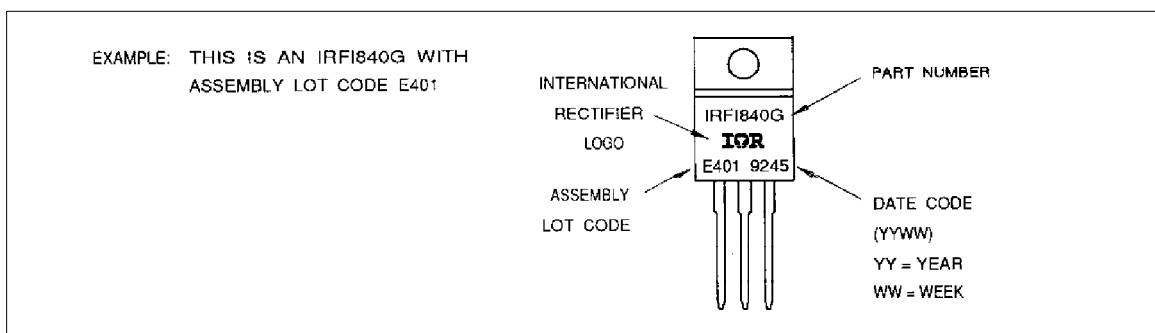

WORLD HEADQUARTERS: 233 Kansas St., El Segundo, California 90245, Tel: (310) 322 3331
EUROPEAN HEADQUARTERS: Hurst Green, Oxted, Surrey RH8 9BB, UK Tel: (44) 0883 713215
IR CANADA: 7321 Victoria Park Ave., Suite 201, Markham, Ontario L3R 3L1, Tel: (905) 475 1897 **IR GERMANY:** Saalburgstrasse 157, 61350 Bad Homburg Tel: 6172 37066 **IR ITALY:** Via Liguria 49, 10071 Borgaro, Torino Tel: (39) 1145 10111 **IR FAR EAST:** K&H Bldg., 2F, 3-30-4 Nishi-Ikeburo 3-Chome, Toshima-Ki, Tokyo 171 Tel: (03)3983 0641 **IR SOUTHEAST ASIA:** 315 Outram Road, #10-02 Tan Boon Liat Building, 0316 Tel: 65 221 8371

Data and specifications subject to change without notice.