

INTERNATIONAL RECTIFIER REPETITIVE AVALANCHE RATED AND dv/dt RATEDHEXFET[®] TRANSISTOR

IRFI360

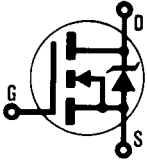

N-CHANNEL

400 Volt, 0.20 Ohm HEXFET

The HEXFET[®] technology is the key to International Rectifier's advanced line of power MOSFET transistors. The efficient geometry design achieves very low on-state resistance combined with high transconductance.

The HEXFET transistors also feature all of the well established advantages of MOSFETs such as voltage control, very fast switching, ease of paralleling and temperature stability of the electrical parameters.

They are well suited for applications such as switching power supplies and virtually any application where military and/or high reliability is required.

Product Summary

Part Number	BVDSS	RDS(on)	I _D
IRFI360	400V	0.20Ω	25A

FEATURES:

- Repetitive Avalanche Rating
- Dynamic dv/dt Rating
- Isolated and Hermetically Sealed
- Alternative to TO-3 Package
- Simple Drive Requirements
- Ease of Paralleling
- Ceramic Eyelets

CASE STYLE AND DIMENSIONS

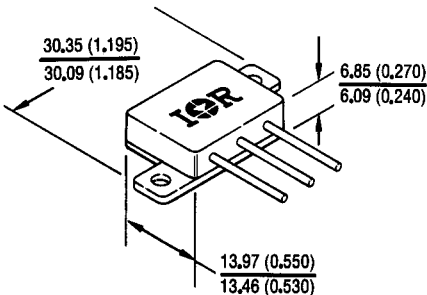

CAUTION

BERYLLIA WARNING PER MIL-S-19500
SEE PAGE I-280

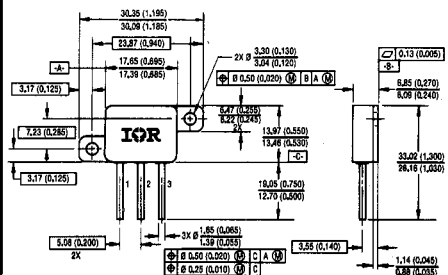

NOTES:

- 1 DIMENSIONING & TOLERANCING PER ANSI Y14.5M - 1982.
- 2 DIMENSIONS ARE SHOWN IN MILLIMETERS (INCHES).

*For optional leadforms see page I-260, fig. 15

LEGEND

- 1 DRAIN
- 2 SOURCE
- 3 GATE

Conforms to JEDEC Outline TO-259AA*
Dimensions in Millimeters and (Inches)

Absolute Maximum Ratings

Parameter	IRFI360	Units
I_D @ $V_{GS} = 10V$, $T_C = 25^\circ C$	25	A
I_D @ $V_{GS} = 10V$, $T_C = 100^\circ C$	16	
I_{DM}	100	
P_D @ $T_C = 25^\circ C$	300	W
	2.4	W/K ⑤
V_{GS}	± 20	V
E_{AS}	980	mJ
I_{AR}	25	A
E_{AR}	30	mJ
dv/dt	4.0	V/ns
T_J T_{STG}	-55 to 150	°C
	300 (0.063 in. (1.6 mm) from case for 10s)	
	10.9 (typical)	
		g

Electrical Characteristics @ $T_J = 25^\circ C$ (Unless Otherwise Specified)

Parameter	Min.	Typ.	Max.	Units	Test Conditions
BV_{DSS}	400	—	—	V	$V_{GS} = 0V$, $I_D = 1.0$ mA
$\Delta BV_{DSS}/\Delta T_J$	—	0.46	—	V/°C	Reference to $25^\circ C$, $I_D = 1.0$ mA
$R_{DS(on)}$	—	—	0.20	Ω	$V_{GS} = 10V$, $I_D = 16A$ ④
	—	—	0.23		$V_{GS} = 10V$, $I_D = 25A$
$V_{GS(th)}$	2.0	—	4.0	V	$V_{DS} = V_{GS}$, $I_D = 250$ μA
g_{fs}	14	—	—	S (ft)	$V_{DS} \geq 15V$, $I_{DS} = 16A$ ④
I_{DSS}	—	—	25	μA	$V_{DS} = 0.8 \times$ Max. Rating, $V_{GS} = 0V$
	—	—	250		$V_{DS} = 0.8 \times$ Max. Rating $V_{GS} = 0V$, $T_J = 125^\circ C$
I_{GSS}	—	—	100	nA	$V_{GS} = 20V$
I_{GSS}	—	—	-100		$V_{GS} = -20V$
Q_g	—	—	210	nC	$V_{GS} = 10V$, $I_D = 25A$
Q_{gs}	—	—	28		$V_{DS} = 0.5 \times$ Max. Rating
Q_{gd}	—	—	120		See Fig. 6 and 14
$t_{d(on)}$	—	—	33	ns	$V_{DD} = 200V$, $I_D = 25A$, $R_G = 2.35\Omega$ See Fig. 11
t_r	—	—	140		
$t_{d(off)}$	—	—	120		
t_f	—	—	99		
L_D	—	8.7	—	nH	Measured from the drain lead, 6 mm (0.25 in.) from package to center of die.
L_S	—	8.7	—		Measured from the source lead, 6 mm (0.25 in.) from package to source bonding pad.
C_{iss}	—	4200	—	pF	$V_{GS} = 0V$, $V_{DS} = 25V$ $f = 1.0$ MHz See Fig. 5 $f = 1.0$ MHz
C_{oss}	—	900	—		
C_{rss}	—	400	—		
C_{DC}	—	12	—		

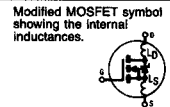

Source-Drain Diode Ratings and Characteristics

Parameter		Min.	Typ.	Max.	Units	Test Conditions
I_S	Continuous Source Current (Body Diode)	—	—	25	A	Modified MOSFET symbol showing the integral Reverse p-n junction rectifier. 
I_{SM}	Pulsed Source Current (Body Diode) ①	—	—	100		
V_{SD}	Diode Forward Voltage	—	—	1.8	V	$T_J = 25^\circ\text{C}$, $I_S = 25\text{A}$, $V_{GS} = 0\text{V}$ ④
t_{rr}	Reverse Recovery Time	—	—	1000	nS	$T_J = 25^\circ\text{C}$, $I_F = 25\text{A}$, $di/dt = \leq 100\text{ A}/\mu\text{s}$ ④
Q_{RR}	Reverse Recovery Charge	—	—	16	μC	$V_{DD} \leq 50\text{V}$
t_{on}	Forward Turn-On Time	Intrinsic turn-on time is negligible. Turn-on speed is substantially controlled by $L_S + L_D$.				

Thermal Resistance

Parameter		Min.	Typ.	Max.	Units	Test Conditions
R_{thJC}	Junction-to-Case	—	—	0.42	K/W ⑤	
R_{thCS}	Case-to-Sink	—	0.21	—		Mounting surface flat, smooth, and greased
R_{thJA}	Junction-to-Ambient	—	—	30		Typical socket mount

① Repetitive Rating; Pulse width limited by maximum junction temperature (see figure 9) Refer to current HEXFET reliability report

② @ $V_{DD} = 50\text{V}$, Starting $T_J = 25^\circ\text{C}$,
 $L \geq 2.7\text{ mH}$, $R_G = 25\Omega$,
Peak $I_L = 25\text{A}$

③ $I_{SD} \leq 25\text{A}$, $di/dt \leq 170\text{ A}/\mu\text{s}$,
 $V_{DD} \leq BV_{DSS}$, $T_J \leq 150^\circ\text{C}$
Suggested $R_G = 2.35\Omega$

④ Pulse width $\leq 300\ \mu\text{s}$; Duty Cycle $\leq 2\%$

⑤ K/W = $^\circ\text{C}/\text{W}$
W/K = $\text{W}/^\circ\text{C}$

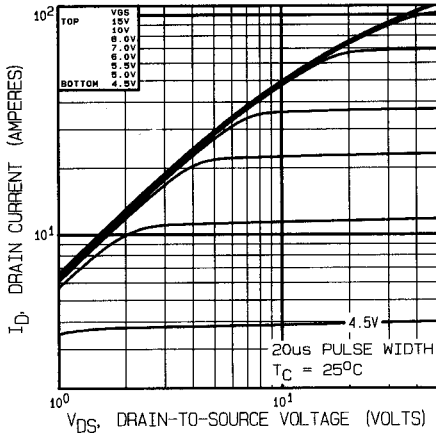

Fig. 1 — Typical Output Characteristics, $T_C = 25^\circ\text{C}$

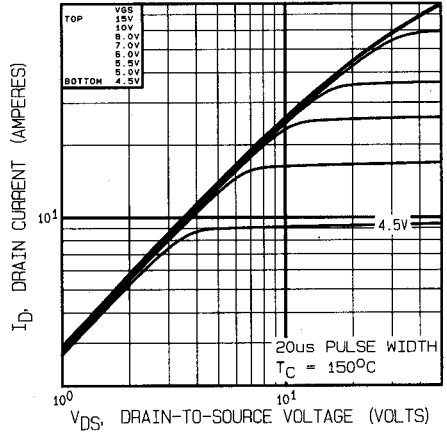

Fig. 2 — Typical Output Characteristics, $T_C = 150^\circ\text{C}$

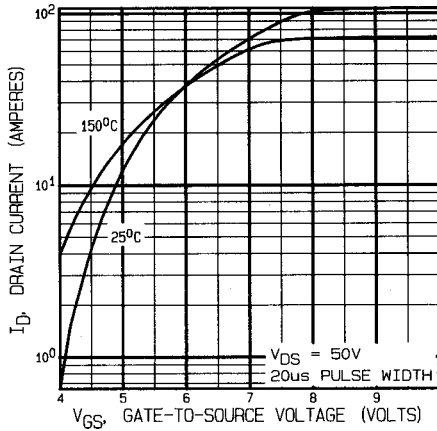

Fig. 3 — Typical Transfer Characteristics

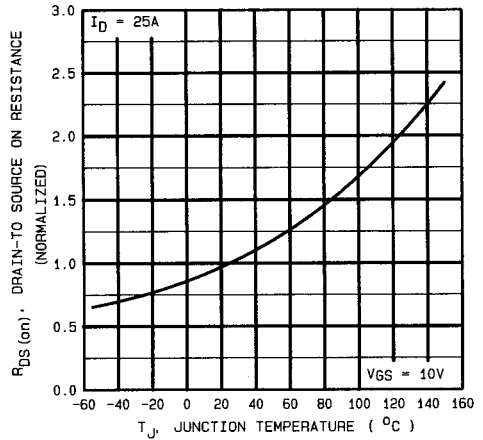
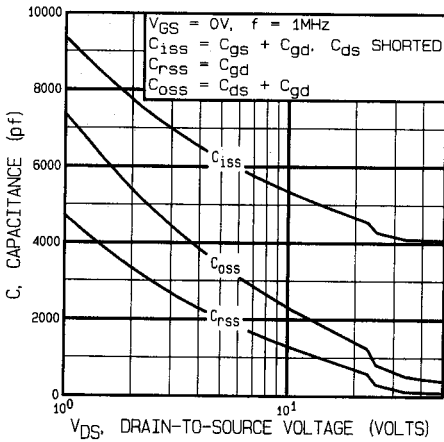
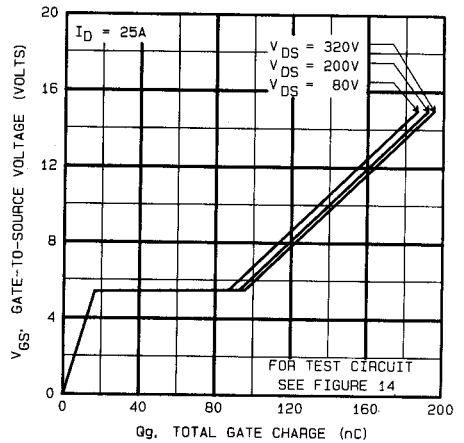
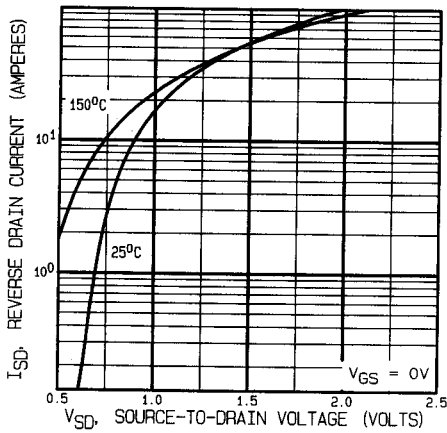
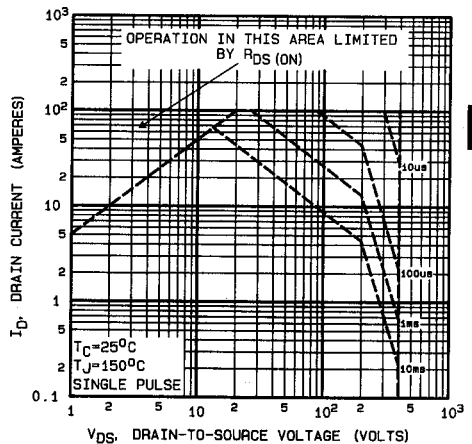

Fig. 4 — Normalized On-Resistance Vs. Temperature

Fig. 5 — Typical Capacitance Vs. Drain-to-Source Voltage

Fig. 6 — Typical Gate Charge Vs. Gate-to-Source Voltage

Fig. 7 — Typical Source-Drain Diode Forward Voltage

Fig. 8 — Maximum Safe Operating Area

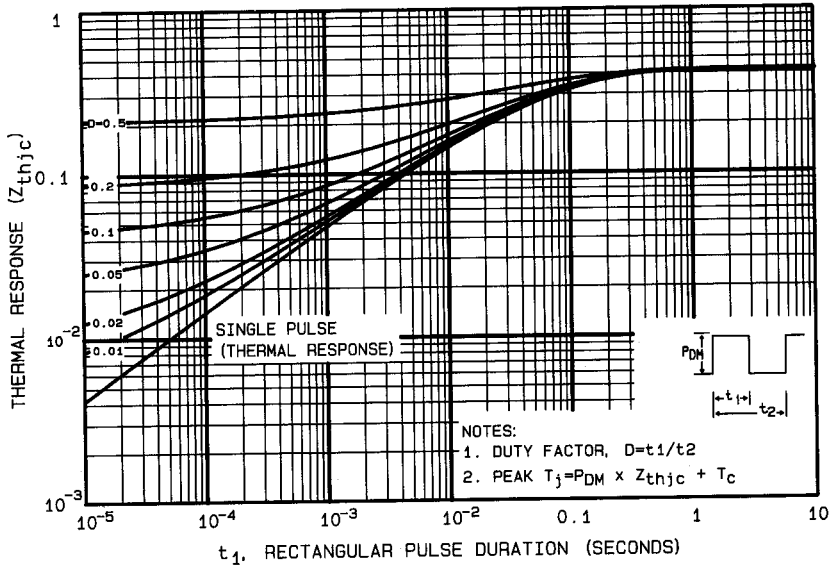

Fig. 9 — Maximum Effective Transient Thermal Impedance, Junction-to-Case Vs. Pulse Duration

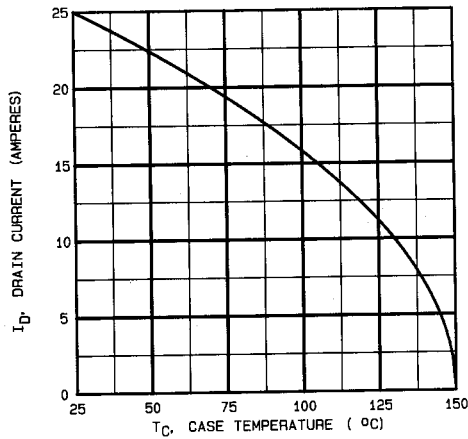

Fig. 10 — Maximum Drain Current Vs. Case Temperature

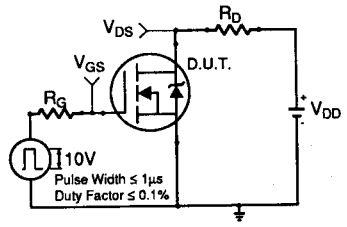

Fig. 11a — Switching Time Test Circuit

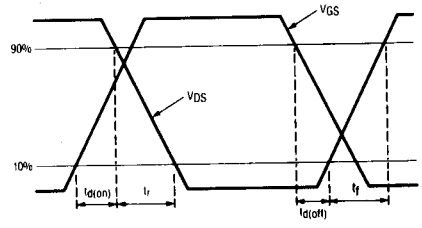
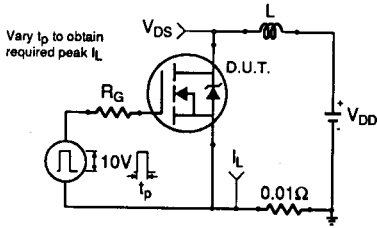
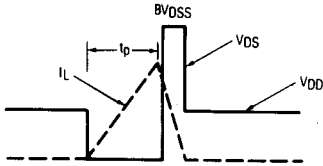
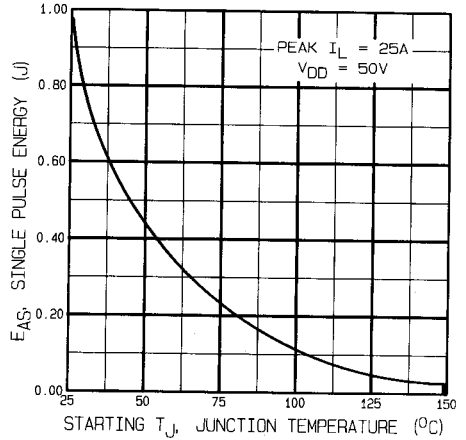
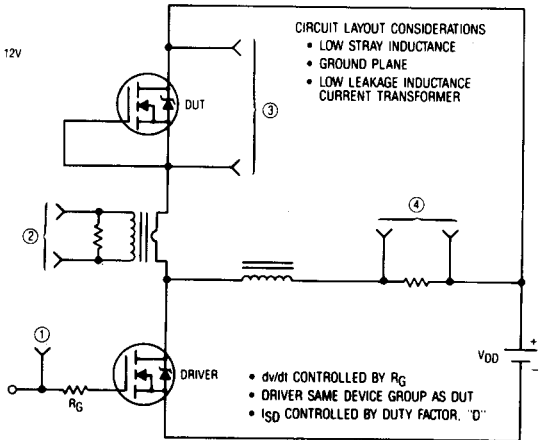
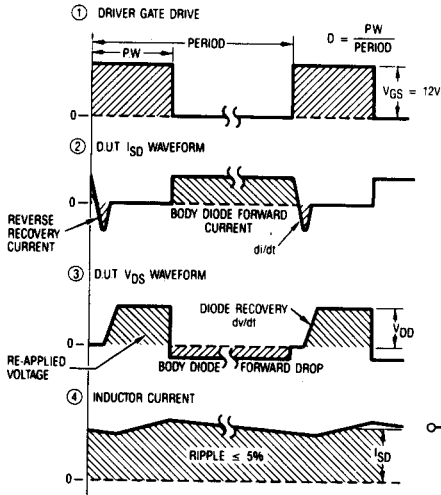

Fig. 11b — Switching Time Waveforms

Fig. 12a — Unclamped Inductive Test Circuit

Fig. 12b — Unclamped Inductive Waveforms

Fig. 12c — Maximum Avalanche Energy Vs. Starting Junction Temperature

Fig. 13 — Peak Diode Recovery dv/dt Test Circuit

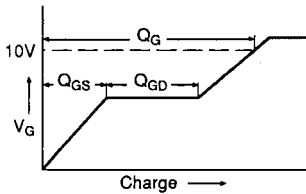

Fig. 14a — Basic Gate Charge Waveform

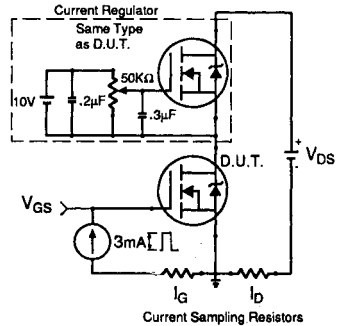

Fig. 14b — Gate Charge Test Circuit

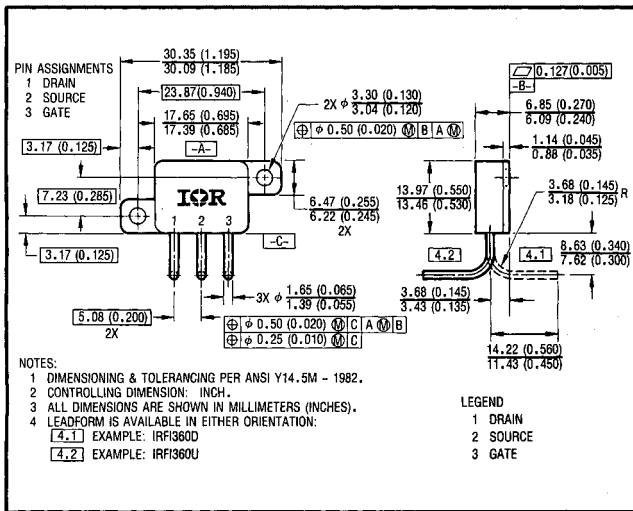

Fig. 15 — Optional Leadforms for Outline TO-269

BERYLLIA WARNING PER MIL-S-19500

Packages containing beryllia shall not be ground, sandblasted, machined, or have other operations performed on them which will produce beryllia or beryllium dust. Furthermore, beryllium oxide packages shall not be placed in acids that will produce fumes containing beryllium.