

# IRFL110

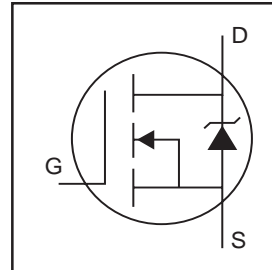
## HEXFET® Power MOSFET

- Surface Mount
- Available in Tape & Reel
- Dynamic dv/dt Rating
- Repetitive Avalanche Rated
- Fast Switching
- Ease of Paralleling
- Simple Drive Requirements

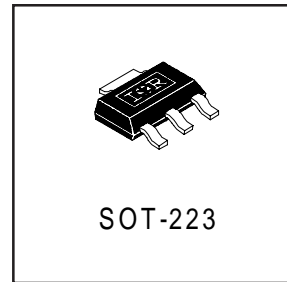
### Description

Third Generation HEXFETs from International Rectifier provide the designer with the best combination of fast switching, ruggedized device design, low on-resistance and cost-effectiveness.

The SOT-223 package is designed for surface-mount using vapor phase, infra red, or wave soldering techniques. Its unique package design allows for easy automatic pick-and-place as with other SOT or SOIC packages but has the added advantage of improved thermal performance due to an enlarged tab for heatsinking. Power dissipation of greater than 1.25W is possible in a typical surface mount application.



|                           |
|---------------------------|
| $V_{DSS} = 100V$          |
| $R_{DS(on)} = 0.54\Omega$ |
| $I_D = 1.5A$              |



### Absolute Maximum Ratings

|                           | Parameter                                 | Max.                  | Units |
|---------------------------|---|-----------------------|-------|
| $I_D @ T_C = 25^\circ C$  | Continuous Drain Current, $V_{GS} @ 10 V$ | 1.5                   | A     |
| $I_D @ T_C = 100^\circ C$ | Continuous Drain Current, $V_{GS} @ 10 V$ | 0.96                  |       |
| $I_{DM}$                  | Pulsed Drain Current ①                    | 12                    |       |
| $P_D @ T_C = 25^\circ C$  | Power Dissipation                         | 3.1                   | W     |
| $P_D @ T_A = 25^\circ C$  | Power Dissipation (PCB Mount)**           | 2.0                   |       |
|                           | Linear Derating Factor                    | 0.025                 | W/°C  |
|                           | Linear Derating Factor (PCB Mount)**      | 0.017                 |       |
| $V_{GS}$                  | Gate-to-Source Voltage                    | -/+20                 | V     |
| $E_{AS}$                  | Single Pulse Avalanche Energy ②           | 150                   | mJ    |
| $I_{AR}$                  | Avalanche Current ①                       | 1.5                   | A     |
| $E_{AR}$                  | Repetitive Avalanche Energy ①             | 0.31                  | mJ    |
| dv/dt                     | Peak Diode Recovery dv/dt ③               | 5.5                   | V/ns  |
| $T_J, T_{STG}$            | Junction and Storage Temperature Range    | -55 to + 150          | °C    |
|                           | Soldewring Temperature, for 10 seconds    | 300 (1.6mm from case) |       |


### Thermal Resistance

|                 | Parameter                          | Typ. | Max. | Units |
|-----------------|------------------------------------|------|------|-------|
| $R_{\theta JC}$ | Junction-to-PCB                    | —    | 40   | °C/W  |
| $R_{\theta JA}$ | Junction-to-Ambient. (PCB Mount)** | —    | 60   |       |

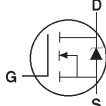
\*\* When mounted on 1" square pcb (FR-4 or G-10 Material).

For recommended footprint and soldering techniques refer to application note #AN-994.

## Electrical Characteristics @ $T_J = 25^\circ\text{C}$ (unless otherwise specified)

|                                 | Parameter                            | Min. | Typ. | Max. | Units    | Conditions  |
|---------------------------------|--------------------------------------|------|------|------|----------|---|
| $V_{(BR)DSS}$                   | Drain-to-Source Breakdown Voltage    | 100  | —    | —    | V        | $V_{GS} = 0V, I_D = 250\mu A$   |
| $\Delta V_{(BR)DSS}/\Delta T_J$ | Breakdown Voltage Temp. Coefficient  | —    | 0.63 | —    | V/°C     | Reference to $25^\circ\text{C}, I_D = 1\text{mA}$                                     |
| $R_{DS(on)}$                    | Static Drain-to-Source On-Resistance | —    | —    | 0.54 | $\Omega$ | $V_{GS} = 10V, I_D = 0.90A$ ④   |
| $V_{GS(th)}$                    | Gate Threshold Voltage               | 2.0  | —    | 4.0  | V        | $V_{DS} = V_{GS}, I_D = 250\mu A$   |
| $g_{fs}$                        | Forward Transconductance             | 1.1  | —    | —    | S        | $V_{DS} = 50V, I_D = 0.90A$ ④   |
| $I_{DSS}$                       | Drain-to-Source Leakage Current      | —    | —    | 25   | $\mu A$  | $V_{DS} = 100V, V_{GS} = 0V$  |
|                                 |                                      | —    | —    | 250  |          | $V_{DS} = 80V, V_{GS} = 0V, T_J = 125^\circ\text{C}$                                  |
| $I_{GSS}$                       | Gate-to-Source Forward Leakage       | —    | —    | 100  | nA       | $V_{GS} = 20V$  |
|                                 | Gate-to-Source Reverse Leakage       | —    | —    | -100 |          | $V_{GS} = -20V$   |
| $Q_g$                           | Total Gate Charge                    | —    | —    | 8.3  | nC       | $I_D = 5.6A$  |
| $Q_{gs}$                        | Gate-to-Source Charge                | —    | —    | 2.3  |          | $V_{DS} = 80V$  |
| $Q_{gd}$                        | Gate-to-Drain ("Miller") Charge      | —    | —    | 3.8  |          | $V_{GS} = 10V$ , See Fig. 6 and 13 ④  |
| $t_{d(on)}$                     | Turn-On Delay Time                   | —    | 6.9  | —    | ns       | $V_{DD} = 50V$  |
| $t_r$                           | Rise Time                            | —    | 16   | —    |          | $I_D = 5.6A$  |
| $t_{d(off)}$                    | Turn-Off Delay Time                  | —    | 15   | —    |          | $R_G = 24\Omega$  |
| $t_f$                           | Fall Time                            | —    | 9.4  | —    |          | $R_D = 8.4\Omega$ , See Fig. 10 ④   |
| $L_D$                           | Internal Drain Inductance            | —    | 4.0  | —    | nH       | Between lead, 6mm(0.25in) from package and center of die contact.                     |
| $L_S$                           | Internal Source Inductance           | —    | 6.0  | —    |          |  |
| $C_{iss}$                       | Input Capacitance                    | —    | 180  | —    | pF       | $V_{GS} = 0V$   |
| $C_{oss}$                       | Output Capacitance                   | —    | 81   | —    |          | $V_{DS} = 25V$  |
| $C_{rss}$                       | Reverse Transfer Capacitance         | —    | 15   | —    |          | $f = 1.0\text{MHz}$ , See Fig. 5  |

## Source-Drain Ratings and Characteristics

|          | Parameter                              | Min.  | Typ. | Max. | Units   | Conditions   |
|----------|--|---|------|------|---------|--|
| $I_S$    | Continuous Source Current (Body Diode) | —   | —    | 1.5  | A       | MOSFET symbol showing the integral reverse p-n junction diode.  |
| $I_{SM}$ | Pulsed Source Current (Body Diode) ①   | —   | —    | 12   |         |  |
| $V_{SD}$ | Diode Forward Voltage                  | —   | —    | 2.5  | V       | $T_J = 25^\circ\text{C}, I_S = 1.5A, V_{GS} = 0V$ ④  |
| $t_{rr}$ | Reverse Recovery Time                  | —   | 100  | 200  | ns      | $T_J = 25^\circ\text{C}, I_F = 5.6A$   |
| $Q_{rr}$ | Reverse Recovery Charge                | —   | 0.44 | 0.88 | $\mu C$ | $di/dt = 100A/\mu s$ ④   |
| $t_{on}$ | Forward Turn-On Time                   | Intrinsic turn-on time is negligible (turn-on is dominated by $L_S+L_D$ ) |      |      |         |  |

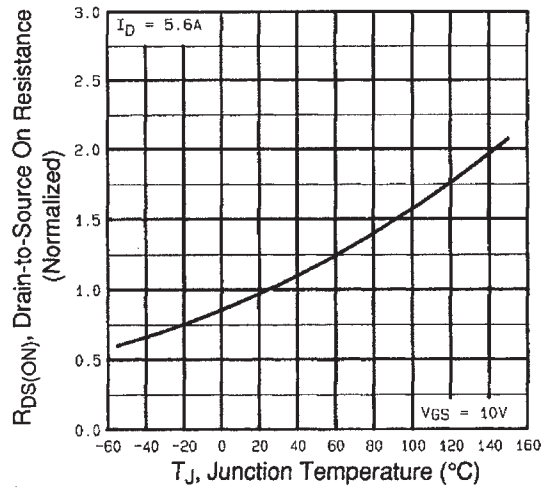
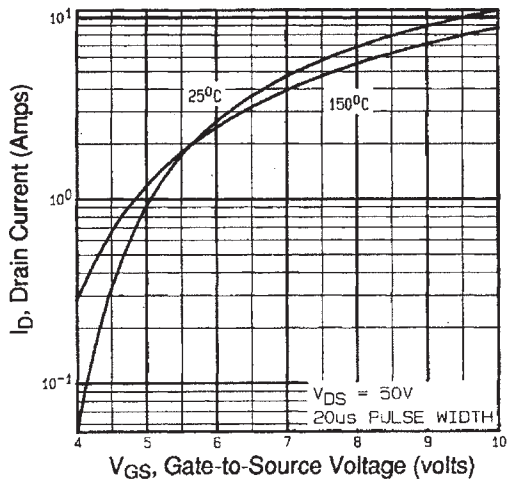
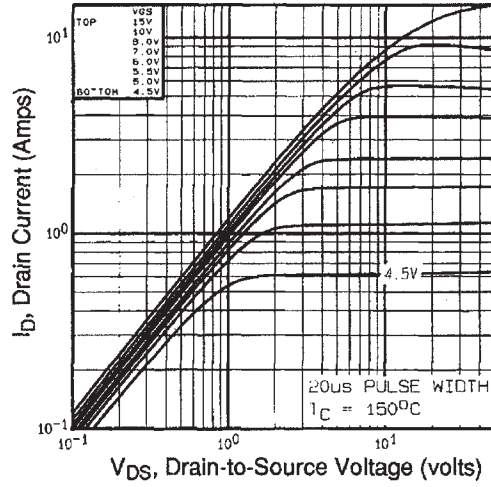
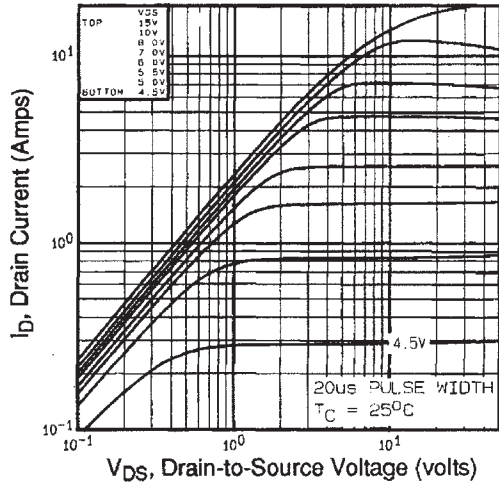
### Notes:

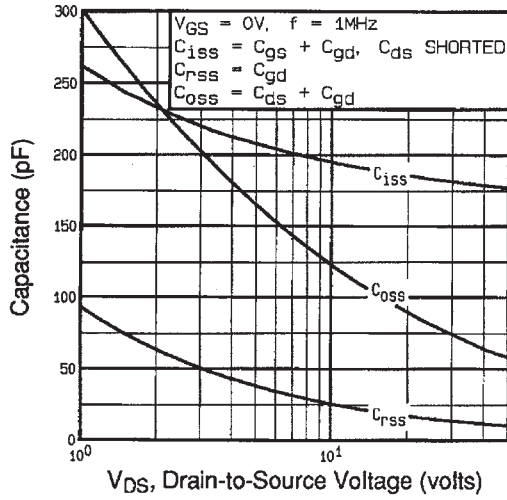
① Repetitive rating; pulse width limited by max. junction temperature. ( See fig. 11 )

②  $V_{DD}=25V$ , starting  $T_J = 25^\circ\text{C}$ ,  $L = 25\text{mH}$   
 $R_G = 25\Omega, I_{AS} = 3.0A$  (See Figure 12)

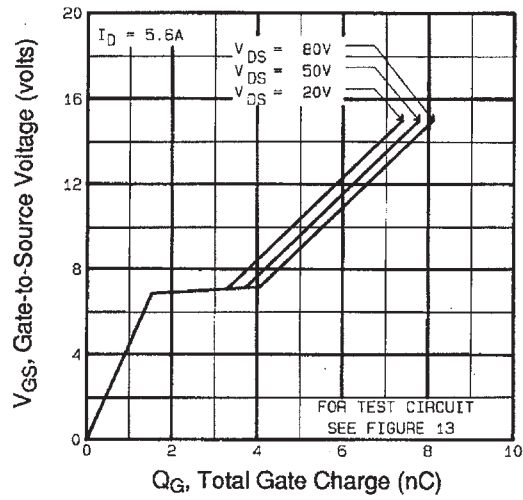
③  $I_{SD} \leq 5.6A, di/dt \leq 75A/\mu s, V_{DD} \leq V_{(BR)DSS}, T_J \leq 150^\circ\text{C}$

④ Pulse width  $\leq 300\mu s$ ; duty cycle  $\leq 2\%$ .

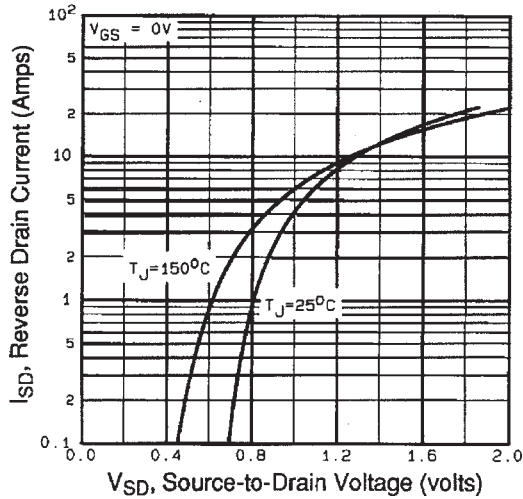




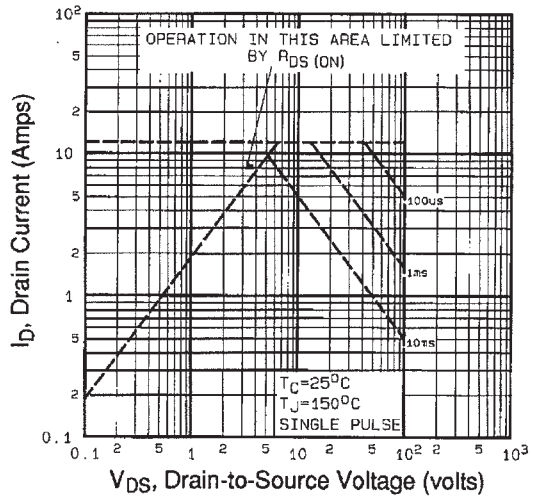
**Fig 5.** Typical Capacitance Vs. Drain-to-Source Voltage



**Fig 6.** Typical Gate Charge Vs. Gate-to-Source Voltage



**Fig 7.** Typical Source-Drain Diode Forward Voltage



**Fig 8.** Maximum Safe Operating Area

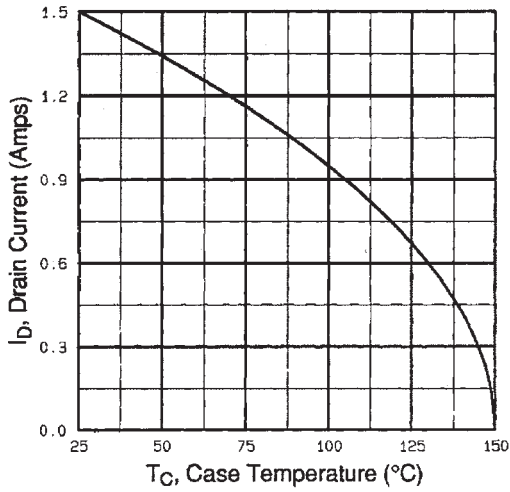


Fig 9. Maximum Drain Current Vs. Case Temperature

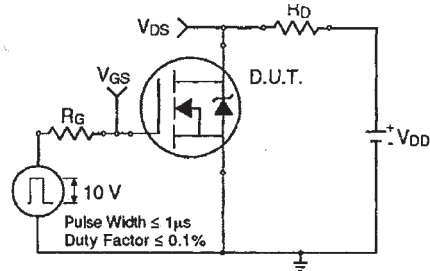


Fig 10a. Switching Time Test Circuit

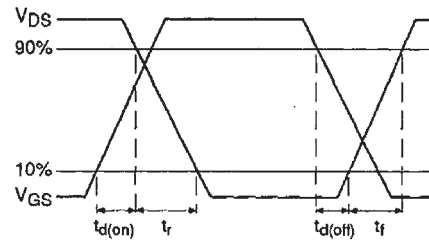


Fig 10b. Switching Time Waveforms

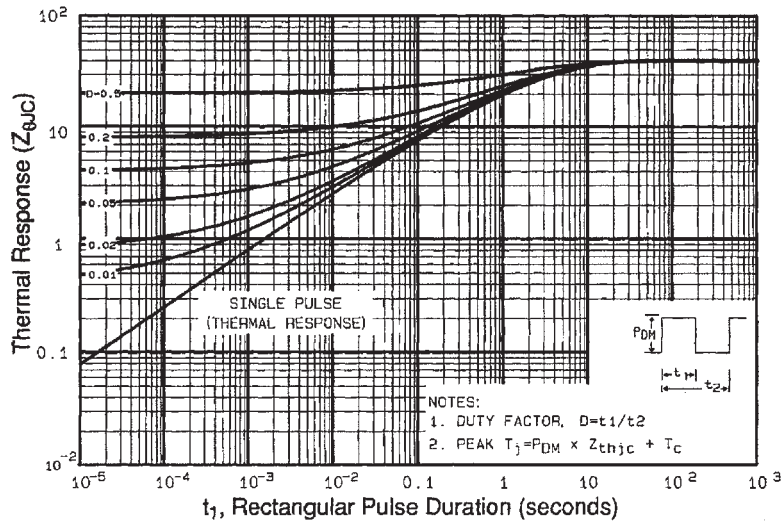
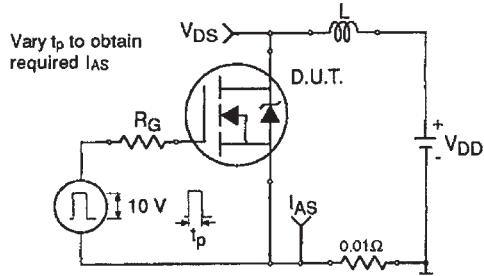
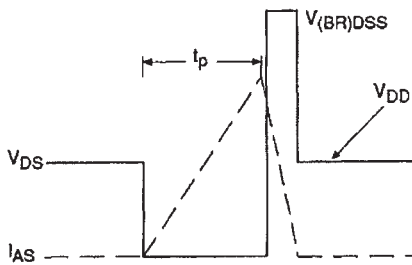


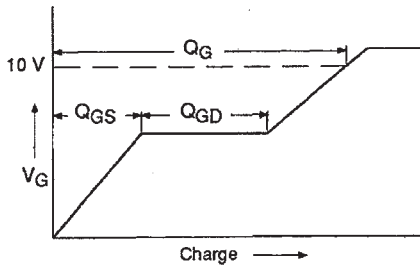
Fig 11. Maximum Effective Transient Thermal Impedance, Junction-to-Case



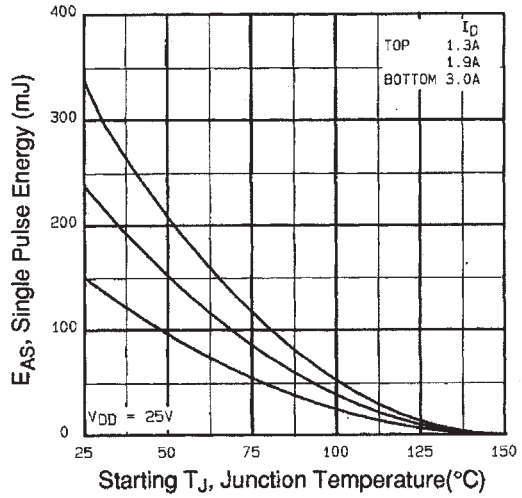
**Fig 12a.** Unclamped Inductive Test Circuit



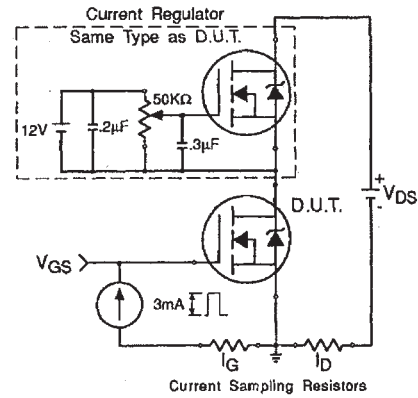
**Fig 12b.** Unclamped Inductive Waveforms



**Fig 13a.** Basic Gate Charge Waveform



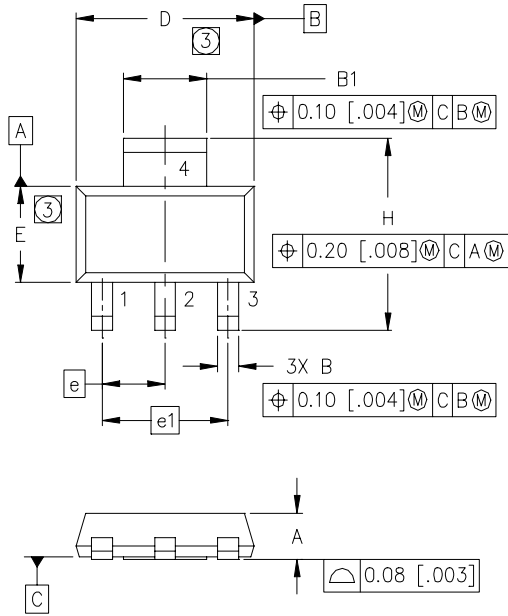
**Fig 12c.** Maximum Avalanche Energy Vs. Drain Current



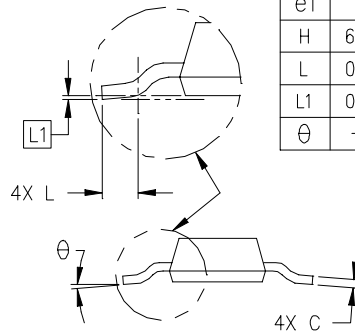
**Fig 13b.** Gate Charge Test Circuit

International  
**IR** Rectifier  
**Package Outline**  
**SOT-223 (TO-261AA) Outline**

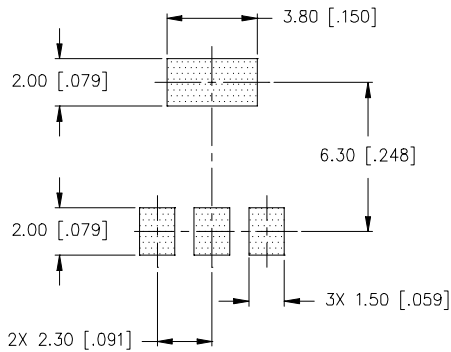
# IRFL110



| DIM      | MILLIMETERS |      | INCHES |      |
|----------|-------------|------|--------|------|
|          | MIN         | MAX  | MIN    | MAX  |
| A        | 1.55        | 1.80 | .061   | .071 |
| B        | 0.65        | 0.85 | .026   | .033 |
| B1       | 2.95        | 3.15 | .116   | .124 |
| C        | 0.25        | 0.35 | .010   | .014 |
| D        | 6.30        | 6.70 | .248   | .264 |
| E        | 3.30        | 3.70 | .130   | .146 |
| e        | 2.30        | BSC  | .0905  | BSC  |
| e1       | 4.60        | BSC  | .181   | BSC  |
| H        | 6.71        | 7.29 | .264   | .287 |
| L        | 0.91        | —    | .036   | —    |
| L1       | 0.061       | BSC  | .0024  | BSC  |
| $\theta$ | —           | 10°  | —      | 10°  |



MINIMUM RECOMMENDED FOOTPRINT



LEAD ASSIGNMENTS

- 1 = GATE
- 2 = DRAIN
- 3 = SOURCE
- 4 = DRAIN

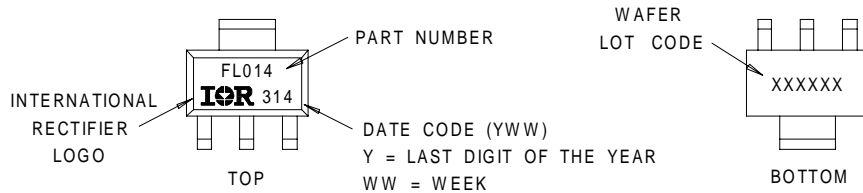
NOTES:

1. DIMENSIONING & TOLERANCING PER ASME Y14.5M-1994.
2. CONTROLLING DIMENSION: INCH.
- ③ DIMENSIONS DO NOT INCLUDE MOLD FLASH.
4. OUTLINE CONFORMS TO JEDEC OUTLINE TO-261AA.
5. DIMENSIONS ARE SHOWN IN MILLIMETERS [INCHES].

## Part Marking Information

SOT-223

EXAMPLE : THIS IS AN IRFL014

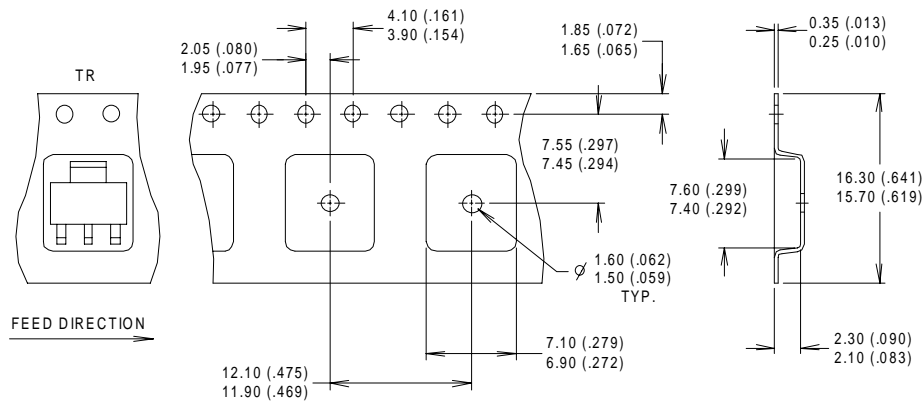


# IRFL110

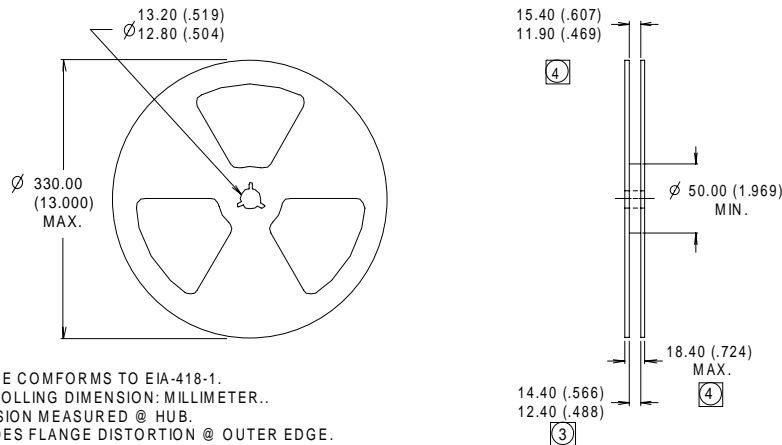
International  
**IR** Rectifier

## Tape & Reel Information

### SOT-223 Outline



- NOTES :
1. CONTROLLING DIMENSION: MILLIMETER.
  2. OUTLINE CONFORMS TO EIA-481 & EIA-541.
  3. EACH  $\phi$ 330.00 (13.00) REEL CONTAINS 2,500 DEVICES.



- NOTES :
1. OUTLINE COMFORMS TO EIA-418-1.
  2. CONTROLLING DIMENSION: MILLIMETER..
  - ③ DIMENSION MEASURED @ HUB.
  - ④ INCLUDES FLANGE DISTORTION @ OUTER EDGE.

International  
**IR** Rectifier

**WORLD HEADQUARTERS:** 233 Kansas St., El Segundo, California 90245, Tel: (310) 322 3331

**IR GREAT BRITAIN:** Hurst Green, Oxted, Surrey RH8 9BB, UK Tel: ++ 44 1883 732020

**IR CANADA:** 15 Lincoln Court, Brampton, Ontario L6T3Z2, Tel: (905) 453 2200

**IR GERMANY:** Saalburgstrasse 157, 61350 Bad Homburg Tel: ++ 49 6172 96590

**IR ITALY:** Via Liguria 49, 10071 Borgaro, Torino Tel: ++ 39 11 451 0111

**IR FAR EAST:** K&H Bldg., 2F, 30-4 Nishi-Ikebukuro 3-Chome, Toshima-Ku, Tokyo Japan 171 Tel: 81 3 3983 0086

**IR SOUTHEAST ASIA:** 1 Kim Seng Promenade, Great World City West Tower, 13-11, Singapore 237994 Tel: ++ 65 838 4630

**IR TAIWAN:** 16 Fl. Suite D. 207, Sec. 2, Tun Haw South Road, Taipei, 10673, Taiwan Tel: 886-2-2377-9936

<http://www.irf.com/> Data and specifications subject to change without notice. 1/99