

IRF6601

DirectFET™ Power MOSFET

- Application Specific MOSFETs
- Ideal for CPU Core DC-DC Converters
- Low Conduction Losses
- Low Switching Losses
- Low Profile (<0.7 mm)
- Dual Sided Cooling Compatible
- Compatible with existing Surface Mount Techniques

V _{DSS}	R _{DS(on)} max	I _D
20V	3.8mΩ@V _{GS} = 10V	26A
	5.0mΩ@V _{GS} = 4.5V	21A

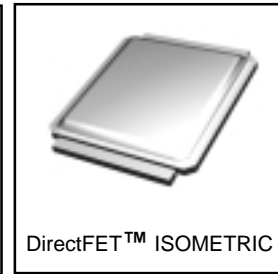
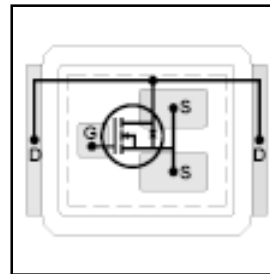

Description

The IRF6601 combines the latest HEXFET® Power MOSFET Silicon technology with the advanced DirectFET™ packaging to achieve the lowest on-state resistance in a package that has the footprint of an SO-8 and only 0.7 mm profile. The DirectFET package is compatible with existing layout geometries used in power applications, PCB assembly equipment and vapor phase, infra-red or convection soldering techniques. The DirectFET package allows dual sided cooling to maximize thermal transfer in power systems, IMPROVING previous best thermal resistance by 80%.

The IRF6601 balances both low resistance and low charge along with ultra low package inductance to reduce both conduction and switching losses. The reduced total losses make this product ideal for high efficiency DC-DC converters that power the latest generation of processors operating at higher frequencies. The IRF6601 has been optimized for parameters that are critical in synchronous buck converters including R_{ds(on)}, gate charge and C_{dv/dt}-induced turn on immunity. The IRF6601 offers particularly low R_{ds(on)} and high C_{dv/dt} immunity for synchronous FET applications.

Absolute Maximum Ratings

	Parameter	Max.	Units
V _{DS}	Drain- Source Voltage	20	V
I _D @ T _C = 25°C	Continuous Drain Current, V _{GS} @ 10V	85	A
I _D @ T _A = 25°C	Continuous Drain Current, V _{GS} @ 10V	26	
I _D @ T _A = 70°C	Continuous Drain Current, V _{GS} @ 10V	20	
I _{DM}	Pulsed Drain Current ①	200	
P _D @ T _A = 25°C	Power Dissipation	3.6	W
P _D @ T _A = 70°C	Power Dissipation	2.3	
P _D @ T _C = 25°C	Power Dissipation	42	
	Linear Derating Factor	28	mW/°C
V _{GS}	Gate-to-Source Voltage	±20	V
T _J , T _{STG}	Junction and Storage Temperature Range	-55 to + 150	°C

Thermal Resistance

Symbol	Parameter	Typ.	Max.	Units
R _{θJA}	Junction-to-Ambient③	—	35	°C/W
R _{θJA}	Junction-to-Ambient④	—	12.5	
R _{θJA}	Junction-to-Ambient⑤	—	20	
R _{θJC}	Junction-to-Case⑥	—	3.0	
R _{θJ-PCB}	Junction-to-PCB mounted	—	1.0	

IRF6601

International
IR Rectifier

Static @ T_J = 25°C (unless otherwise specified)

	Parameter	Min.	Typ.	Max.	Units	Conditions
V _{(BR)DSS}	Drain-to-Source Breakdown Voltage	20	—	—	V	V _{GS} = 0V, I _D = 100μA
ΔV _{(BR)DSS/ΔT_J}	Breakdown Voltage Temp. Coefficient	—	0.019	—	V/°C	Reference to 25°C, I _D = 1mA
R _{DS(on)}	Static Drain-to-Source On-Resistance	—	—	3.8	mΩ	V _{GS} = 10V, I _D = 26A
		—	—	5.0		V _{GS} = 4.5V, I _D = 21A ②
V _{GS(th)}	Gate Threshold Voltage	1.0	—	3.0	V	V _{DS} = V _{GS} , I _D = 250μA
I _{DSS}	Drain-to-Source Leakage Current	—	—	20	μA	V _{DS} = 16V, V _{GS} = 0V
		—	—	100		V _{DS} = 16V, V _{GS} = 0V, T _J = 70°C
I _{GSS}	Gate-to-Source Forward Leakage	—	—	100	nA	V _{GS} = 20 V
	Gate-to-Source Reverse Leakage	—	—	-100		V _{GS} = -20 V

Dynamic @ T_J = 25°C (unless otherwise specified)

Symbol	Parameter	Min.	Typ.	Max.	Units	Conditions
g _{fs}	Forward Transconductance	50	—	—	S	V _{DS} = 10 V, I _D = 21 A
Q _g	Total Gate Charge Cont FET	—	36	54	nC	I _D = 21A
Q _{gs}	Gate-to-Source Charge	—	11	—		V _{DS} = 16 V
Q _{gd}	Gate to Drain ("Miller") Charge	—	12	—		V _{GS} = 4.5 V,
Q _{oss}	Output Charge	—	48	—		V _{DS} = 0 V, V _{GS} = 16V
t _{d(on)}	Turn-On Delay Time	—	16	—	ns	V _{DD} = 15 V
t _r	Rise Time	—	140	—		I _D = 21 A
t _{d(off)}	Turn-Off Delay Time	—	33	—		R _G = 5.1 Ω
t _f	Fall Time	—	110	—		V _{GS} = 4.5 V ②
C _{iss}	Input Capacitance	—	3440	—	pF	V _{GS} = 0V
C _{oss}	Output Capacitance	—	2430	—		V _{DS} = 10V
C _{rss}	Reverse Transfer Capacitance	—	380	—		f = 1.0MHz

Avalanche Characteristics

Symbol	Parameter	Typ.	Max.	Units
E _{AS}	Single Pulse Avalanche Energy②	—	65	mJ
I _{AR}	Avalanche Current①	—	21	A

Diode Characteristics

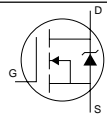
Symbol	Parameter	Min.	Typ.	Max.	Units	Conditions
I _S	Continuous Source Current (Body Diode)	—	—	26	A	MOSFET symbol showing the integral reverse p-n junction diode. 
I _{SM}	Pulsed Source Current (Body Diode) ①	—	—	200		
V _{SD}	Diode Forward Voltage	—	0.83	1.2	V	T _J = 25°C, I _S = 21A, V _{GS} = 0V ②
		—	0.68	—		T _J = 125°C, I _S = 21A, V _{GS} = 0V ②
t _{rr}	Reverse Recovery Time	—	60	90	ns	T _J = 25°C, I _F = 21A, V _R = 15 V
Q _{rr}	Reverse Recovery Charge	—	94	140		di/dt = 100A/μs ②
t _{rr}	Reverse Recovery Time	—	62	93	ns	T _J = 125°C, I _F = 21A, V _R = 15 V
Q _{rr}	Reverse Recovery Charge	—	88	130		di/dt = 100A/μs ②

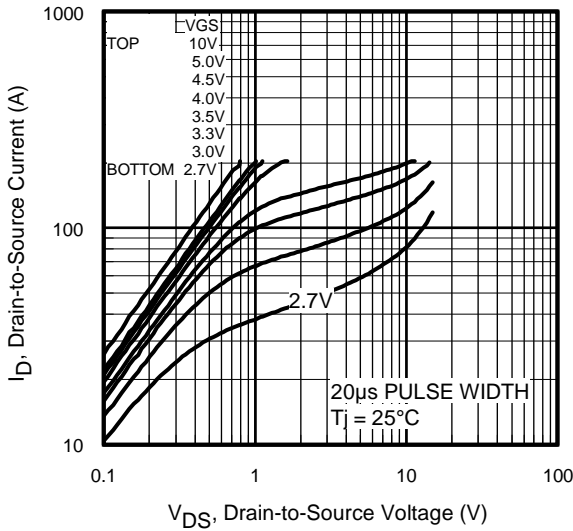

Fig 1. Typical Output Characteristics

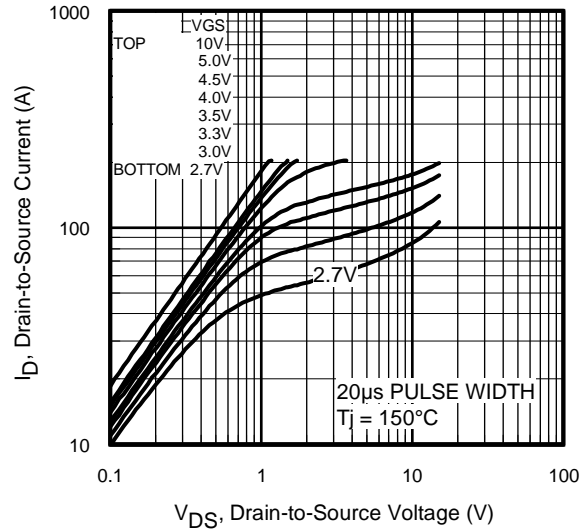

Fig 2. Typical Output Characteristics

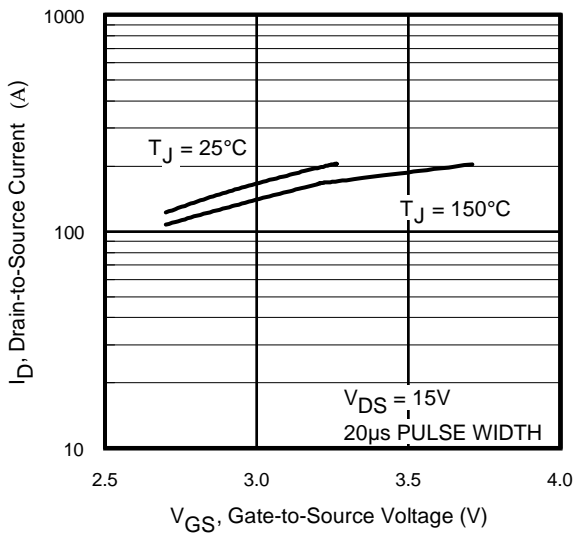

Fig 3. Typical Transfer Characteristics

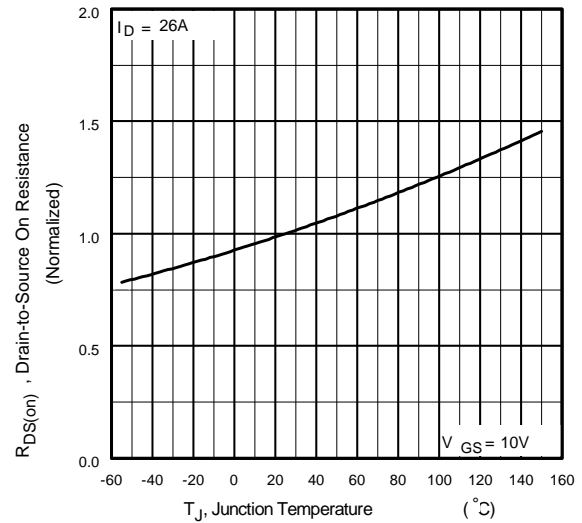

Fig 4. Normalized On-Resistance Vs. Temperature

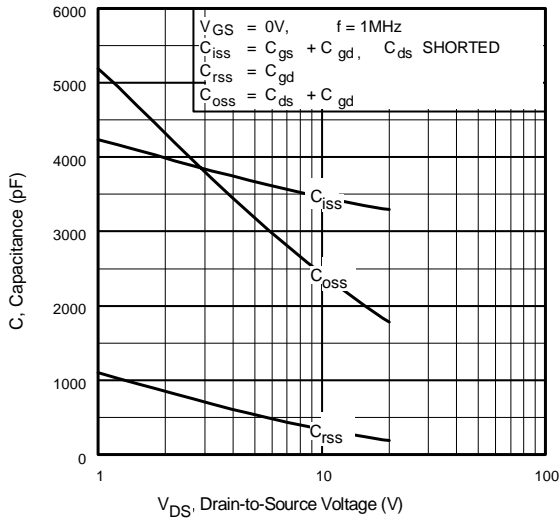

Fig 5. Typical Capacitance Vs. Drain-to-Source Voltage

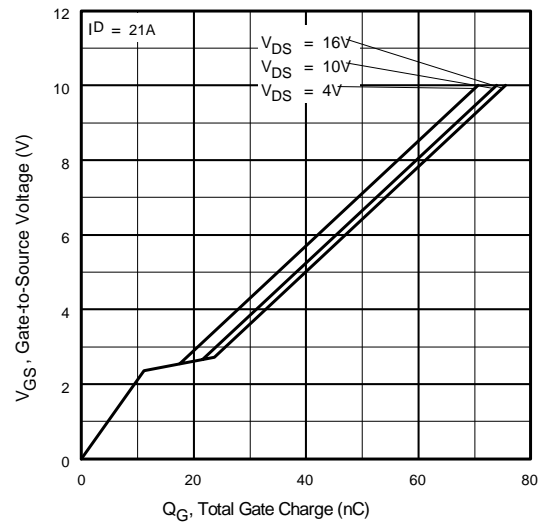

Fig 6. Typical Gate Charge Vs. Gate-to-Source Voltage

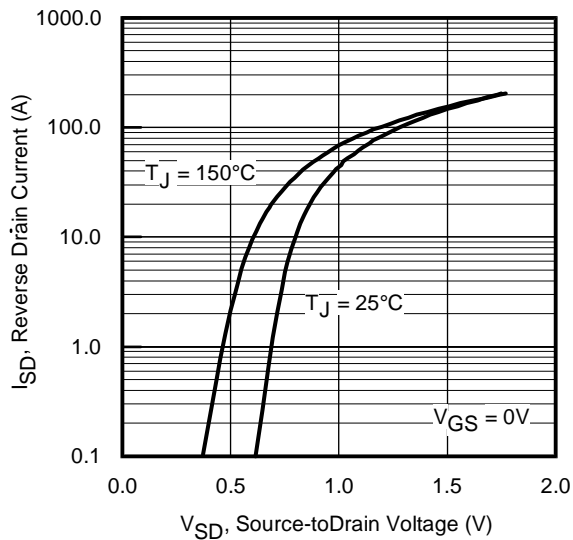

Fig 7. Typical Source-Drain Diode Forward Voltage

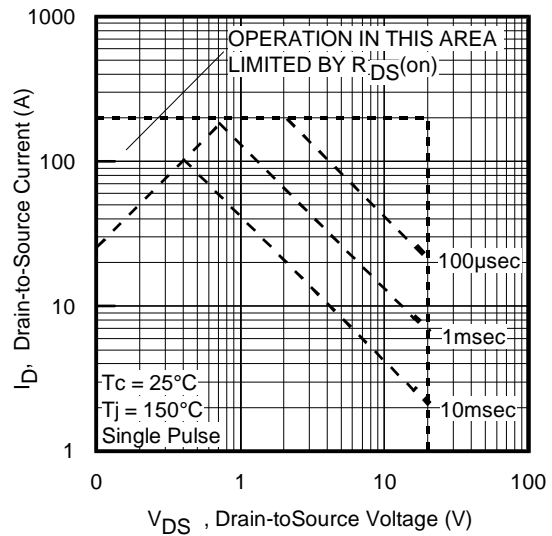

Fig 8. Maximum Safe Operating Area

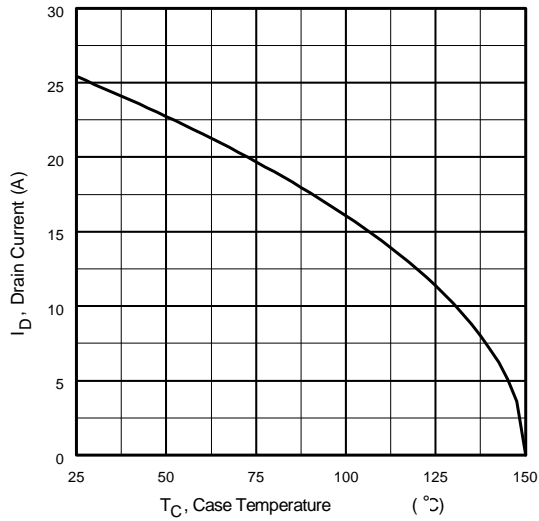

Fig 9. Maximum Drain Current Vs. Ambient Temperature

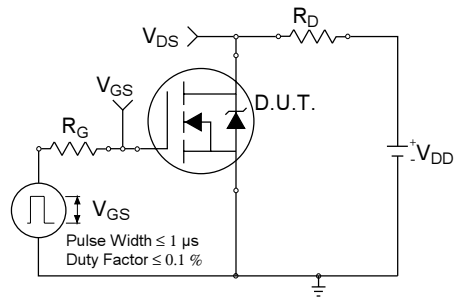

Fig 10a. Switching Time Test Circuit

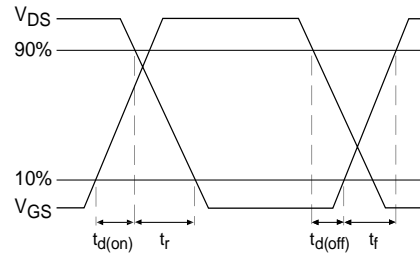

Fig 10b. Switching Time Waveforms

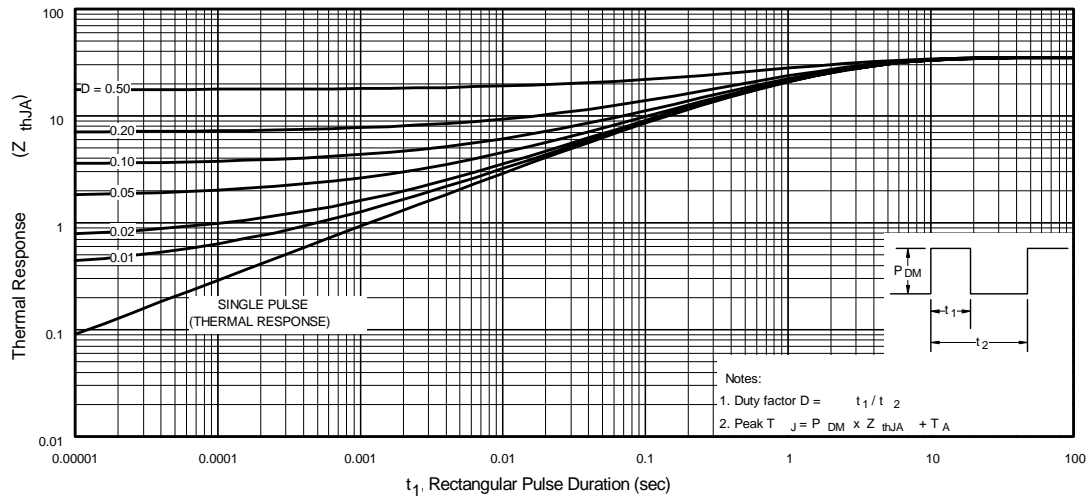

Fig 10. Maximum Effective Transient Thermal Impedance, Junction-to-Ambient

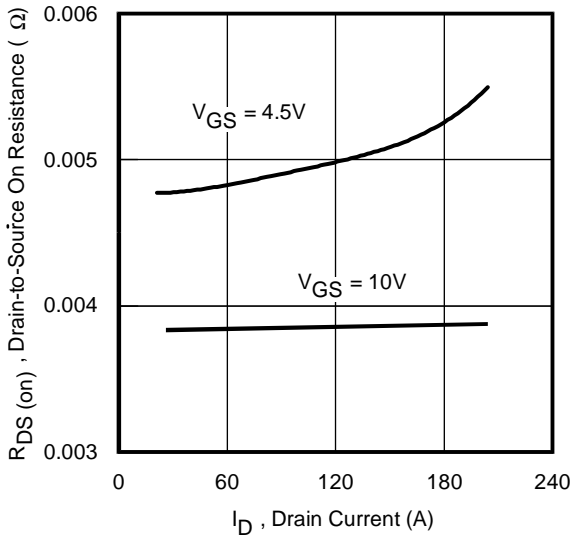

Fig 12. On-Resistance Vs. Drain Current

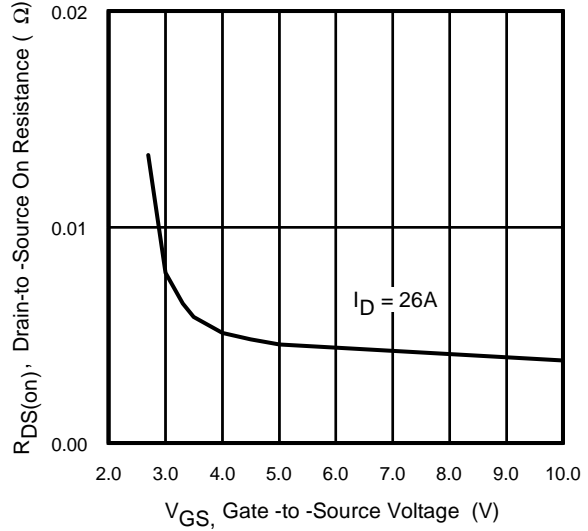

Fig 13. On-Resistance Vs. Gate Voltage

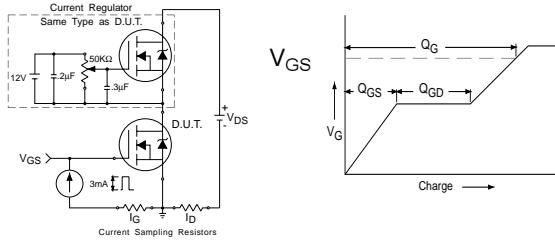

Fig 13a&b. Basic Gate Charge Test Circuit and Waveform

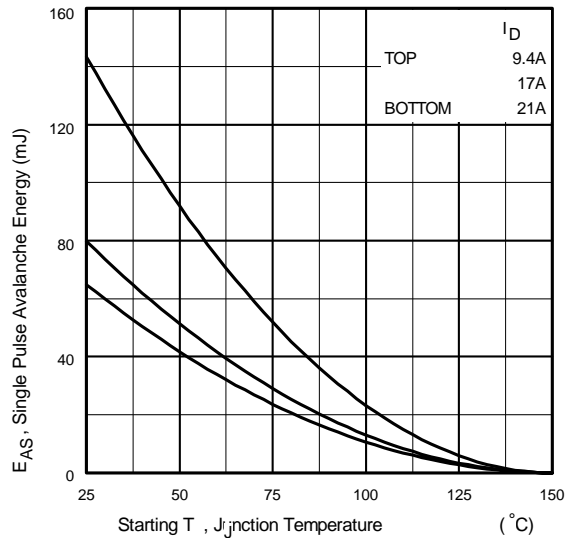

Fig 14c. Maximum Avalanche Energy Vs. Drain Current

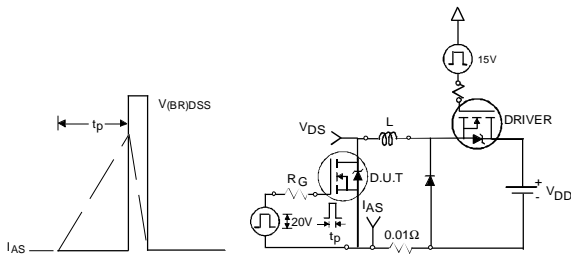
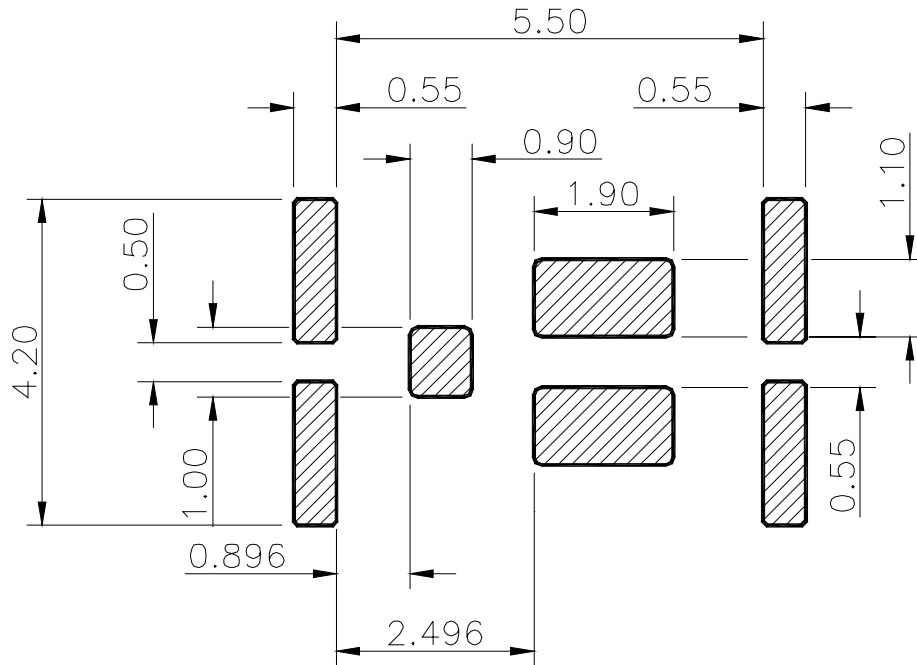
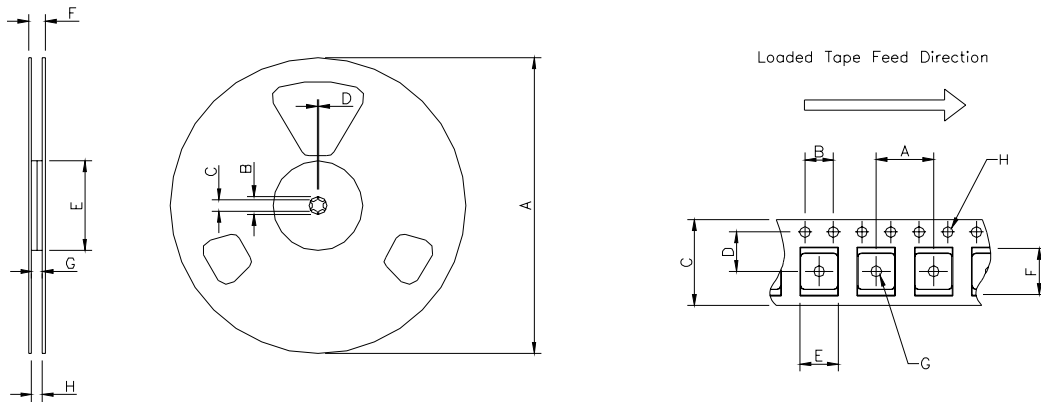

Fig 14a&b. Unclamped Inductive Test circuit and Waveforms

DirectFET™ Board Footprint



DirectFET™ Tape and Reel Dimension



Note: Controlling dimensions are in mm

CODE	DIMENSIONS		DIMENSIONS	
	MIN	MAX	MIN	MAX
A	330.0	N.C	12.992	N.C
B	20.2	N.C	0.795	N.C
C	12.8	13.2	0.504	0.520
D	1.5	N.C	0.059	N.C
E	100.0	N.C	3.937	N.C
F	N.C	18.4	N.C	0.724
G	12.4	14.4	0.488	0.567
H	11.9	15.4	0.469	0.606

Note: Controlling dimensions in mm

CODE	DIMENSIONS		DIMENSIONS	
	MIN	MAX	MIN	MAX
A	7.90	8.10	0.311	0.319
B	3.90	4.10	0.154	0.161
C	11.90	12.30	0.469	0.484
D	5.45	5.55	0.215	0.219
E	5.10	5.30	0.201	0.209
F	6.50	6.70	0.256	0.264
G	1.50	N.C	0.059	N.C
H	1.50	1.60	0.059	0.063

IRF6601

International
IR Rectifier

DirectFET™ Outline Dimension

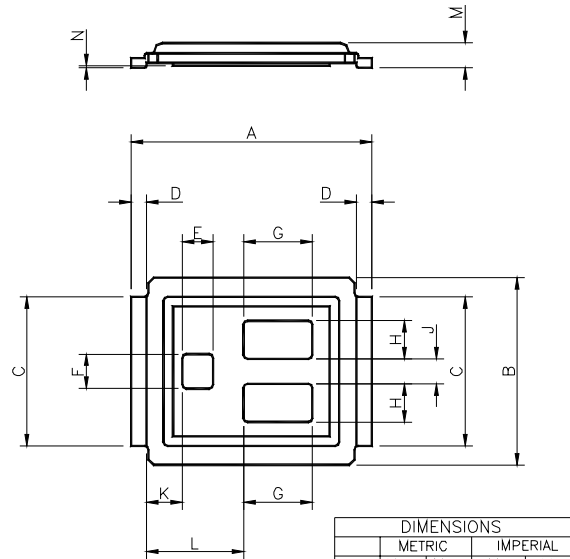

Note: Controlling dimensions are in mm

CODE	METRIC		IMPERIAL	
	MIN	MAX	MIN	MAX
A	6.25	6.35	0.246	0.250
B	4.80	5.05	0.189	0.201
C	3.85	3.95	0.152	0.156
D	0.35	0.45	0.014	0.018
E	0.78	0.82	0.031	0.032
F	0.88	0.92	0.035	0.036
G	1.78	1.82	0.070	0.072
H	0.98	1.02	0.039	0.040
J	0.63	0.67	0.025	0.026
K	0.88	1.01	0.035	0.039
L	2.46	2.63	0.097	0.104
M	0.59	0.70	0.023	0.028
N	0.03	0.08	0.001	0.003

Notes:

- ① Repetitive rating; pulse width limited by max. junction temperature.
- ② Pulse width $\leq 400\mu\text{s}$; duty cycle $\leq 2\%$.
- ③ Surface mounted on 1 in square Cu board
- ④ Used double sided cooling, mounting pad
- ⑤ Mounted on minimum footprint full size board with metalized back and with small clip heatsink
- ⑥ T_C measured with thermal couple mounted to top (Drain) of part.
- ⑦ Starting $T_J = 25^\circ\text{C}$, $L = 0.30\text{mH}$, $R_G = 25\text{W}$, $I_{AS} = 21\text{A}$. (See Figure 14)

Data and specifications subject to change without notice.
This product has been designed and qualified for the consumer market.
Qualification Standards can be found on IR's Web site.

International
IR Rectifier

IR WORLD HEADQUARTERS: 233 Kansas St., El Segundo, California 90245, USA Tel: (310) 252-7105
TAC Fax: (310) 252-7903

Visit us at www.irf.com for sales contact information.03/02

www.irf.com