

IRF6602

DirectFET™ Power MOSFET

- Application Specific MOSFETs
- Ideal for CPU Core DC-DC Converters
- Low Conduction Losses
- Low Switching Losses
- Low Profile (<0.7 mm)
- Dual Sided Cooling Compatible
- Compatible with existing Surface Mount Techniques

V_{DSS}	$R_{DS(on) \text{ max}}$	I_D
20V	13mΩ@ $V_{GS} = 10V$	11A
	19mΩ@ $V_{GS} = 4.5V$	8.8A

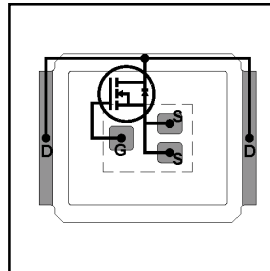

Description

The IRF6602 combines the latest HEXFET® Power MOSFET Silicon technology with the advanced DirectFET™ packaging to achieve the lowest on-state resistance charge product in a package that has the footprint of an SO-8 and only 0.7 mm profile. The DirectFET package is compatible with existing layout geometries used in power applications, PCB assembly equipment and vapor phase, infra-red or convection soldering techniques. The DirectFET package allows dual sided cooling to maximize thermal transfer in power systems, IMPROVING previous best thermal resistance by 80%.

The IRF6602 balances both low resistance and low charge along with ultra low package inductance to reduce both conduction and switching losses. The reduced total losses make this product ideal for high efficiency DC-DC converters that power the latest generation of processors operating at higher frequencies. The IRF6602 has been optimized for parameters that are critical in synchronous buck converters including $R_{ds(on)}$ and gate charge to minimize losses in the control FET socket.

Absolute Maximum Ratings

	Parameter	Max.	Units
V_{DS}	Drain- Source Voltage	20	V
$I_D @ T_C = 25^\circ C$	Continuous Drain Current, $V_{GS} @ 4.5V$	11	A
$I_D @ T_C = 70^\circ C$	Continuous Drain Current, $V_{GS} @ 4.5V$	8.8	
I_{DM}	Pulsed Drain Current ①	88	
$P_D @ T_C = 25^\circ C$	Power Dissipation	2.3	W
$P_D @ T_C = 70^\circ C$	Power Dissipation	1.5	
	Linear Derating Factor	18	mW/°C
V_{GS}	Gate-to-Source Voltage	± 20	V
T_J, T_{STG}	Junction and Storage Temperature Range	-55 to + 150	°C

Thermal Resistance

Symbol	Parameter	Typ.	Max.	Units
$R_{\theta JA}$	Junction-to-Ambient③	—	55	°C/W
$R_{\theta JA}$	Junction-to-Ambient④	12.5	—	
$R_{\theta JA}$	Junction-to-Ambient⑤	20	—	
$R_{\theta JC}$	Junction-to-Case⑥	3.0	—	
$R_{\theta J-PCB}$	Junction-to-PCB mounted	1.0	—	

Static @ T_J = 25°C (unless otherwise specified)

	Parameter	Min.	Typ.	Max.	Units	Conditions
V _{(BR)DSS}	Drain-to-Source Breakdown Voltage	20	—	—	V	V _{GS} = 0V, I _D = 250μA
ΔV _{(BR)DSS/ΔT_J}	Breakdown Voltage Temp. Coefficient	—	0.022	—	V/°C	Reference to 25°C, I _D = 1mA
R _{DS(on)}	Static Drain-to-Source On-Resistance	—	10	13	mΩ	V _{GS} = 10V, I _D = 11A ③
		—	14	19		V _{GS} = 4.5V, I _D = 8.8A ③
V _{GS(th)}	Gate Threshold Voltage	1.0	—	3.0	V	V _{DS} = V _{GS} , I _D = 250μA
I _{DSS}	Drain-to-Source Leakage Current	—	—	20	μA	V _{DS} = 16V, V _{GS} = 0V
		—	—	125		V _{DS} = 16V, V _{GS} = 0V, T _J = 125°C
I _{GSS}	Gate-to-Source Forward Leakage	—	—	200	nA	V _{GS} = 20V
	Gate-to-Source Reverse Leakage	—	—	-200		V _{GS} = -20V

Dynamic @ T_J = 25°C (unless otherwise specified)

Symbol	Parameter	Min.	Typ.	Max.	Units	Conditions
g _{fs}	Forward Transconductance	20	—	—	S	V _{DS} = 10V, I _D = 8.8A
Q _g	Total Gate Charge Cont FET	—	13	20	nC	V _{GS} = 5.0V, V _{DS} = 10V, I _D = 8.8A
Q _g	Total Gate Charge Sync FET	—	11	—		V _{GS} = 5.0V, V _{DS} < 100mV
Q _{gs1}	Pre-V _{th} Gate-Source Charge	—	3.5	—		V _{DS} = 16V, I _D = 8.8A
Q _{gs2}	Post-V _{th} Gate-Source Charge	—	1.3	—		
Q _{gd}	Gate to Drain Charge	—	4.8	—		
Q _{sw}	Switch Charge (Q _{gs2} + Q _{gd})	—	6.1	—		
Q _{oss}	Output Charge	—	19	—		V _{DS} = 16V, V _{GS} = 0V
t _{d(on)}	Turn-On Delay Time	—	11	—		ns
t _r	Rise Time	—	58	—	I _D = 8.8A	
t _{d(off)}	Turn-Off Delay Time	—	15	—	R _G = 1.8Ω	
t _f	Fall Time	—	5.5	—	V _{GS} = 4.5V ③	
C _{iss}	Input Capacitance	—	1420	—	pF	V _{GS} = 0V
C _{oss}	Output Capacitance	—	960	—		V _{DS} = 10V
C _{rss}	Reverse Transfer Capacitance	—	100	—		f = 1.0MHz

Avalanche Characteristics

Symbol	Parameter	Typ.	Max.	Units
E _{AS}	Single Pulse Avalanche Energy②	—	97	mJ
I _{AR}	Avalanche Current①	—	8.8	A

Diode Characteristics

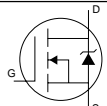
Symbol	Parameter	Min.	Typ.	Max.	Units	Conditions
I _S	Continuous Source Current (Body Diode)	—	—	11	A	MOSFET symbol showing the integral reverse p-n junction diode. 
I _{SM}	Pulsed Source Current (Body Diode) ①	—	—	88		
V _{SD}	Diode Forward Voltage	—	0.83	1.2	V	T _J = 25°C, I _S = 8.8A, V _{GS} = 0V ③
		—	0.65	—		T _J = 125°C, I _S = 8.8A, V _{GS} = 0V ③
t _{rr}	Reverse Recovery Time	—	42	62	ns	T _J = 25°C, I _F = 8.8A, V _R = 15V
Q _{rr}	Reverse Recovery Charge	—	51	77	nC	di/dt = 100A/μs ③
t _{rr}	Reverse Recovery Time	—	43	64	ns	T _J = 125°C, I _F = 8.8A, V _R = 15V
Q _{rr}	Reverse Recovery Charge	—	55	82	nC	di/dt = 100A/μs ③

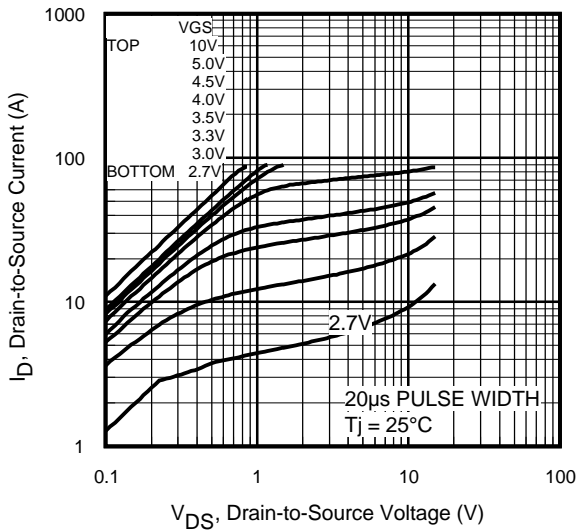

Fig 1. Typical Output Characteristics

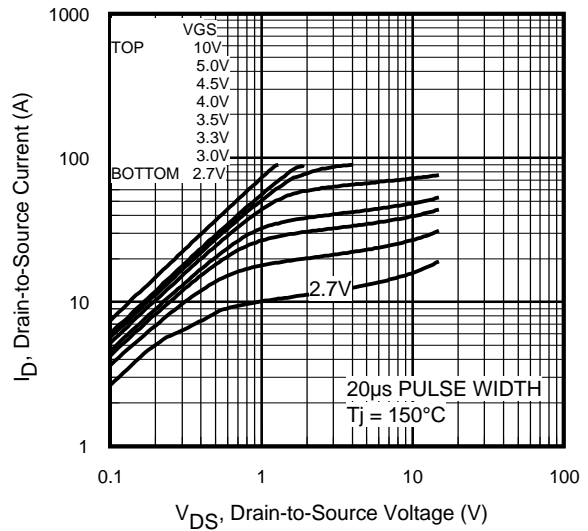

Fig 2. Typical Output Characteristics

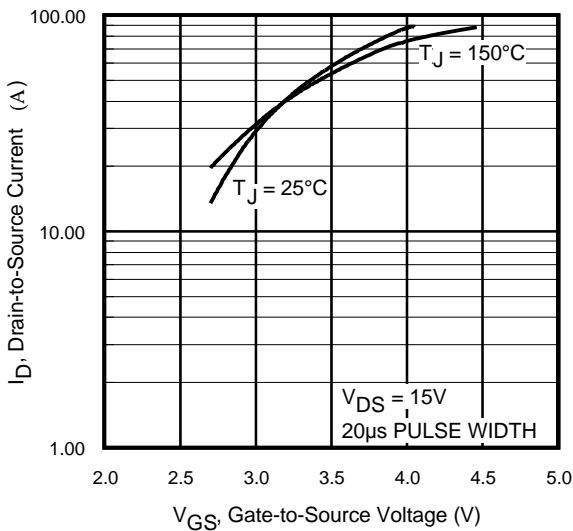

Fig 3. Typical Transfer Characteristics

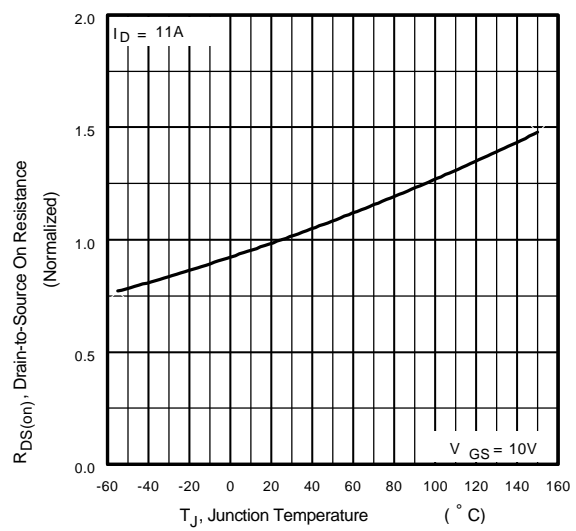

Fig 4. Normalized On-Resistance Vs. Temperature

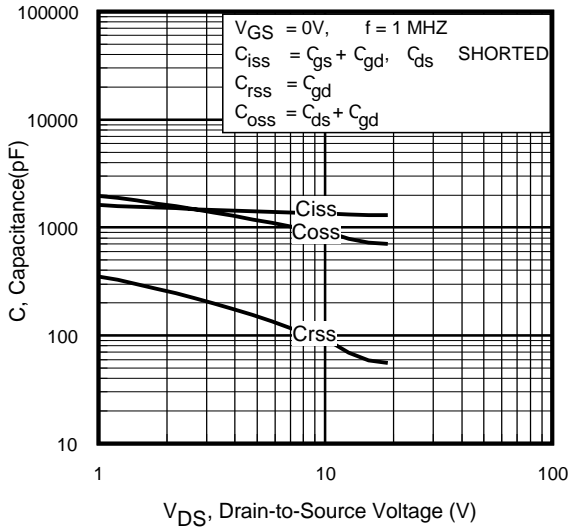

Fig 5. Typical Capacitance Vs. Drain-to-Source Voltage

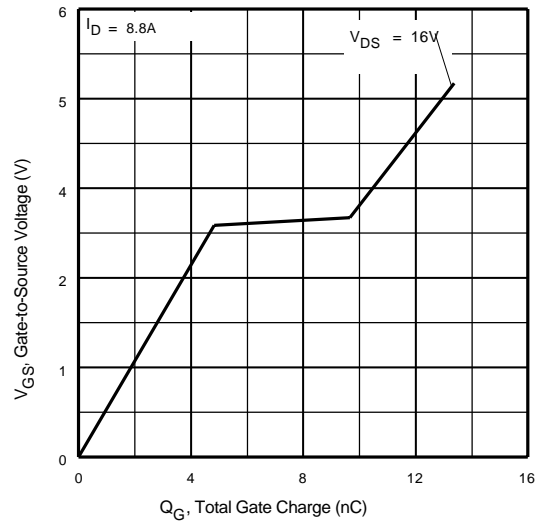

Fig 6. Typical Gate Charge Vs. Gate-to-Source Voltage

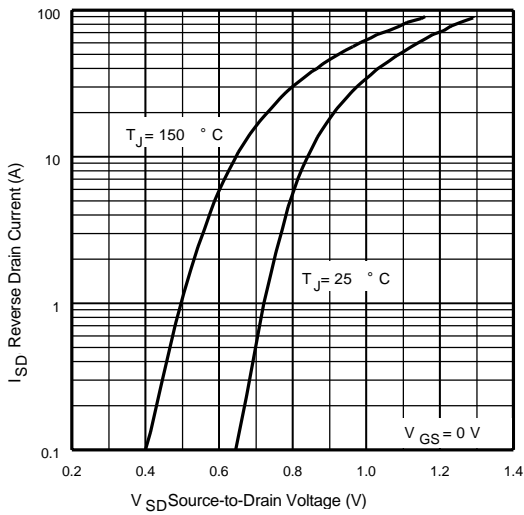

Fig 7. Typical Source-Drain Diode Forward Voltage

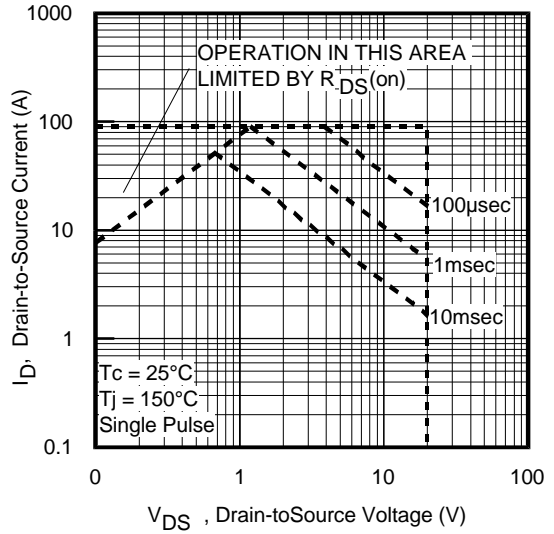

Fig 8. Maximum Safe Operating Area

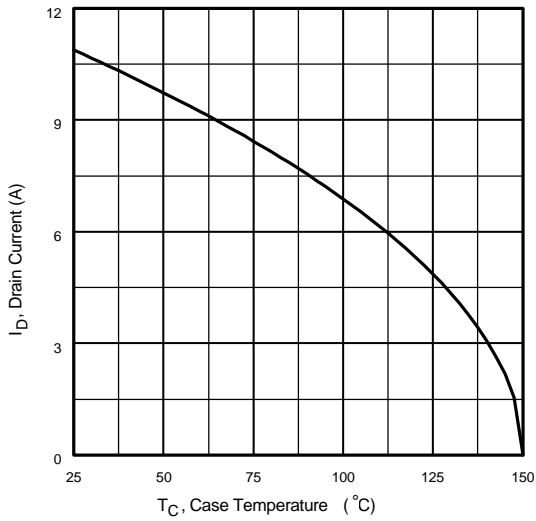

Fig 9. Maximum Drain Current Vs. Ambient Temperature

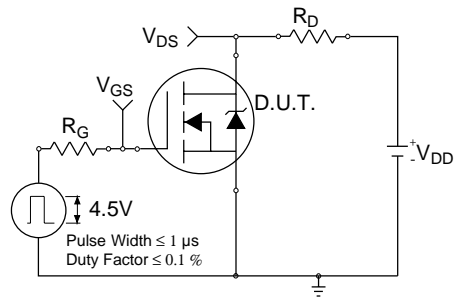

Fig 10a. Switching Time Test Circuit

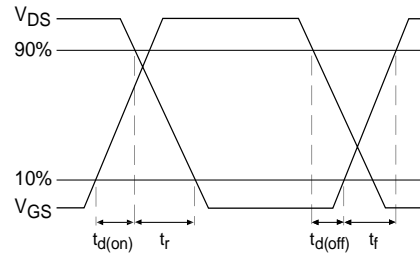

Fig 10b. Switching Time Waveforms

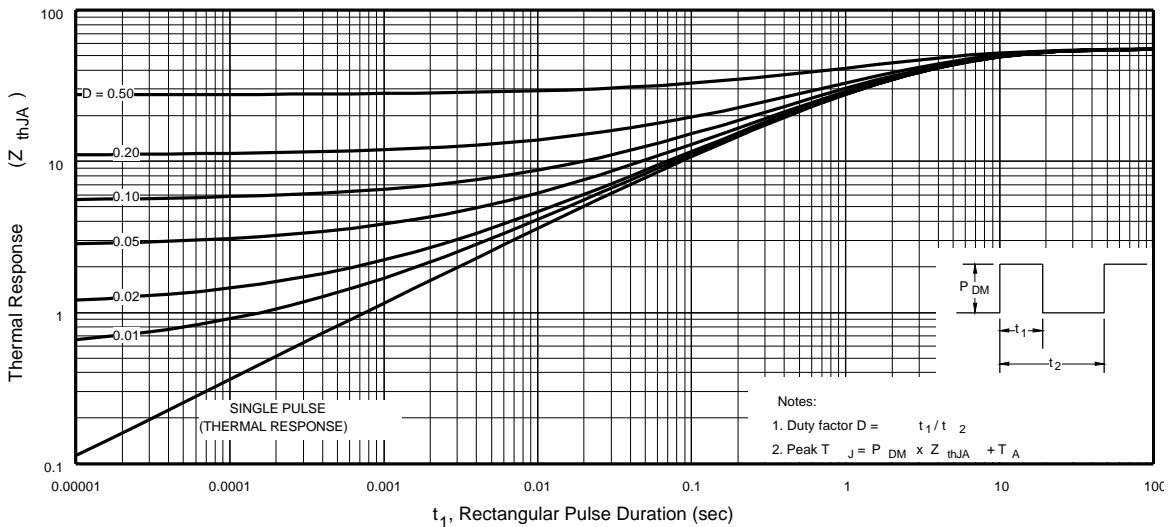

Fig 10. Maximum Effective Transient Thermal Impedance, Junction-to-Case

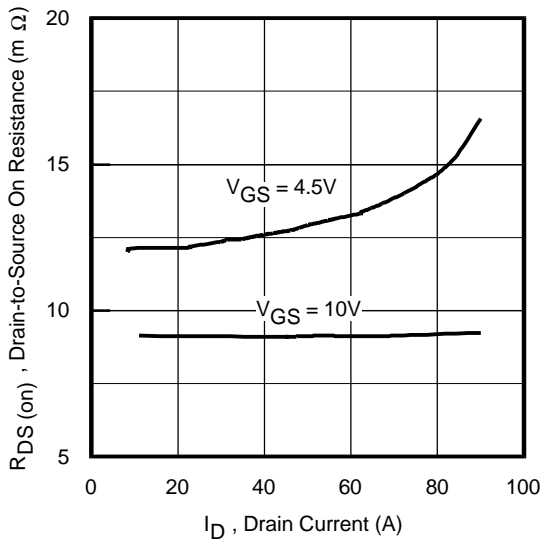

Fig 12. On-Resistance Vs. Drain Current

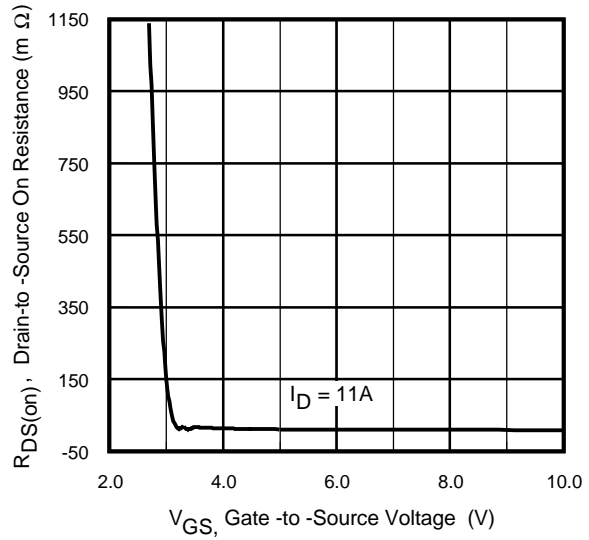

Fig 13. On-Resistance Vs. Gate Voltage

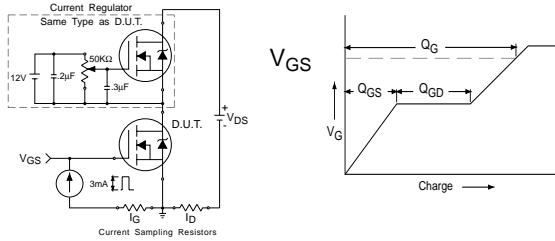

Fig 13a&b. Basic Gate Charge Test Circuit and Waveform

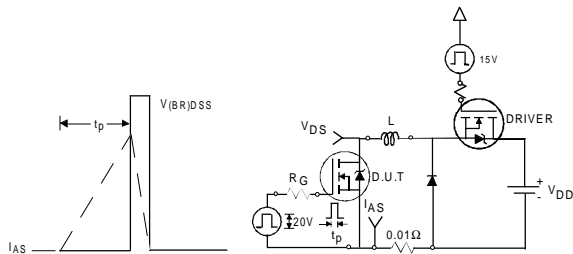

Fig 14a&b. Unclamped Inductive Test circuit and Waveforms

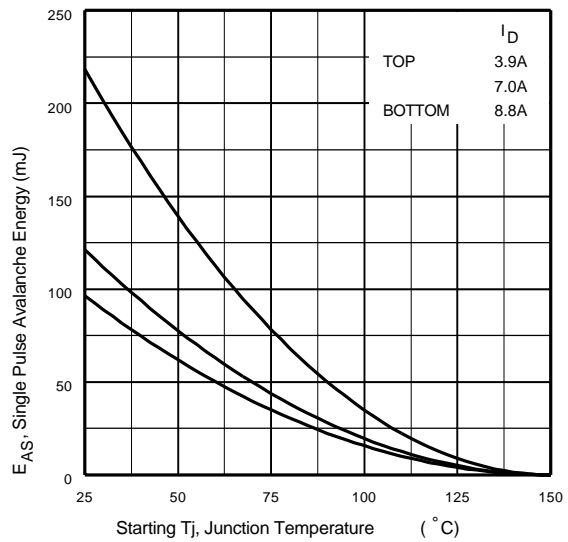
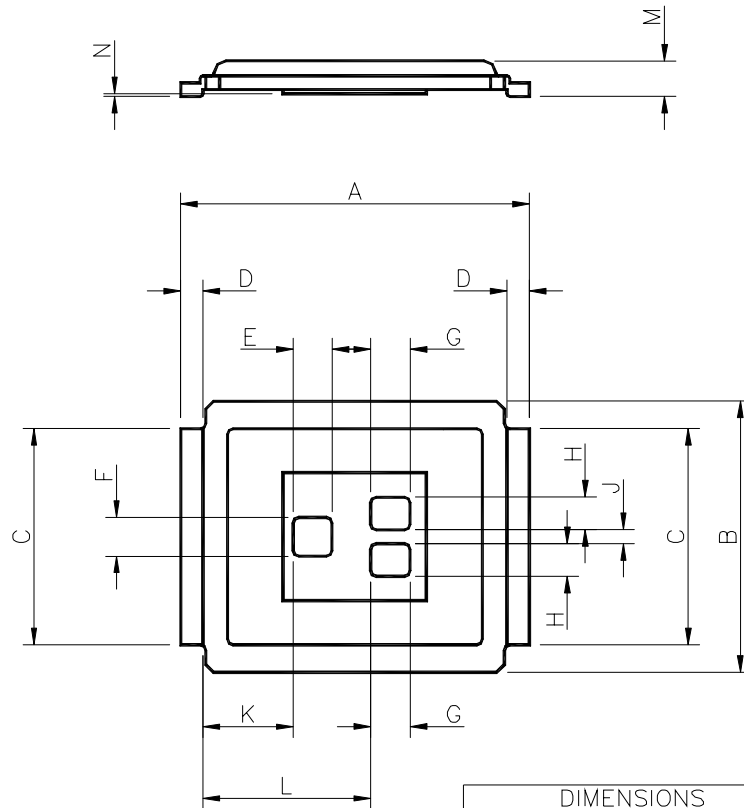

Fig 14c. Maximum Avalanche Energy Vs. Drain Current

DirectFET™ Outline Dimension



±: Controlling dimensions
 0.1 mm

CODE	METRIC		IMPERIAL	
	MIN	MAX	MIN	MAX
A	6.25	6.35	0.246	0.250
B	4.80	5.05	0.189	0.201
C	3.85	3.95	0.152	0.156
D	0.35	0.45	0.014	0.018
E	0.68	0.72	0.027	0.028
F	0.68	0.72	0.027	0.028
G	0.69	0.73	0.027	0.029
H	0.57	0.61	0.022	0.024
J	0.23	0.27	0.009	0.011
K	1.57	1.70	0.062	0.067
L	2.95	3.12	0.116	0.123
M	0.59	0.70	0.023	0.028
N	0.03	0.08	0.001	0.003

IRF6602

International
IR Rectifier

DirectFET™ PCB Footprint

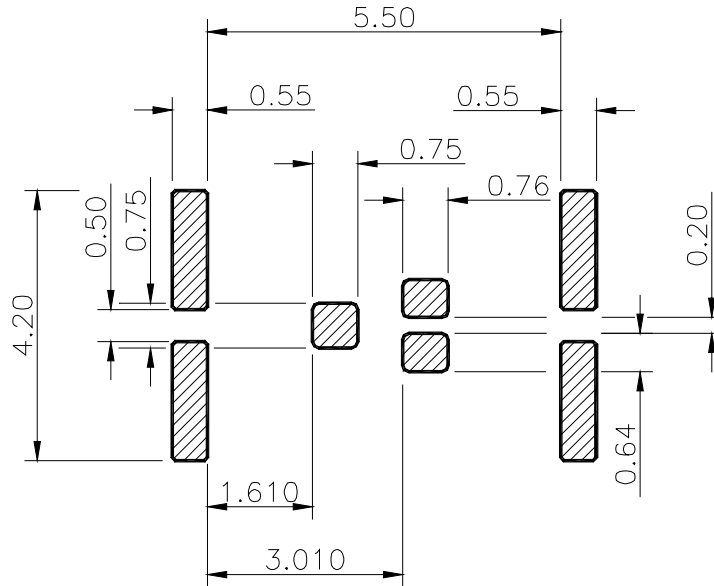

DirectFET™ Tape and Reel Dimension

Loaded Tape Feed Direction

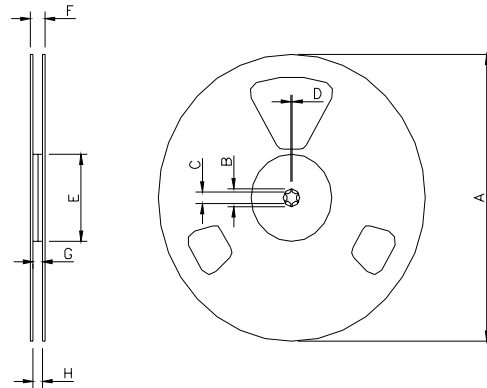
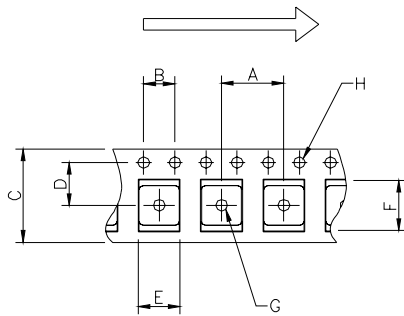

Note: Controlling dimensions in mm

CODE	METRIC		IMPERIAL	
	MIN	MAX	MIN	MAX
A	7.90	8.10	0.311	0.319
B	3.90	4.10	0.154	0.161
C	11.90	12.30	0.469	0.484
D	5.45	5.55	0.215	0.219
E	5.10	5.30	0.201	0.209
F	6.50	6.70	0.256	0.264
G	1.50	N.C	0.059	N.C
H	1.50	1.60	0.059	0.063

Note: Controlling dimensions are in mm

CODE	METRIC		IMPERIAL	
	MIN	MAX	MIN	MAX
A	330.0	N.C	12.992	N.C
B	20.2	N.C	0.795	N.C
C	12.8	13.2	0.504	0.520
D	1.5	N.C	0.059	N.C
E	100.0	N.C	3.937	N.C
F	N.C	18.4	N.C	0.724
G	12.4	14.4	0.488	0.567
H	11.9	15.4	0.469	0.606

DirectFET™ Part Marking

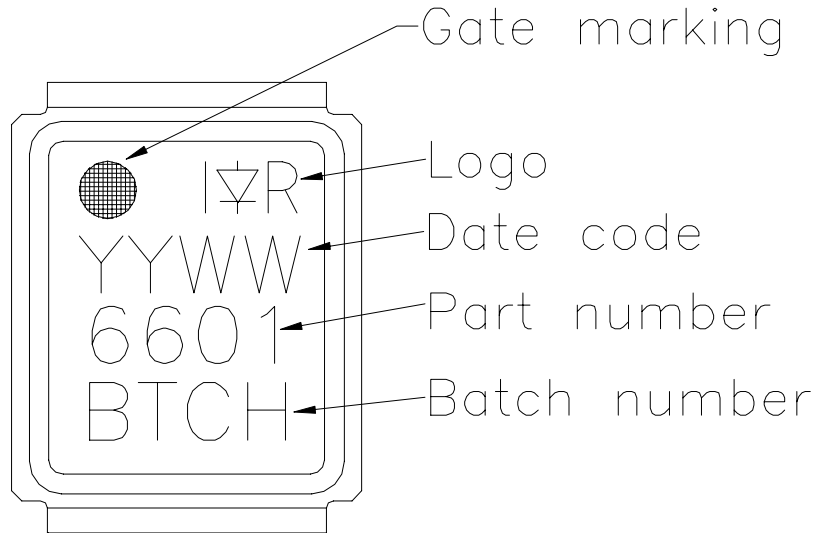

Notes:

- ① Repetitive rating; pulse width limited by max. junction temperature.
- ② Pulse width $\leq 400\mu\text{s}$; duty cycle $\leq 2\%$.
- ③ Surface mounted on 1 in square Cu board.
- ④ Used double sided cooling, mounting pad.
- ⑤ Mounted on minimum footprint full size board with metalized back and with small clip heatsink.
- ⑥ T_C measured with thermal couple mounted to top (Drain) of part.
- ⑦ Starting $T_J = 25^\circ\text{C}$, $L = 2.5\text{mH}$, $R_G = 25\Omega$, $I_{AS} = 8.8\text{A}$. (See Figure 14)

Data and specifications subject to change without notice.
This product has been designed and qualified for the Consumer market.
Qualification Standards can be found on IR's Web site.

International
IR Rectifier

IR WORLD HEADQUARTERS: 233 Kansas St., El Segundo, California 90245, USA Tel: (310) 252-7105
TAC Fax: (310) 252-7903

Visit us at www.irf.com for sales contact information.04/02