

4N35X, 4N36X, 4N37X,  
4N35, 4N36, 4N37,



**OPTICALLY COUPLED  
ISOLATOR  
PHOTOTRANSISTOR OUTPUT**

**APPROVALS**

- UL recognised, File No. E91231

**'X' SPECIFICATION APPROVALS**

- VDE 0884 in 3 available lead forms : -  
- STD  
- G form  
- SMD approved to CECC 00802
- EN60950 approval pending

**DESCRIPTION**

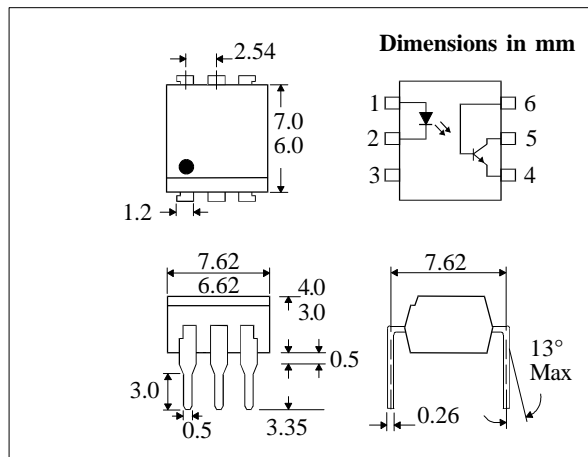
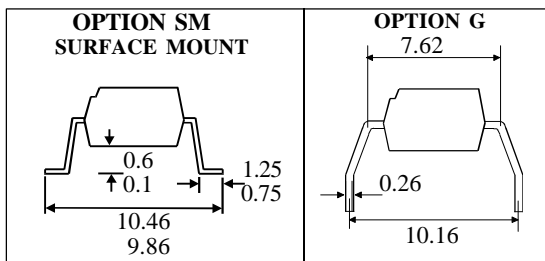
The 4N35, 4N36, 4N37 series of optically coupled isolators consist of infrared light emitting diode and NPN silicon photo transistor in a standard 6 pin dual in line plastic package.

**FEATURES**

- Options :-  
10mm lead spread - add G after part no.  
Surface mount - add SM after part no.  
Tape&reel - add SMT&R after part no.
- High Current Transfer Ratio (100% min.)
- High Isolation Voltage (5.3kV<sub>RMS</sub>, 7.5kV<sub>PK</sub>)
- All electrical parameters 100% tested
- Custom electrical selections available

**APPLICATIONS**

- DC motor controllers
- Industrial systems controllers
- Measuring instruments
- Signal transmission between systems of different potentials and impedances



**ABSOLUTE MAXIMUM RATINGS  
(25°C unless otherwise specified)**

Storage Temperature \_\_\_\_\_ -55°C to + 150°C  
Operating Temperature \_\_\_\_\_ -55°C to + 100°C  
Lead Soldering Temperature  
(1/16 inch (1.6mm) from case for 10 secs) 260°C

**INPUT DIODE**

Forward Current \_\_\_\_\_ 60mA  
Reverse Voltage \_\_\_\_\_ 6V  
Power Dissipation \_\_\_\_\_ 105mW

**OUTPUT TRANSISTOR**

Collector-emitter Voltage  $BV_{CEO}$  \_\_\_\_\_ 30V  
Collector-base Voltage  $BV_{CBO}$  \_\_\_\_\_ 70V  
Emitter-collector Voltage  $BV_{ECO}$  \_\_\_\_\_ 6V  
Power Dissipation \_\_\_\_\_ 160mW

**POWER DISSIPATION**

Total Power Dissipation \_\_\_\_\_ 200mW  
(derate linearly 2.67mW/°C above 25°C)

**ISOCOM COMPONENTS LTD**  
Unit 25B, Park View Road West,  
Park View Industrial Estate, Brenda Road  
Hartlepool, Cleveland, TS25 1YD  
Tel: (01429) 863609 Fax : (01429) 863581

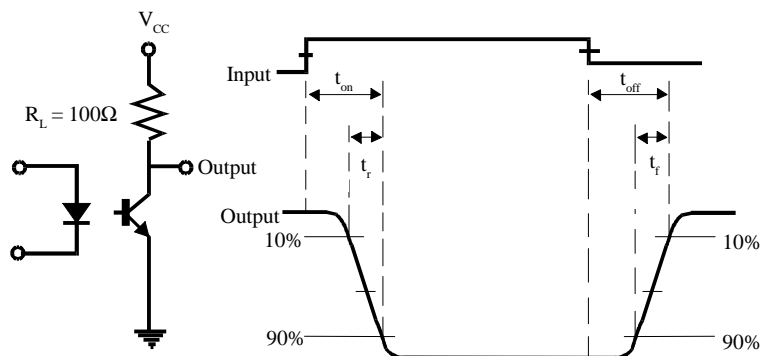
**ISOCOM INC**  
1024 S. Greenville Ave, Suite 240,  
Allen, TX 75002 USA  
Tel: (214) 495-0755 Fax: (214) 495-0901  
e-mail info@isocom.com  
http://www.isocom.com

**ELECTRICAL CHARACTERISTICS (  $T_A = 25^\circ\text{C}$  Unless otherwise noted )**

PARAMETER		MIN	TYP	MAX	UNITS	TEST CONDITION
Input	Forward Voltage ( $V_F$ )		1.2	1.5	V	$I_F = 10\text{mA}$ $I_R = 10\mu\text{A}$ $V_R = 6\text{V}$
	Reverse Voltage ( $V_R$ )	6			V	
	Reverse Current ( $I_R$ )			10	$\mu\text{A}$	
Output	Collector-emitter Breakdown ( $BV_{CEO}$ ) ( Note 2 )	30			V	$I_C = 1\text{mA}$
	Collector-base Breakdown ( $BV_{CBO}$ )	70			V	$I_C = 100\mu\text{A}$
	Emitter-collector Breakdown ( $BV_{ECO}$ )	6			V	$I_E = 100\mu\text{A}$
	Collector-emitter Dark Current ( $I_{CEO}$ )			50	nA	$V_{CE} = 10\text{V}$
	Collector-base Dark Current ( $I_{CBO}$ )			20	nA	$V_{CE} = 10\text{V}$
Coupled	Current Transfer Ratio (CTR)	100			%	$10\text{mA } I_F, 10\text{V } V_{CE}$
	Collector-emitter Saturation Voltage $V_{CE(SAT)}$			0.3	V	$10\text{mA } I_F, 0.5\text{mA } I_C$
	Input to Output Isolation Voltage $V_{ISO}$	5300			$V_{RMS}$	See note 1
		7500			$V_{PK}$	See note 1
	Input-output Isolation Resistance $R_{ISO}$	$5 \times 10^{10}$			$\Omega$	$V_{IO} = 500\text{V}$ (note 1)
	Turn-on Time $t_{on}$		5	10	$\mu\text{s}$	$V_{CC} = 10\text{V},$ $I_C = 2\text{mA}, R_L = 100\Omega$ ( FIG 1 )
	Turn-off Time $t_{off}$		5	10	$\mu\text{s}$	
Output Rise Time $t_r$		3.5		$\mu\text{s}$		
Output Fall Time $t_f$		4.9		$\mu\text{s}$		

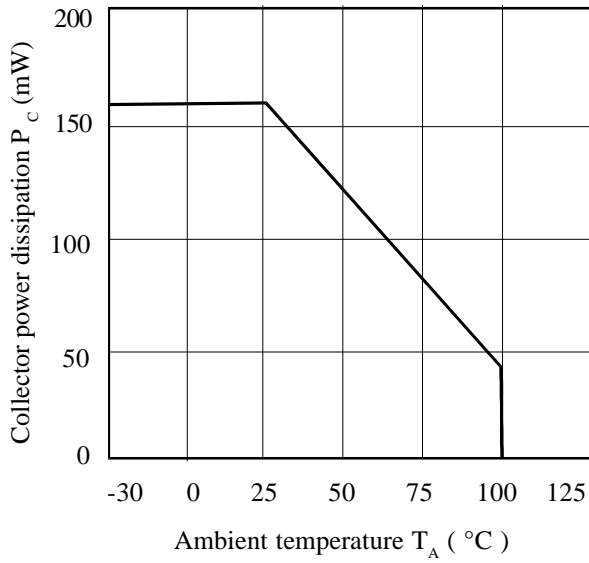
Note 1 Measured with input leads shorted together and output leads shorted together.

Note 2 Special Selections are available on request. Please consult the factory.

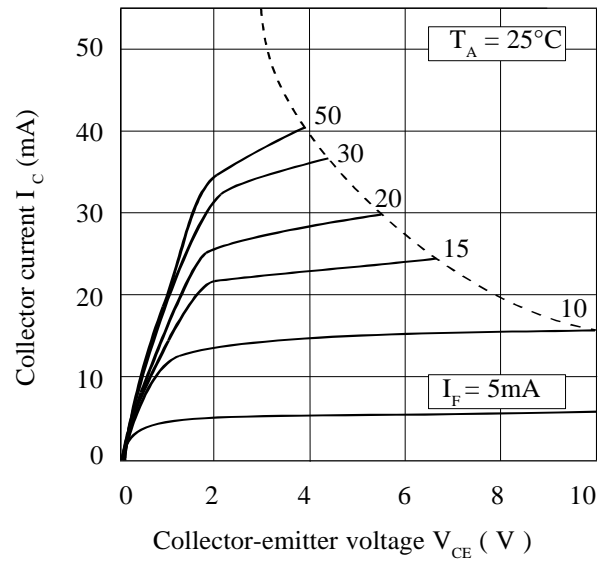


**FIG 1**

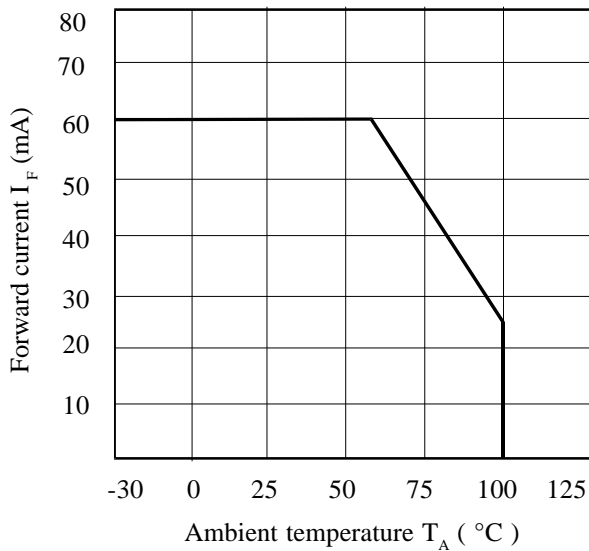
**Collector Power Dissipation vs. Ambient Temperature**



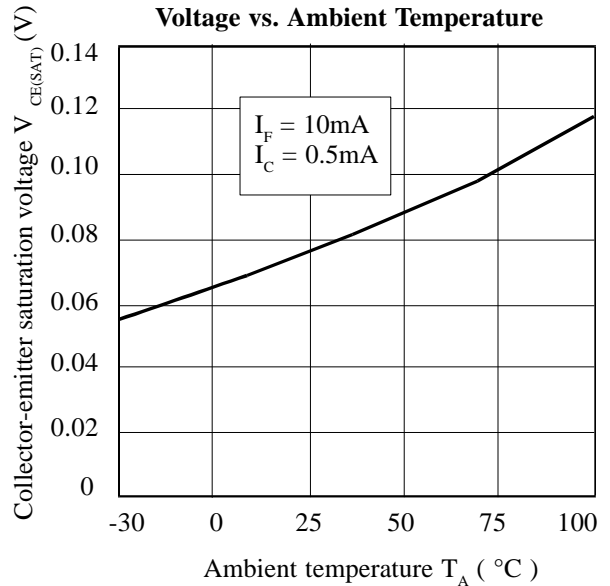
**Collector Current vs. Collector-emitter Voltage**



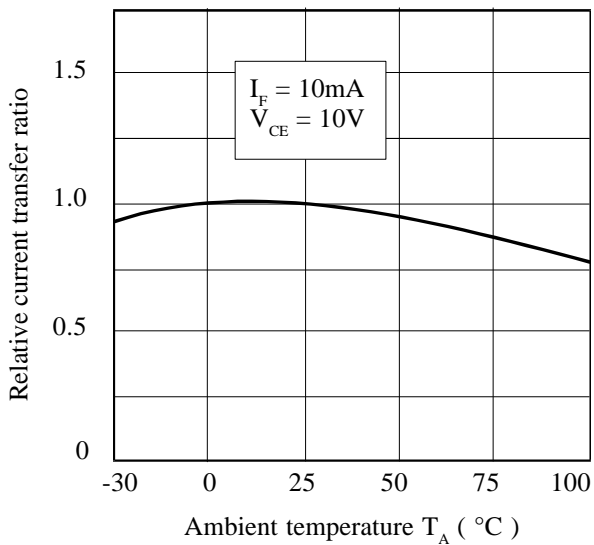
**Forward Current vs. Ambient Temperature**



**Collector-emitter Saturation Voltage vs. Ambient Temperature**



**Relative Current Transfer Ratio vs. Ambient Temperature**



**Relative Current Transfer Ratio vs. Forward Current**

