



**HIGH DENSITY
PHOTOTRANSISTOR OPTICALLY
COUPLED ISOLATORS**

APPROVALS

- UL recognised, File No. E91231
- 'X' SPECIFICATION APPROVALS
- **MCT6** -
VDE 0884 in 3 available lead form : -
- STD
- G form
- SMD approved to CECC 00802
- MCT61, MCT62, MCT66** -
VDE 0884 approval pending
- EN60950 approval pending

DESCRIPTION

The MCT6, MCT61, MCT62 & MCT66 series of optically coupled isolators consist of infrared light emitting diodes and NPN silicon photo transistors in space efficient dual in line plastic packages mounted two channels per unit.

FEATURES

- Options :-
10mm lead spread - add G after part no.
Surface mount - add SM after part no.
Tape&reel - add SMT&R after part no.
- High Isolation Voltage (5.3kV_{RMS}, 7.5kV_{PK})

APPLICATIONS

- Computer terminals
- Industrial systems controllers
- Measuring instruments
- Signal transmission between systems of different potentials and impedances

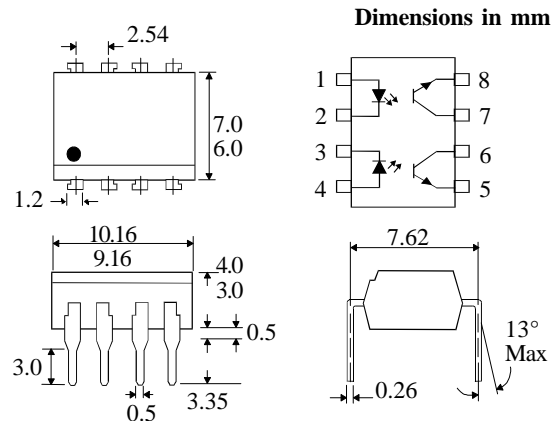

**ABSOLUTE MAXIMUM RATINGS
(25°C unless otherwise specified)**

Storage Temperature _____ -55°C to + 125°C
 Operating Temperature _____ -55°C to + 100°C
 Lead Soldering Temperature
 (1/16 inch (1.6mm) from case for 10 secs) 260°C

INPUT DIODE

Forward Current _____ 50mA
 Reverse Voltage _____ 6V
 Power Dissipation _____ 70mW

OUTPUT TRANSISTOR

Collector-emitter Voltage BV_{CEO} _____ 30V
 Emitter-collector Voltage BV_{ECO} _____ 6V
 Power Dissipation _____ 150mW

POWER DISSIPATION

Total Power Dissipation _____ 200mW
 (derate linearly 2.67mW/°C above 25°C)

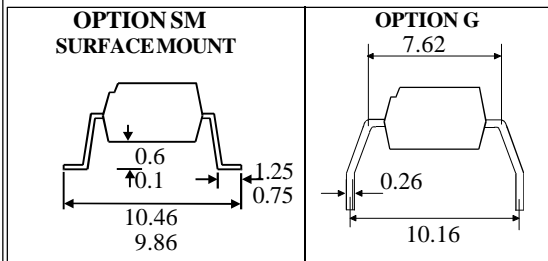

ISOCOM COMPONENTS LTD
 Unit 25B, Park View Road West,
 Park View Industrial Estate, Brenda Road
 Hartlepool, Cleveland, TS25 1YD
 Tel: (01429) 863609 Fax :(01429) 863581

ISOCOM INC
 1024 S. Greenville Ave, Suite 240,
 Allen, TX 75002 USA
 Tel: (214) 495-0755 Fax: (214) 495-0901
 e-mail info@isocom.com
 http://www.isocom.com

ELECTRICAL CHARACTERISTICS ($T_A = 25^\circ\text{C}$ Unless otherwise noted)

PARAMETER		MIN	TYP	MAX	UNITS	TEST CONDITION						
Input	Forward Voltage (V_F)	3		1.50	V	$I_F = 20\text{mA}$ $I_R = 10\mu\text{A}$ $V_R = 3\text{V}$						
	Reverse Voltage (V_R)				V							
	Reverse Current (I_R)			10	μA							
Output	Collector-emitter Breakdown (BV_{CEO})	30			V	$I_C = 1\text{mA}$ (note 2) $I_E = 100\mu\text{A}$ $V_{CE} = 10\text{V}$						
	Emitter-collector Breakdown (BV_{ECO})	6			V							
	Collector-emitter Dark Current (I_{CEO})			100	nA							
Coupled	Current Transfer Ratio (CTR) (Note 2)	5300	2.4									
	MCT6						20	%	$10\text{mA } I_F, 10\text{V } V_{CE}$			
	MCT61						50	%	$5\text{mA } I_F, 5\text{V } V_{CE}$			
	MCT62						100	%	$5\text{mA } I_F, 5\text{V } V_{CE}$			
	MCT66						6	%	$10\text{mA } I_F, 10\text{V } V_{CE}$			
	Collector-emitter Saturation Voltage V_{CESAT}						0.4	V				
	MCT6,61,62											$16\text{mA } I_F, 2\text{mA } I_C$
	MCT66											$40\text{mA } I_F, 2\text{mA } I_C$
	Input to Output Isolation Voltage V_{ISO}						7500			V _{RMS}	See note 1	
	Input to Output Isolation Voltage V_{ISO}						5300			V _{PK}	See note 1	
Input-output Isolation Resistance R_{ISO}	5×10^{10}			Ω	$V_{IO} = 500\text{V}$ (note 1)							
Output Rise Time, Fall Time t_r, t_f		2.4		μs	$I_C = 2\text{mA}, V_{CC} = 10\text{V}, R_L = 100\Omega$ (Fig. 1)							
Output Rise Time, Fall Time t_r, t_f		15		μs	$I_C = 2\text{mA}, V_{CC} = 10\text{V}, R_L = 1\text{k}\Omega$ (Fig. 2)							

Note 1 Measured with input leads shorted together and output leads shorted together.

Note 2 Special Selections are available on request. Please consult the factory.

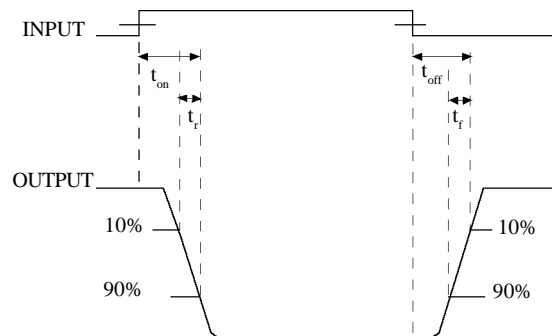
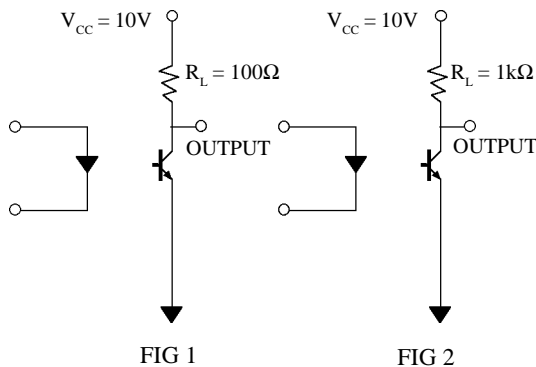

Collector Power Dissipation vs. Ambient Temperature

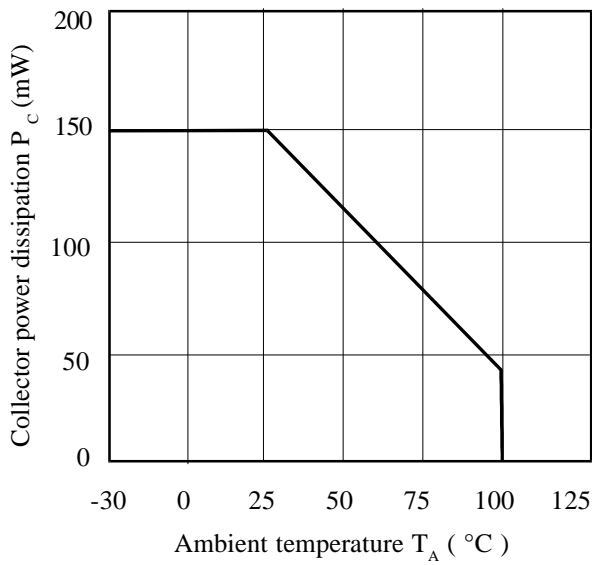

Collector Current vs. Collector-emitter Voltage

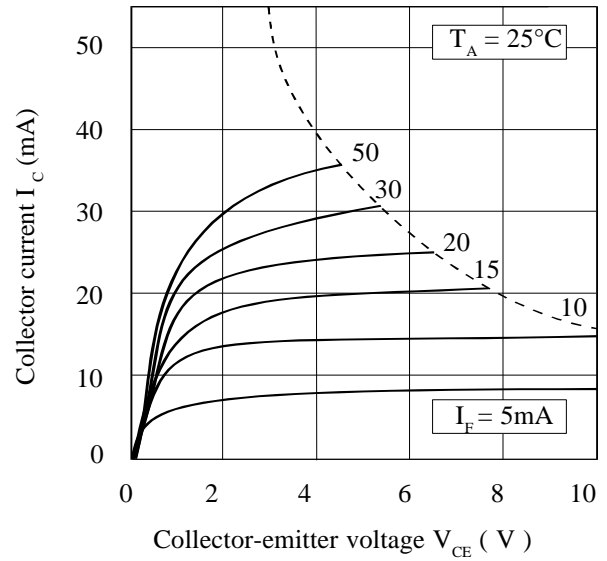

Forward Current vs. Ambient Temperature

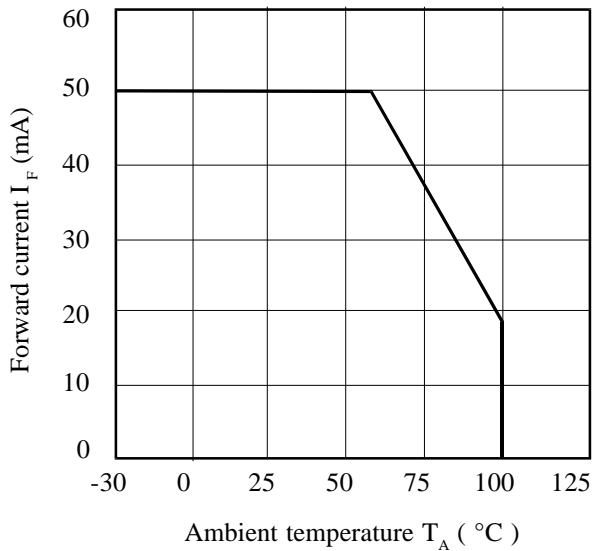

Relative Current Transfer Ratio vs. Forward Current

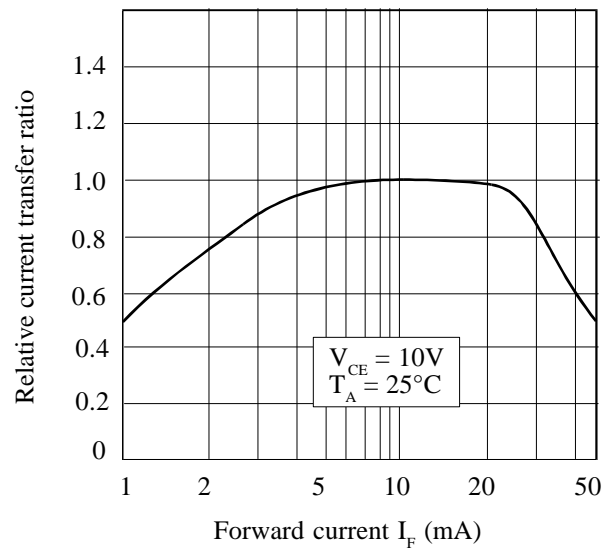

Relative Current Transfer Ratio vs. Ambient Temperature

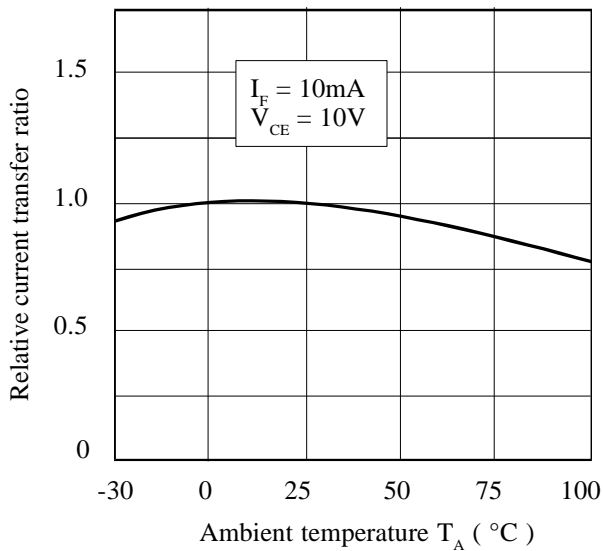

Collector-emitter Saturation Voltage vs. Ambient Temperature

