

SFH620-1X, SFH620-2X, SFH620-3X  
SFH620-1, SFH620-2, SFH620-3



**AC INPUT PHOTOTRANSISTOR  
OPTICALLY COUPLED ISOLATORS**

**APPROVALS**

- UL recognised, File No. E91231
- **'X' SPECIFICATION APPROVALS**
- Certified to EN60950 by the following Test Bodies :-  
Nemko - Certificate No. P96102022  
Fimko - Registration No. 192313-01..25  
Semko - Reference No. 9639052 01  
Demko - Reference No. 305969
- VDE 0884 approval pending

**DESCRIPTION**

The SFH620 series of optically coupled isolators consist of inverse parallel infrared light emitting diodes and NPN silicon photo transistors in space efficient dual in line plastic packages.

**FEATURES**

- Options :-  
10mm lead spread - add G after part no.  
Surface mount - add SM after part no.  
Tape&reel - add SMT&R after part no.
- Low input current  $\pm 1\text{mA } I_F$
- High Current Transfer Ratios
- High Isolation Voltage ( $5.3\text{kV}_{\text{RMS}}, 7.5\text{kV}_{\text{PK}}$ )
- High  $BV_{\text{CEO}}$  (70V min)
- AC or polarity insensitive input
- All electrical parameters 100% tested
- Custom electrical selections available

**APPLICATIONS**

- Computer terminals
- Industrial systems controllers
- Measuring instruments
- Telephone sets, Telephone exchanges
- Signal transmission between systems of different potentials and impedances

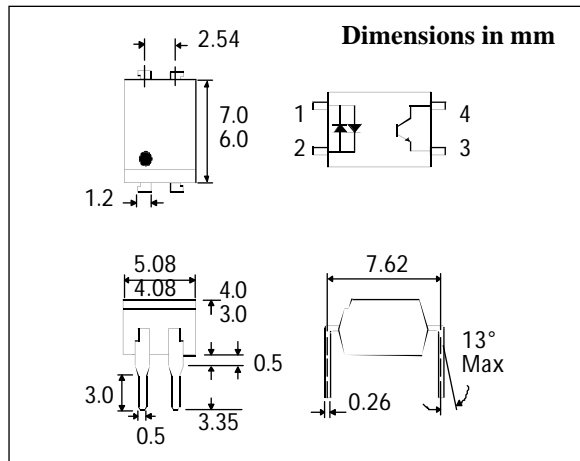

**ABSOLUTE MAXIMUM RATINGS  
(25°C unless otherwise specified)**

Storage Temperature \_\_\_\_\_  $-55^\circ\text{C}$  to  $+125^\circ\text{C}$   
Operating Temperature \_\_\_\_\_  $-55^\circ\text{C}$  to  $+100^\circ\text{C}$   
Lead Soldering Temperature  
(1/16 inch (1.6mm) from case for 10 secs)  $260^\circ\text{C}$

**INPUT DIODE**

Forward Current \_\_\_\_\_  $\pm 50\text{mA}$   
Power Dissipation \_\_\_\_\_  $70\text{mW}$

**OUTPUT TRANSISTOR**

Collector-emitter Voltage  $BV_{\text{CEO}}$  \_\_\_\_\_  $70\text{V}$   
Emitter-collector Voltage  $BV_{\text{ECO}}$  \_\_\_\_\_  $6\text{V}$   
Power Dissipation \_\_\_\_\_  $150\text{mW}$

**POWER DISSIPATION**

Total Power Dissipation \_\_\_\_\_  $200\text{mW}$   
(derate linearly  $2.67\text{mW}/^\circ\text{C}$  above  $25^\circ\text{C}$ )

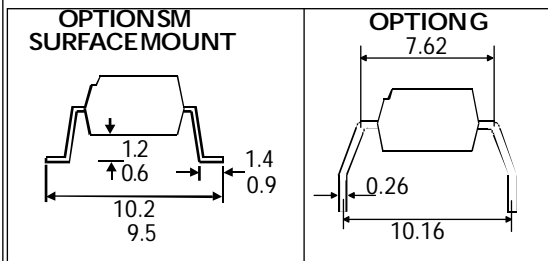

**ISOCOM COMPONENTS LTD**  
Unit 25B, Park View Road West,  
Park View Industrial Estate, Brenda Road  
Hartlepool, Cleveland, TS25 1YD  
Tel: (01429) 863609 Fax :(01429) 863581

**ISOCOM INC**  
720 E., Park Boulevard, Suite 104,  
Plano, TX 75074 USA  
Tel: (972) 423-5521  
Fax: (972) 422-4549

**ELECTRICAL CHARACTERISTICS (  $T_A = 25^\circ\text{C}$  Unless otherwise noted )**

PARAMETER		MIN	TYP	MAX	UNITS	TEST CONDITION
Input	Forward Voltage ( $V_F$ )			1.65	V	$I_F = \pm 50\text{mA}$
Output	Collector-emitter Breakdown ( $BV_{CEO}$ ) ( Note 2 )	70			V	$I_C = 1\text{mA}$
	Emitter-collector Breakdown ( $BV_{ECO}$ )	6			V	$I_E = 100\mu\text{A}$
	Collector-emitter Dark Current ( $I_{CEO}$ ) SFH620-1,2 SFH620-3			50 100	nA nA	$V_{CE} = 10\text{V}$
Coupled	Current Transfer Ratio (CTR) (Note 2) SFH620-1 SFH620-2 SFH620-3	40		125	%	$\pm 10\text{mA } I_F, 5\text{V } V_{CE}$
		63		200	%	
		100		320	%	
	SFH620-1 SFH620-2 SFH620-3	13			%	$\pm 1\text{mA } I_F, 5\text{V } V_{CE}$
		22			%	
		34			%	
	Collector-emitter Saturation Voltage $V_{CESAT}$			0.4	V	$\pm 10\text{mA } I_F, 2.5\text{mA } I_C$
Input to Output Isolation Voltage $V_{ISO}$	5300 7500			$V_{RMS}$ $V_{PK}$	See note 1 See note 1	
Input-output Isolation Resistance $R_{ISO}$	$5 \times 10^{10}$			$\Omega$	$V_{IO} = 500\text{V}$ (note 1)	

- Note 1 Measured with input leads shorted together and output leads shorted together.  
 Note 2 Special Selections are available on request. Please consult the factory.

**SWITCHING CHARACTERISTICS**

1. Linear Operation (without saturation) Fig 1.  
 $I_F = 10\text{mA}$ ,  $V_{CC} = 5\text{V}$ ,  $R_L = 75\Omega$ ,  $T_A = 25^\circ\text{C}$

			UNITS
Turn-on Time	$t_{on}$	3.0	$\mu\text{s}$
Rise Time	$t_r$	2.0	$\mu\text{s}$
Turn-off Time	$t_{off}$	2.3	$\mu\text{s}$
Fall Time	$t_f$	2.0	$\mu\text{s}$
Cut-off Frequency	$F_{CO}$	250	kHz

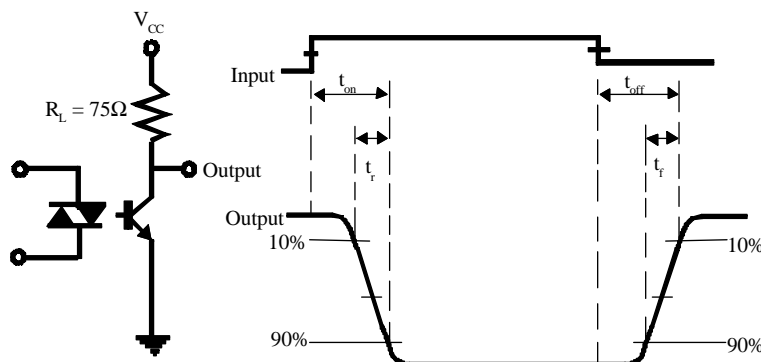
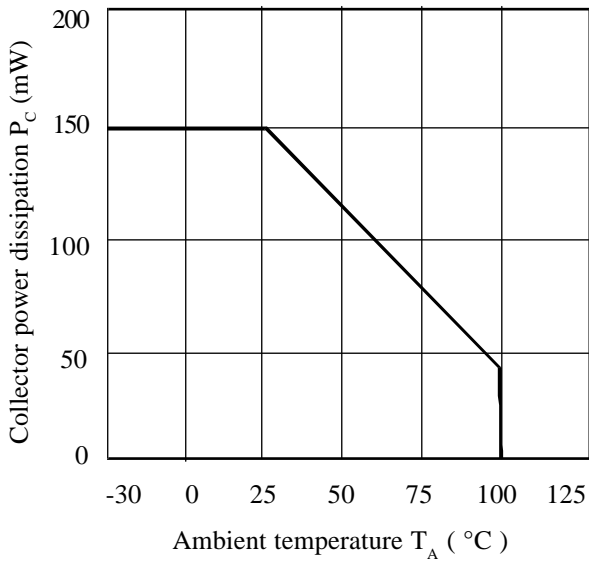
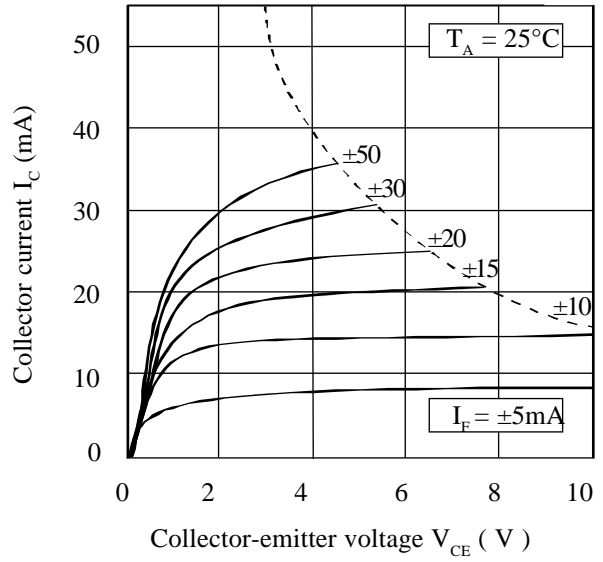

FIG 1

**Collector Power Dissipation vs. Ambient Temperature**



**Collector Current vs. Collector-emitter Voltage (normalized to SFH620-2 & SFH620-3)**



**Forward Current vs. Ambient Temperature**

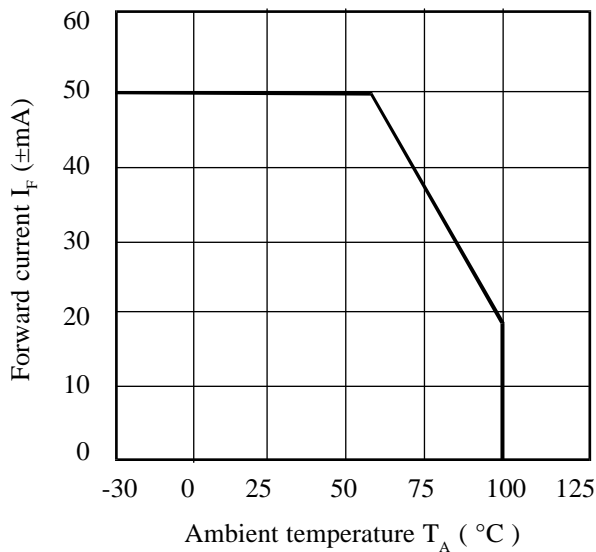

**Current Transfer Ratio vs. Forward Current**

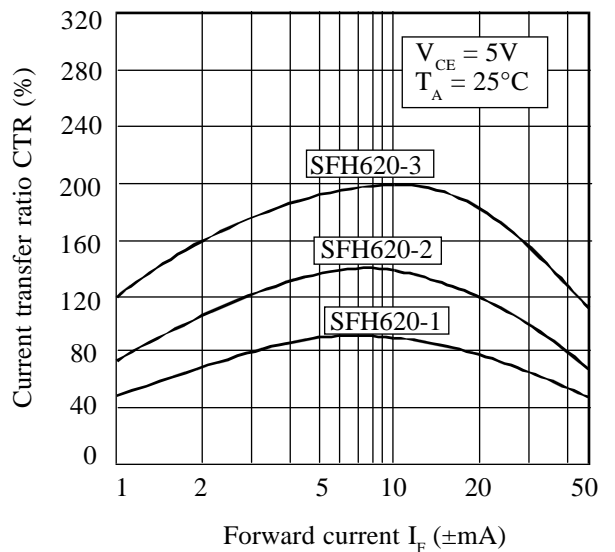

**Relative Current Transfer Ratio vs. Ambient Temperature**

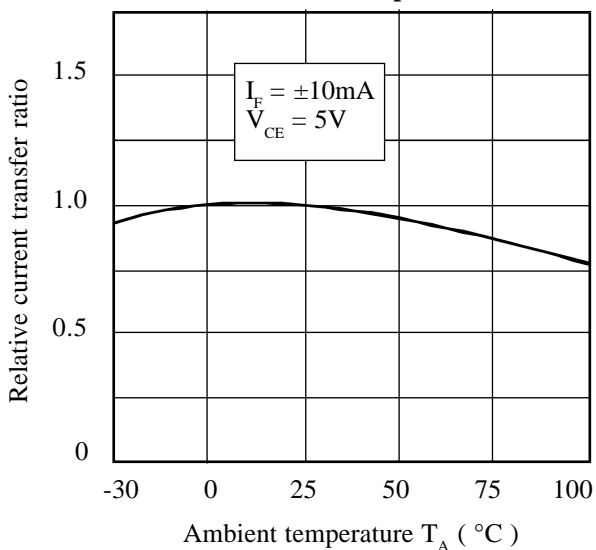

**Collector-emitter Saturation Voltage vs. Ambient Temperature**

