

IL205A, IL206A, IL207A, IL208A,
IL211A, IL212A, IL213A,



**SMALL OUTLINE OPTICALLY
COUPLED ISOLATOR
TRANSISTOR OUTPUT**

DESCRIPTION

This series of optically coupled isolators consist of a Gallium Arsenide infrared emitting diode and NPN silicon photo transistor mounted in a standard 8 pin SOIC package, which makes them ideally suited for high density applications with limited space.

FEATURES

- Standard SOIC-8 Footprint with 0.05" Lead Spacing
- Specified min. and max. CTR at 10mA I_F, 5V V_{CE}
IL205A, 40 - 80%
IL206A, 63 - 125%
IL207A, 100 - 200%
IL208A, 160 - 320%
- Specified minimum CTR at 10mA I_F, 5V V_{CE}
IL211A, 20%
IL212A, 50%
IL213A, 100%
- Specified minimum CTR at 1mA I_F, 5V V_{CE}
IL215A, 20%
IL216A, 50%
IL217A, 100%
- Isolation Voltage, 2500 V_{RMS}
- High BV_{CEO} (70V min)
- All electrical parameters 100% tested
- Available in Tape and Reel - add suffix " T & R "
- Custom Electrical Selections available

**ABSOLUTE MAXIMUM RATINGS
(25°C unless otherwise noted)**

Storage Temperature _____ -55°C to +125°C
Operating Temperature _____ -55°C to +100°C
Lead Soldering Temperature _____ 260°C
(single wave for 10 secs)
Input to Output Isolation Voltage _____ 2500V_{RMS}

INPUT DIODE

Forward D.C. Current _____ 60mA
Reverse D.C. Voltage _____ 6V
Peak Forward Current (tp ≤ 10µs) _____ 3A
Power Dissipation _____ 100mW
(derate linearly 1.33mW/°C above 25°C)
Junction Temperature _____ 125°C

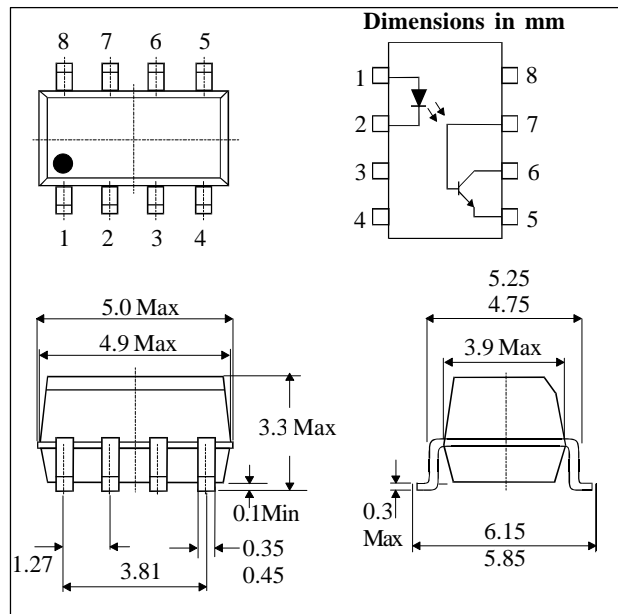

APPLICATIONS

- Computer Terminals
- Industrial Systems Controllers
- Hybrid substrates that require high density mounting
- Signal Transmission between systems of different potentials and impedances

OUTPUT TRANSISTOR

Collector-Emitter Voltage BV_{CEO} _____ 70V
Emitter-Collector Voltage BV_{ECO} _____ 7V
Collector-Base Voltage BV_{CBO} _____ 70V
Collector Current _____ 50mA
Collector Current _____ 100mA
(pw ≤ 10ms , 50% duty ratio)
Power Dissipation _____ 150mW
(derate linearly 2.00mW/°C above 25°C)
Junction Temperature _____ 125°C

PACKAGE

Total Power Dissipation _____ 250mW
(derate linearly 3.3mW/°C above 25°C)

ISOCOM COMPONENTS LTD

Unit 25B, Park View Road West,
Park View Industrial Estate, Brenda Road
Hartlepool, Cleveland, TS25 1YD
Tel: (01429) 863609 Fax: (01429) 863581

ISOCOM INC

1024 S. Greenville Ave, Suite 240,
Allen, TX 75002 USA
Tel: (214) 495-0755 Fax: (214) 495-0901
e-mail info@isocom.com
http://www.isocom.com

ELECTRICAL CHARACTERISTICS (25°C unless otherwise noted)

PARAMETER		MIN	TYP	MAX	UNITS	TEST CONDITIONS
Input	Forward Voltage (V_F) Capacitance Reverse Current (I_R)		1.2 50	1.5 100	Volt pF μ A	$I_F = 10 \text{ mA}$ $V_R = 0, f = 1 \text{ MHz}$ $V_R = 6 \text{ V}$
Output	Collector-Emitter Voltage (BV_{CEO}) Emitter-Collector Voltage (BV_{ECO}) Collector-Base Voltage (BV_{CBO}) Collector-Emitter Dark Current (I_{CEO})	70 7 70			Volt Volt Volt nA	$I_C = 100 \mu\text{A}$ $I_E = 100 \mu\text{A}$ $I_C = 100 \mu\text{A}$ $V_{CE} = 10 \text{ V}$
Coupled	Current Transfer Ratio (CTR) IL205A	40		80	%	$I_F = 10 \text{ mA}, V_{CE} = 5 \text{ V}$
	IL206A	63		125	%	
	IL207A	100		200	%	
	IL208A	160		320	%	
	IL211A	20			%	
	IL212A	50			%	
	IL213A	100			%	
	IL205A	13			%	$I_F = 1 \text{ mA}, V_{CE} = 5 \text{ V}$
	IL206A	22			%	
	IL207A	34			%	
	IL208A	56			%	
	IL215A	20			%	
	IL216A	50			%	
	IL217A	100			%	
	Collector-Emitter Saturation Voltage $V_{CE(SAT)}$ (IL205A to IL213A)			0.4	Volt	$I_F = 10 \text{ mA}, I_C = 2 \text{ mA}$
	Collector-Emitter Saturation Voltage $V_{CE(SAT)}$ (IL215A to IL217A)			0.4	Volt	$I_F = 1 \text{ mA}, I_C = 0.1 \text{ mA}$
	Capacitance Input to Output (C_{IO})		0.3		pF	$f = 1 \text{ MHz}$ (note 1)
	Input to Output Isolation Resistance (R_{IO})	10^{11}			Ω	$V_{IO} = 500 \text{ V}$ (note 1)
	Input to Output Isolation Voltage (V_{IO})	2500			V_{RMS}	Note 1
	Output Turn on Time (t_{on})		3.0		μ s	$I_C = 2 \text{ mA},$ $V_{CC} = 10 \text{ V}, R_L = 100 \Omega$
	Output Turn off Time (t_{off})		3.0		μ s	
	Output Rise Time (t_r)		1.6		μ s	
	Output Fall Time (t_f)		2.2		μ s	

Note 1. Measured with input leads shorted together and output leads shorted together.

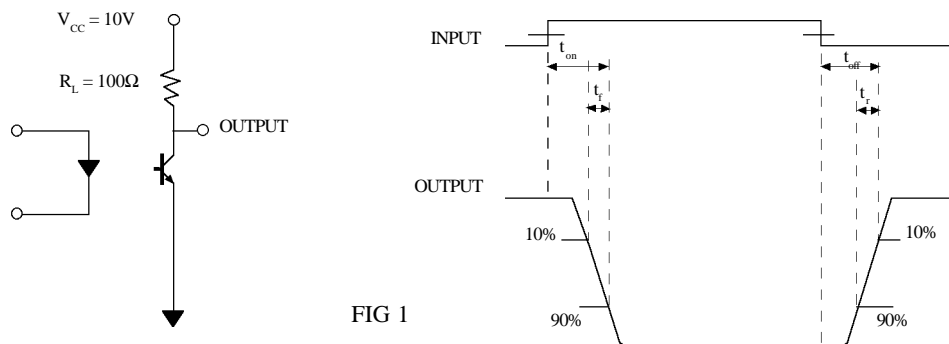

Collector Power Dissipation vs. Ambient Temperature

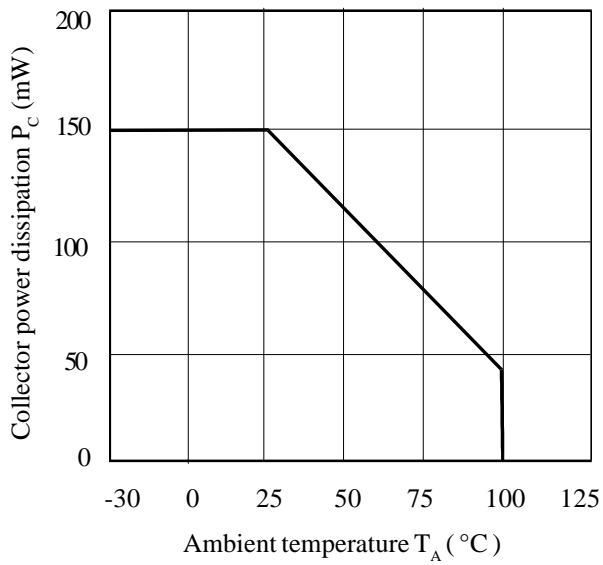

Current Transfer Ratio vs. Forward Current

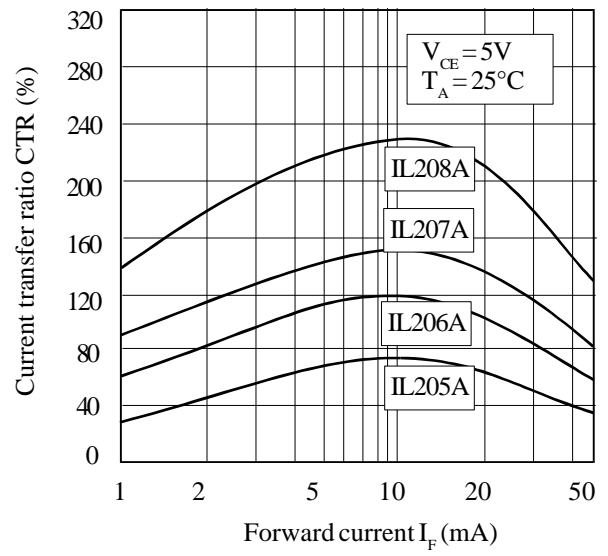

Forward Current vs. Ambient Temperature

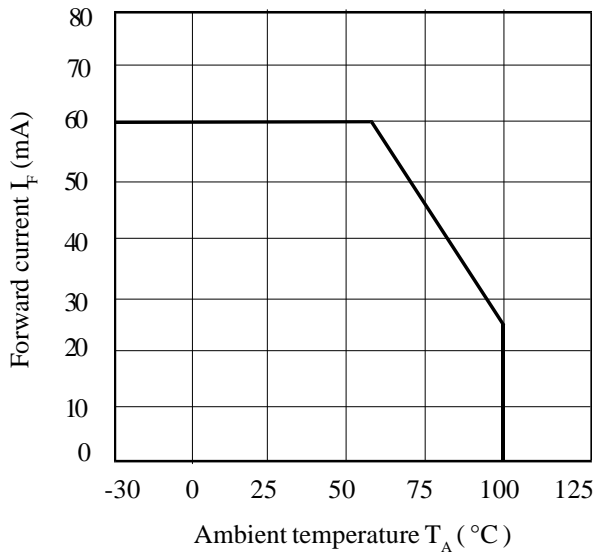

Current Transfer Ratio vs. Forward Current

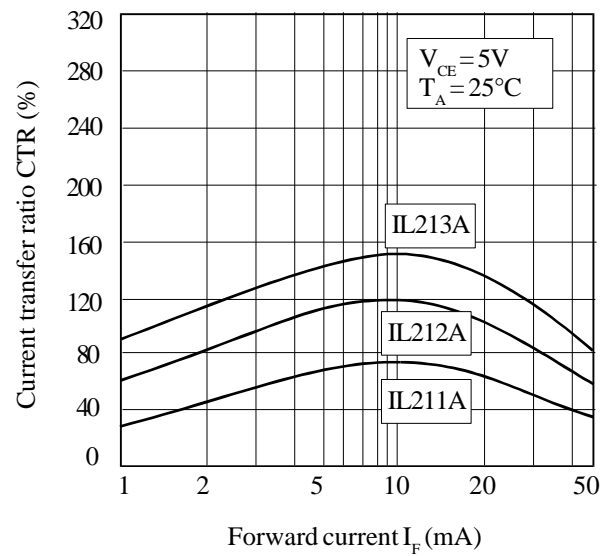

Relative Current Transfer Ratio vs. Ambient Temperature

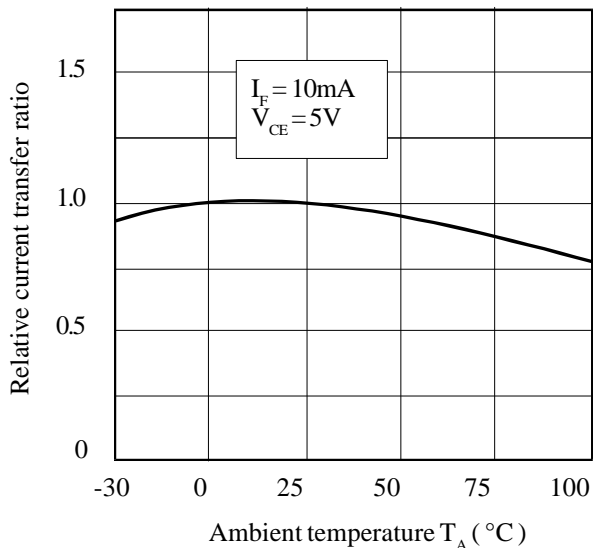

Current Transfer Ratio vs. Forward Current

