

# High Voltage IGBT

**IXSH 45N120B**  
**IXST 45N120B**

"S" Series - Improved SCSOA Capability

$$I_{C25} = 75 \text{ A}$$

$$V_{CES} = 1200 \text{ V}$$

$$V_{CE(sat)} = 3.0 \text{ V}$$

Preliminary data

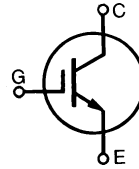

Symbol	Test Conditions	Maximum Ratings	
$V_{CES}$	$T_J = 25^\circ\text{C}$ to $150^\circ\text{C}$	1200	V
$V_{CGR}$	$T_J = 25^\circ\text{C}$ to $150^\circ\text{C}$ ; $R_{GE} = 1 \text{ M}\Omega$	1200	V
$V_{GES}$	Continuous	$\pm 20$	V
$V_{GEM}$	Transient	$\pm 30$	V
$I_{C25}$	$T_C = 25^\circ\text{C}$ (limited by leads)	75	A
$I_{C90}$	$T_C = 90^\circ\text{C}$	45	A
$I_{CM}$	$T_C = 25^\circ\text{C}$ , 1 ms	180	A
<b>SSOA (RBSOA)</b>	$V_{GE} = 15 \text{ V}$ , $T_J = 125^\circ\text{C}$ , $R_G = 5 \Omega$ Clamped inductive load	$I_{CM} = 90$ @ $0.8 V_{CES}$	A
$t_{SC}$	$T_J = 125^\circ\text{C}$ , $V_{GE} = 720 \text{ V}$ ; $V_{GE} = 15 \text{ V}$ , $R_G = 5 \Omega$	10	$\mu\text{s}$
$P_C$	$T_C = 25^\circ\text{C}$	300	W
$T_J$		-55 ... +150	$^\circ\text{C}$
$T_{JM}$		150	$^\circ\text{C}$
$T_{stg}$		-55 ... +150	$^\circ\text{C}$
$M_d$	Mounting torque (TO-247)	1.13/10	Nm/lb.in.
Maximum lead temperature for soldering 1.6 mm (0.062 in.) from case for 10 s		300	$^\circ\text{C}$
<b>Weight</b>	TO-247	6	g

TO-247 AD (IXSH)

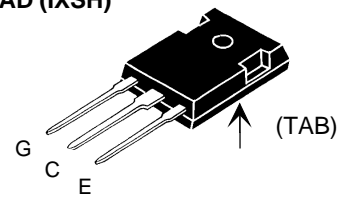

TO-268 (IXST)

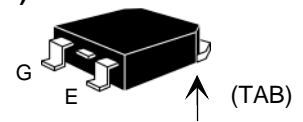

G = Gate  
S = Emitter

C = Collector  
TAB = Collector

## Features

- Epitaxial Silicon drift region
  - fast switching
  - small tail current
- MOS gate turn-on for drive simplicity

## Applications

- AC motor speed control
- DC servo and robot drives
- Uninterruptible power supplies (UPS)
- Switched-mode and resonant-mode power supplies
- Welding

Symbol	Test Conditions	Characteristic Values ( $T_J = 25^\circ\text{C}$ , unless otherwise specified)		
		min.	typ.	max.
$BV_{CES}$	$I_C = 1.0 \text{ mA}$ , $V_{GE} = 0 \text{ V}$	1200		V
$V_{GE(th)}$	$I_C = 250 \mu\text{A}$ , $V_{CE} = V_{GE}$	3		6 V
$I_{CES}$	$V_{CE} = 0.8 \cdot V_{CES}$ Note 1 $T_J = 125^\circ\text{C}$			50 $\mu\text{A}$ 2.5 mA
$I_{GES}$	$V_{CE} = 0 \text{ V}$ , $V_{GE} = \pm 20 \text{ V}$			$\pm 100 \text{ nA}$
$V_{CE(sat)}$	$I_C = I_{C90}$ , $V_{GE} = 15 \text{ V}$ Note 2 $T_J = 125^\circ\text{C}$	2.5	3.0	V
		2.6		V

Symbol	Test Conditions	Characteristic Values ( $T_J = 25^\circ\text{C}$ , unless otherwise specified)		
		min.	typ.	max.
$g_{fs}$	$I_C = I_{C90}$ ; $V_{CE} = 10\text{ V}$ , Note 2	16	23	S
$C_{ies}$	$V_{CE} = 25\text{ V}$ , $V_{GE} = 0\text{ V}$ , $f = 1\text{ MHz}$		3300	pF
$C_{oes}$			240	pF
$C_{res}$			65	pF
$Q_g$	$I_C = I_{C90}$ , $V_{GE} = 15\text{ V}$ , $V_{CE} = 0.5 V_{CES}$		120	nC
$Q_{ge}$			40	nC
$Q_{gc}$			45	nC
$t_{d(on)}$	<b>Inductive load, <math>T_J = 25^\circ\text{C}</math></b>		36	ns
$t_{ri}$	$I_C = I_{C90}$ , $V_{GE} = 15\text{ V}$		27	ns
$t_{d(off)}$	$R_G = 5\ \Omega$		360	500 ns
$t_{fi}$	$V_{CE} = 0.8 V_{CES}$ Note 3		380	750 ns
$E_{off}$			13	22 mJ
$t_{d(on)}$	<b>Inductive load, <math>T_J = 125^\circ\text{C}</math></b>		38	ns
$t_{ri}$	$I_C = I_{C90}$ , $V_{GE} = 15\text{ V}$		29	ns
$E_{on}$	$R_G = 5\ \Omega$ , $V_{CE} = 0.8 V_{CES}$ Note 3		2.9	mJ
$t_{d(off)}$			440	ns
$t_{fi}$			700	ns
$E_{off}$			22	mJ
$R_{thJC}$				0.42 K/W
$R_{thCK}$	(TO-247)		0.25	K/W

- Notes: 1. Device must be heatsunk for high temperature leakage current measurements to avoid thermal runaway.  
 2. Pulse test,  $t \leq 300\ \mu\text{s}$ , duty cycle  $\leq 2\%$   
 3. Switching times may increase for  $V_{CE}$  (Clamp)  $> 0.8 \cdot V_{CES}$ , higher  $T_J$  or increased  $R_G$ .

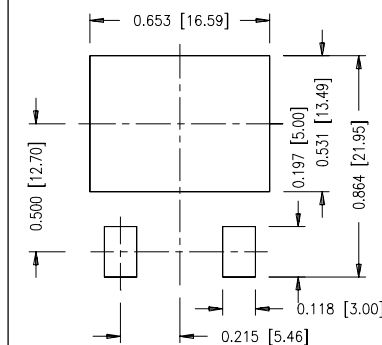
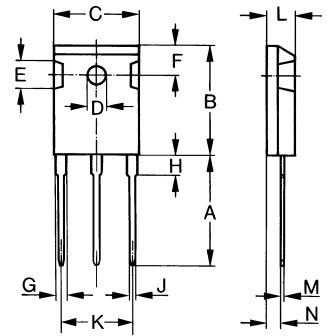
**Min. Recommended Footprint**

**TO-247 AD (IXSH) Outline**

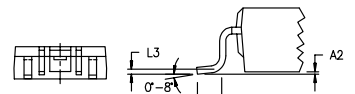
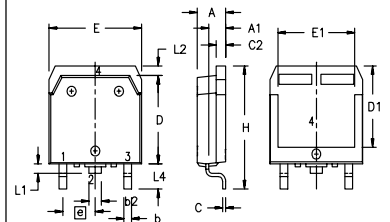
Dim.	Millimeter		Inches	
	Min.	Max.	Min.	Max.
A	19.81	20.32	0.780	0.800
B	20.80	21.46	0.819	0.845
C	15.75	16.26	0.610	0.640
D	3.55	3.65	0.140	0.144
E	4.32	5.49	0.170	0.216
F	5.4	6.2	0.212	0.244
G	1.65	2.13	0.065	0.084
H	-	4.5	-	0.177
J	1.0	1.4	0.040	0.055
K	10.8	11.0	0.426	0.433
L	4.7	5.3	0.185	0.209
M	0.4	0.8	0.016	0.031
N	1.5	2.49	0.087	0.102

**TO-268AA (D<sup>3</sup> PAK)**

Dim.	Millimeter		Inches	
	Min.	Max.	Min.	Max.
A	4.9	5.1	.193	.201
A <sub>1</sub>	2.7	2.9	.106	.114
A <sub>2</sub>	.02	.25	.001	.010
b	1.15	1.45	.045	.057
b <sub>2</sub>	1.9	2.1	.75	.83
C	.4	.65	.016	.026
D	13.80	14.00	.543	.551
E	15.85	16.05	.624	.632
E <sub>1</sub>	13.3	13.6	.524	.535
e	5.45 BSC		.215 BSC	
H	18.70	19.10	.736	.752
L	2.40	2.70	.094	.106
L <sub>1</sub>	1.20	1.40	.047	.055
L <sub>2</sub>	1.00	1.15	.039	.045
L <sub>3</sub>	0.25 BSC		.010 BSC	
L <sub>4</sub>	3.80	4.10	.150	.161