

## Features

- Built using the advantages and compatibility of CMOS and IXYS HDMOS™ processes
- Latch-Up Protected Over Entire Operating Range
- High Peak Output Current: 14A Peak
- Wide Operating Range: 4.5V to 25V
- High Capacitive Load Drive Capability: 15nF in <30ns
- Matched Rise And Fall Times
- Low Propagation Delay Time
- Low Output Impedance
- Low Supply Current

## Applications

- Driving MOSFETs and IGBTs
- Motor Controls
- Line Drivers
- Pulse Generators
- Local Power ON/OFF Switch
- Switch Mode Power Supplies (SMPS)
- DC to DC Converters
- Pulse Transformer Driver
- Class D Switching Amplifiers

## General Description

The IXDI414/IXDN414 is a high speed high current gate driver specifically designed to drive the largest MOSFETs and IGBTs to their minimum switching time and maximum practical frequency limits. The IXDI/N414 can source and sink 14A of peak current while producing voltage rise and fall times of less than 30ns to drive the latest IXYS MOSFETs & IGBTs. The input of the driver is compatible with TTL or CMOS and is fully immune to latch up over the entire operating range. Designed with small internal delays, a patent-pending circuit virtually eliminates transistor cross conduction and current shoot-through. Improved speed and drive capabilities are further enhanced by very low, matched rise and fall times.

The IXDN414 is configured as a non-inverting gate driver and the IXDI414 is an inverting gate driver.

The IXDN414/IXDI414 family are available in standard 8 pin P-DIP (PI), 5-pin TO-220 (CI, CM) and TO-263 (YI, YM) surface-mount packages.

Figure 1 - IXDN414 14A Non-Inverting Gate Driver Functional Block Diagram

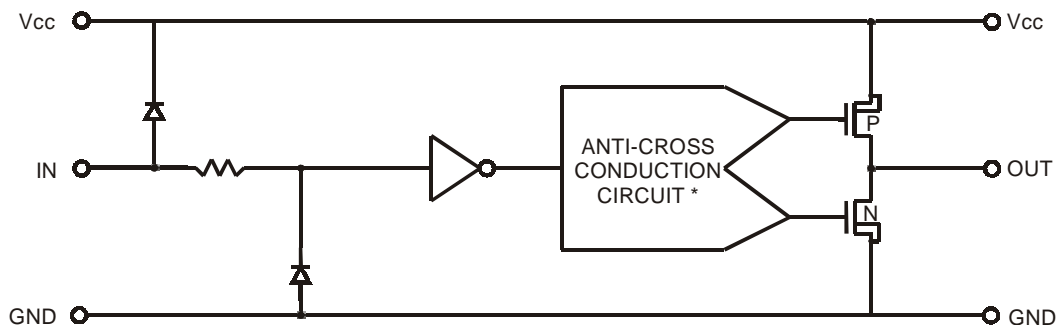

\* Patent Pending

Figure 2 - IXDI414 Inverting 14A Gate Driver Functional Block Diagram

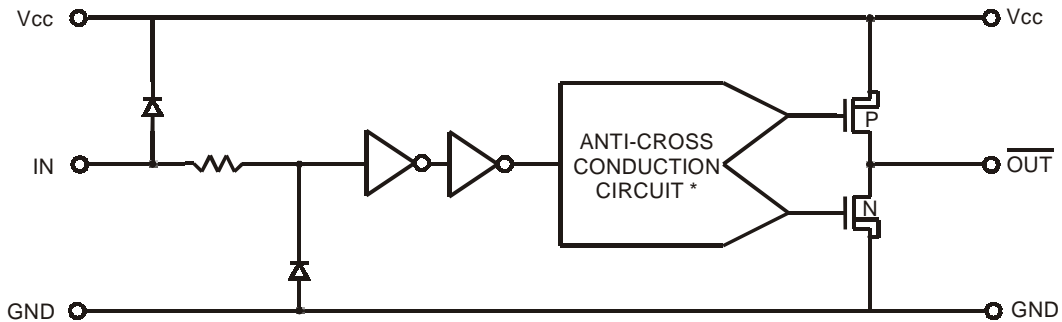

### Pin Description And Configuration

SYMBOL	FUNCTION	DESCRIPTION
VCC	Supply Voltage	Positive power-supply voltage input. This pin provides power to the entire chip. The range for this voltage is from 4.5V to 25V.
IN	Input	Input signal-TTL or CMOS compatible.
OUT	Output	Driver Output. For application purposes, this pin is connected via an external resistor to a Gate of a MOSFET/IGBT.
GND	Ground	The system ground pin. Internally connected to all circuitry, this pin provides ground reference for the entire chip. This pin should be connected to a low noise analog ground plane for optimum performance.

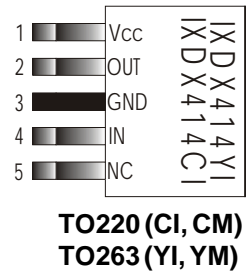
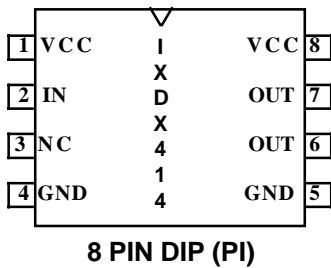

ORDERING INFORMATION			
Part Number	Package Type	Temp. Range	Configuration
IXDN414PI	8-Pin PDIP	-40°C to +85°C	Non Inverting
IXDN414CI	5-Pin TO-220		
IXDN414CM	5-Pin TO-220	-55°C to +125°C	
IXDN414YI	5-Pin TO-263	-40°C to +85°C	
IXDN414YM	5-Pin TO-263	-55°C to +125°C	
IXDI414PI	8-Pin PDIP	-40°C to +85°C	Inverting
IXDI414CI	5-Pin TO-220		
IXDI414CM	5-Pin TO-220	-55°C to +125°C	
IXDI414YI	5-Pin TO-263	-40°C to +85°C	
IXDI414YM	5-Pin TO-263	-55°C to +125°C	

**NOTE:** Mounting or solder tabs on all packages are connected to ground

\* Patent Pending

**Absolute Maximum Ratings (Note 1)**

Parameter	Value
Supply Voltage	25V
All Other Pins	-0.3V to $V_{CC} + 0.3V$
Power Dissipation	
$T_{CASE} \leq 85^{\circ}C$ : TO220 (CI), TO263 (YI)	16W
$T_{CASE} \leq 125^{\circ}C$ : TO220 (CM), TO263 (YM)	16W
Power Dissipation, $T_{AMBIENT} \leq 25^{\circ}C$	
8 Pin PDIP (PI)	975mW
TO220 (CI, CM), TO263 (YI, YM)	2W
Derating Factors (to Ambient)	
8 Pin PDIP (PI)	7.6mW/ $^{\circ}C$
TO220 (CI, CM), TO263 (YI, YM)	0.1W/ $^{\circ}C$
Storage Temperature	-65 $^{\circ}C$ to 150 $^{\circ}C$
Soldering Lead Temperature (10 seconds maximum)	300 $^{\circ}C$

**Operating Ratings**

Parameter	Value
Maximum Junction Temperature	150 $^{\circ}C$
Operating Temperature Range	-40 $^{\circ}C$ to 85 $^{\circ}C$
Thermal Impedance (Junction To Case)	
TO220 (CI, CM), TO263 (YI, YM) ( $\theta_{JC}$ )	0.55 $^{\circ}C/W$

**Electrical Characteristics**

Unless otherwise noted,  $T_A = 25^{\circ}C$ ,  $4.5V \leq V_{CC} \leq 25V$ .

All voltage measurements with respect to GND. Device configured as described in *Test Conditions*.

Symbol	Parameter	Test Conditions	Min	Typ	Max	Units
$V_{IH}$	High input voltage		3.5			V
$V_{IL}$	Low input voltage				0.8	V
$V_{IN}$	Input voltage range		-5		$V_{CC} + 0.3$	V
$I_{IN}$	Input current	$0V \leq V_{IN} \leq V_{CC}$	-10		10	$\mu A$
$V_{OH}$	High output voltage		$V_{CC} - 0.025$			V
$V_{OL}$	Low output voltage				0.025	V
$R_{OH}$	Output resistance @ Output high	$I_{OUT} = 10mA$ , $V_{CC} = 18V$		600	1000	$m\Omega$
$R_{OL}$	Output resistance @ Output Low	$I_{OUT} = 10mA$ , $V_{CC} = 18V$		600	1000	$m\Omega$
$I_{PEAK}$	Peak output current	$V_{CC}$ is 18V		14		A
$I_{DC}$	Continuous output current	8 Pin Dip (PI) (Limited by pkg power dissipation) TO220 (CI), TO263 (YI)			3 4	A A
$t_R$	Rise time <sup>(1)</sup>	$C_L = 15nF$ $V_{CC} = 18V$		22	27	ns
$t_F$	Fall time <sup>(1)</sup>	$C_L = 15nF$ $V_{CC} = 18V$		20	25	ns
$t_{ONDLY}$	On-time propagation delay <sup>(1)</sup>	$C_L = 15nF$ $V_{CC} = 18V$		30	33	ns
$t_{OFFDLY}$	Off-time propagation delay <sup>(1)</sup>	$C_L = 15nF$ $V_{CC} = 18V$		31	34	ns
$V_{CC}$	Power supply voltage		4.5	18	25	V
$I_{CC}$	Power supply current	$V_{IN} = 3.5V$ $V_{IN} = 0V$ $V_{IN} = + V_{CC}$		1 0	3 10 10	$mA$ $\mu A$ $\mu A$

<sup>(1)</sup> See Figures 3a and 3b

**Note 1:** Operating the device beyond parameters with listed "Absolute Maximum Ratings" may cause permanent damage to the device. Typical values indicate conditions for which the device is intended to be functional, but do not guarantee specific performance limits. The guaranteed specifications apply only for the test conditions listed. Exposure to absolute maximum rated conditions for extended periods may affect device reliability.

**CAUTION: These devices are sensitive to electrostatic discharge; follow proper ESD procedures when handling and assembling this component.**

Specifications subject to change without notice

Figure 3a - Characteristics Test Diagram

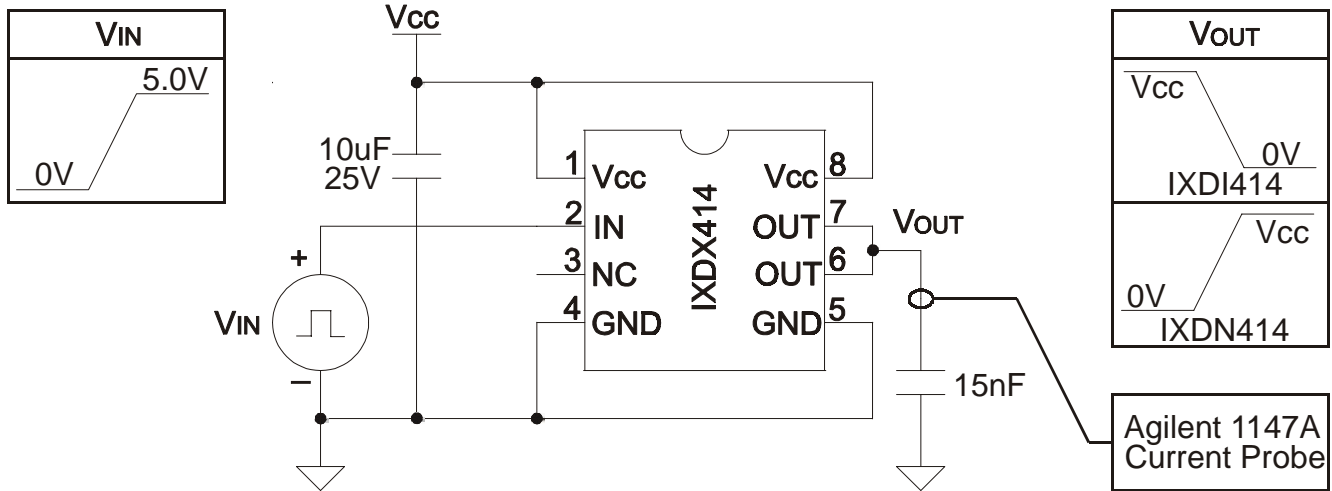
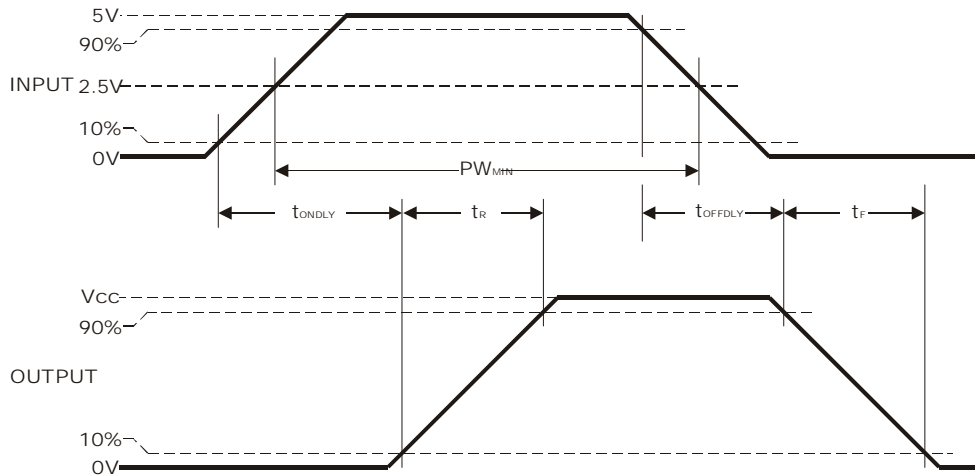
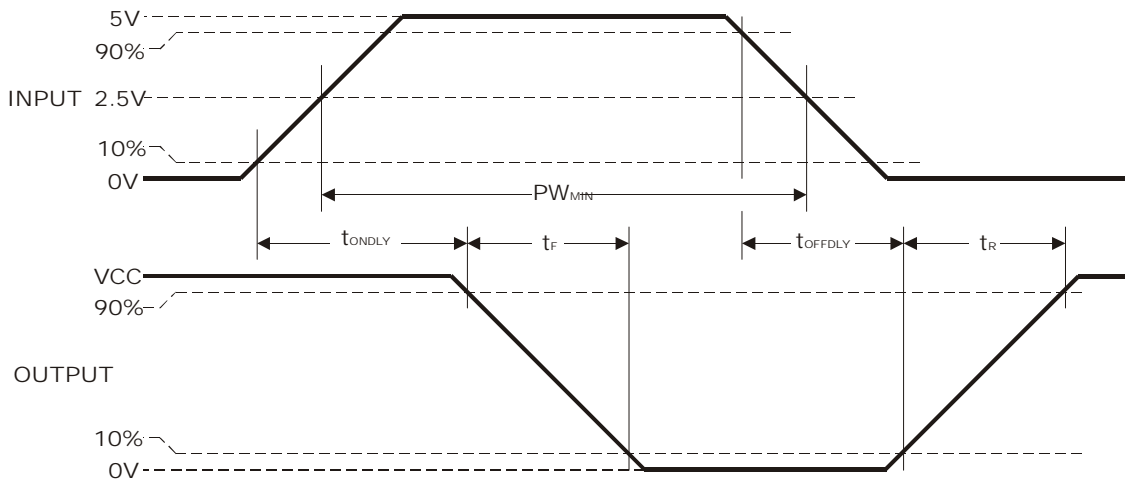

Figure 3b - Timing Diagrams

Non-Inverting (IXDN414) Timing Diagram



Inverting (IXDI414) Timing Diagram



Typical Performance Characteristics

Fig. 4 Rise Time vs. Supply Voltage

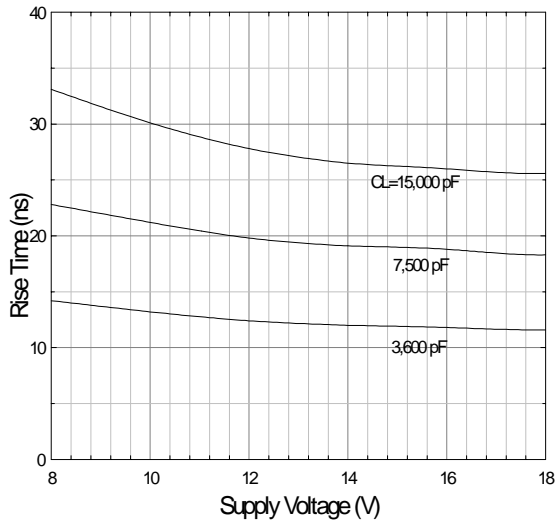

Fig. 5 Fall Time vs. Supply Voltage

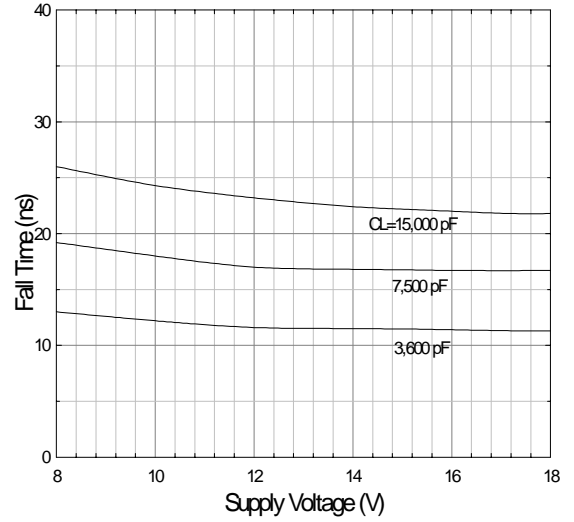

Fig. 6 Rise And Fall Times vs. Case Temperature  
 $C_L = 15 \text{ nF}, V_{CC} = 18\text{V}$

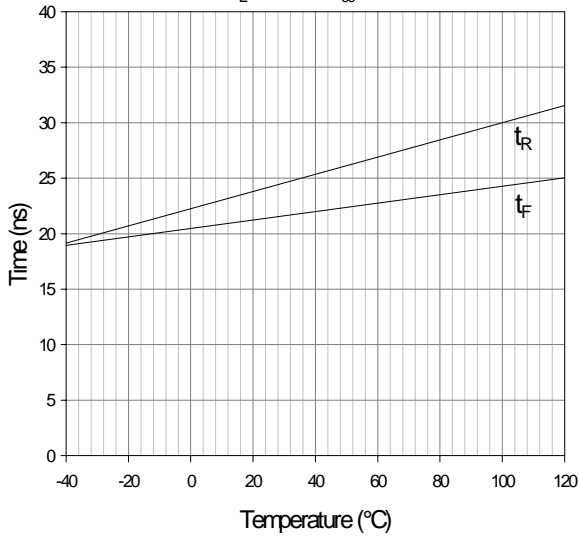

Fig. 7 Rise Time vs. Load Capacitance

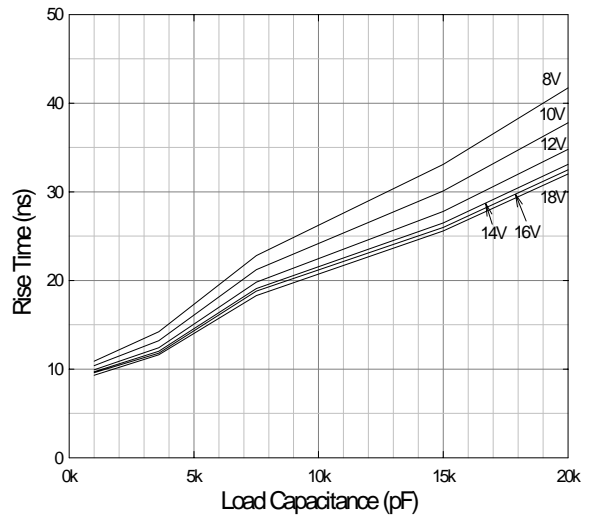

Fig. 8 Fall Time vs. Load Capacitance

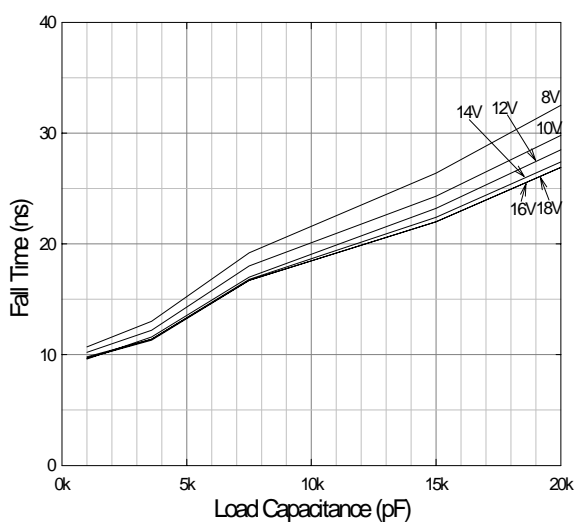

Fig. 9 Max / Min Input vs. Case Temperature  
 $V_{CC} = 18\text{V}, C_L = 15\text{nF}$

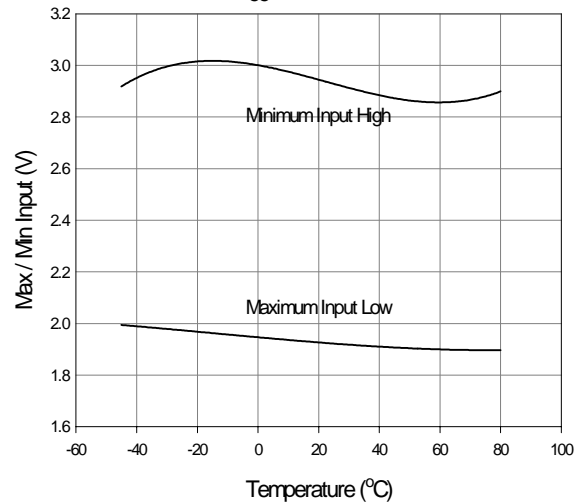

Fig. 11 Supply Current vs. Load Capacitance  
 $V_{cc}=18V$

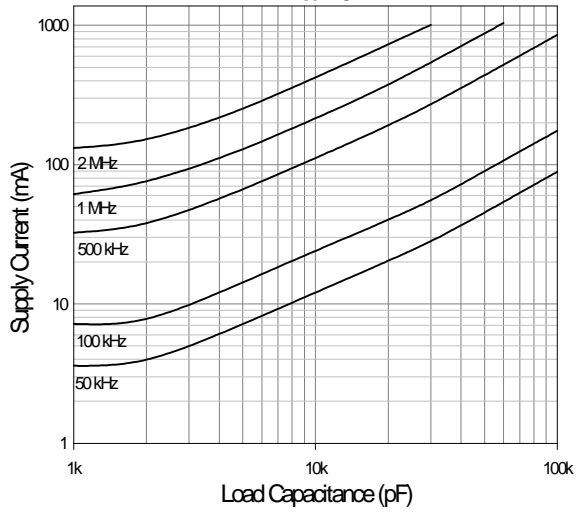

Fig. 12 Supply Current vs. Frequency  
 $V_{cc}=18V$

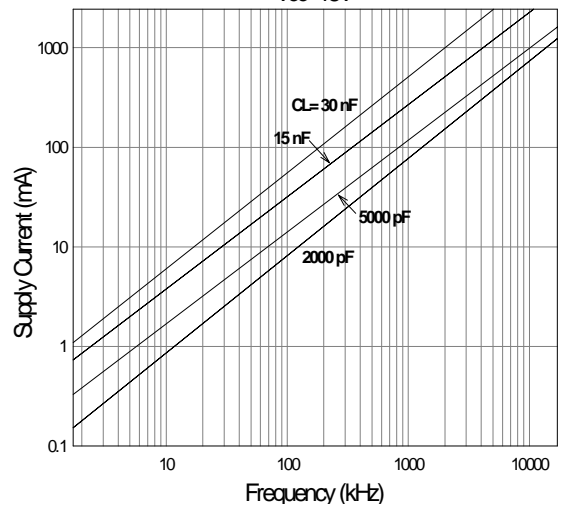

Fig. 13 Supply Current vs. Load Capacitance  
 $V_{cc}=12V$

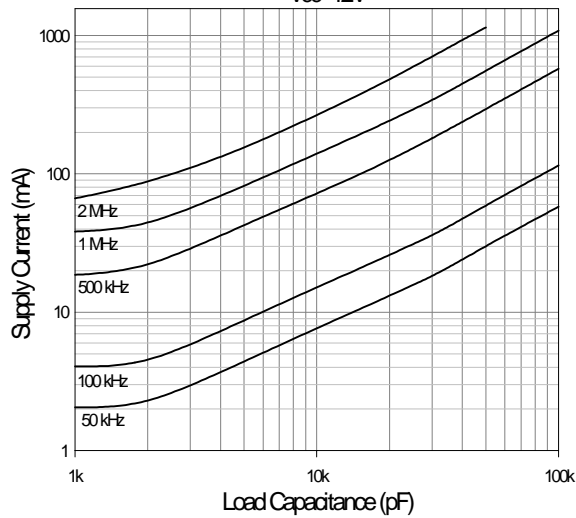

Fig. 14 Supply Current vs. Frequency  
 $V_{cc}=12V$

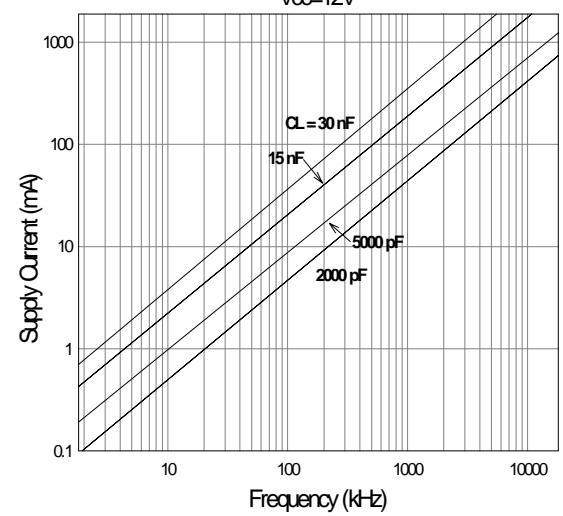

Fig. 15 Supply Current vs. Load Capacitance  
 $V_{cc}=8V$

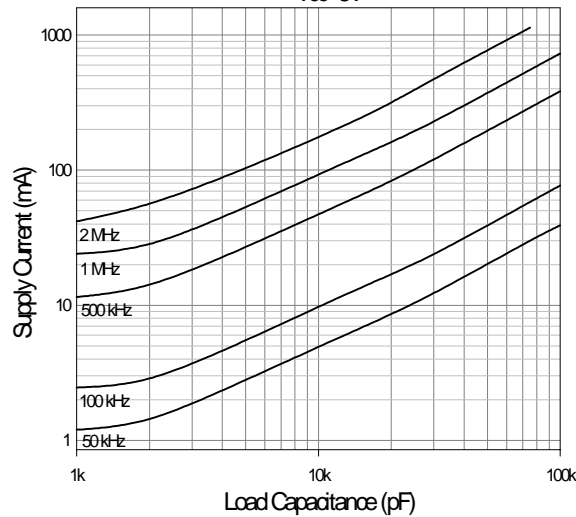

Fig. 16 Supply Current vs. Frequency  
 $V_{cc}=8V$

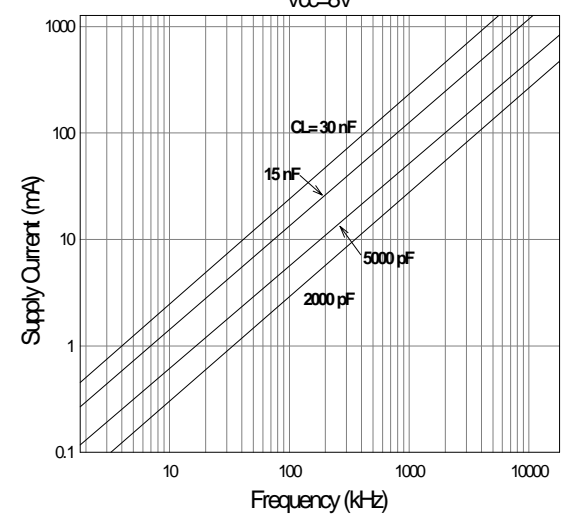

Fig. 17 Propagation Delay vs. Supply Voltage  
 $C_L = 15\text{nF}$   $V_{IN} = 5\text{V}@1\text{kHz}$

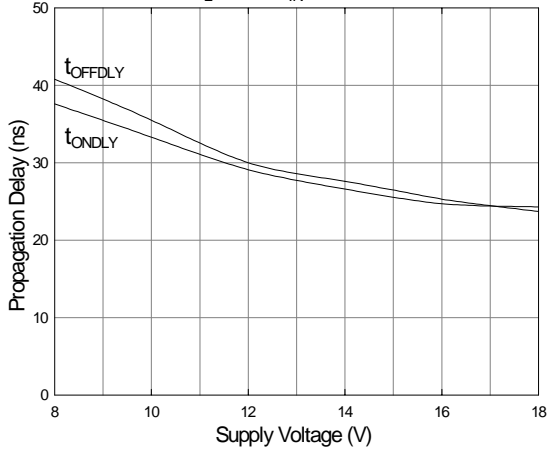

Fig. 18 Propagation Delay vs. Input Voltage  
 $C_L = 15\text{nF}$   $V_{CC} = 15\text{V}$

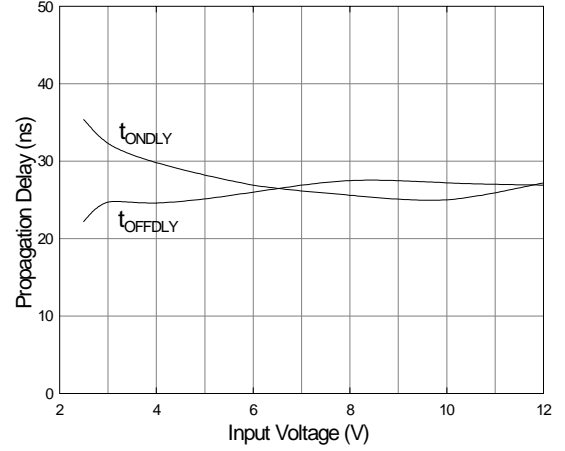

Fig. 19 Propagation Delay vs. Case Temperature  
 $C_L = 2500\text{pF}$ ,  $V_{CC} = 18\text{V}$

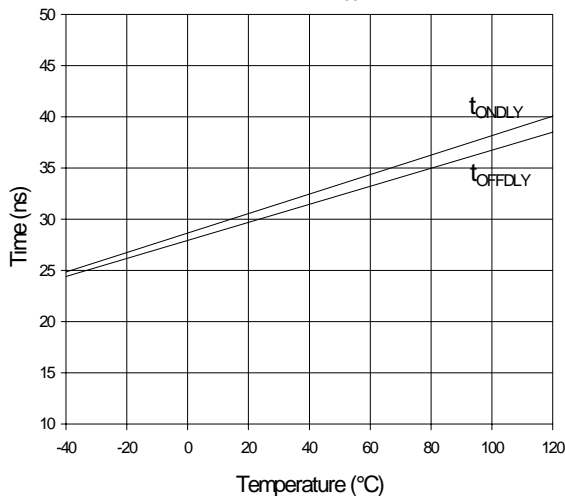

Fig. 20 Quiescent Supply Current vs. Case Temperature  
 $V_{CC} = 18\text{V}$   $V_{IN} = 5\text{V}@1\text{kHz}$

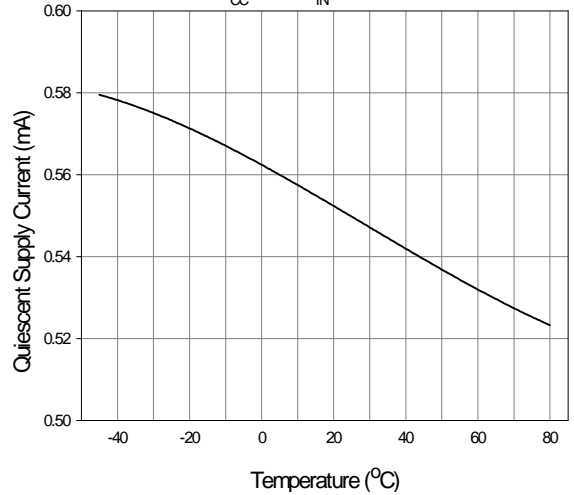

Fig. 21 P Channel Output Current vs. Case Temperature  
 $V_{CC} = 18\text{V}$   $C_L = 1\mu\text{F}$

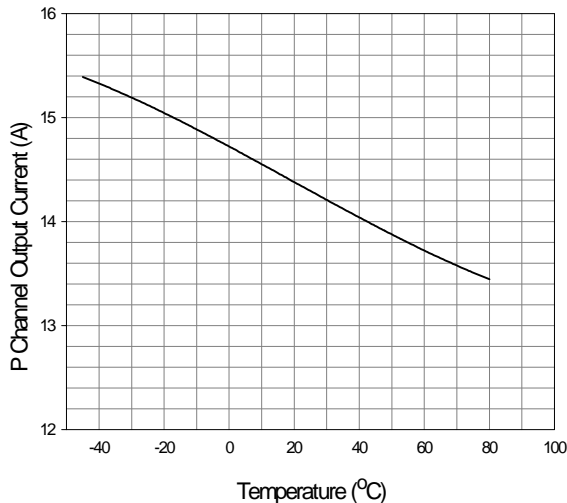

Fig. 22 N Channel Output Current vs. Case Temperature  
 $V_{CC} = 18\text{V}$   $C_L = 1\mu\text{F}$

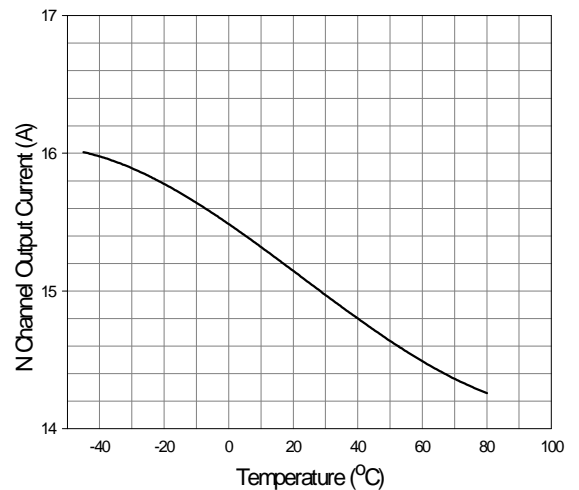

Fig. 23 Enable Threshold vs. Supply Voltage

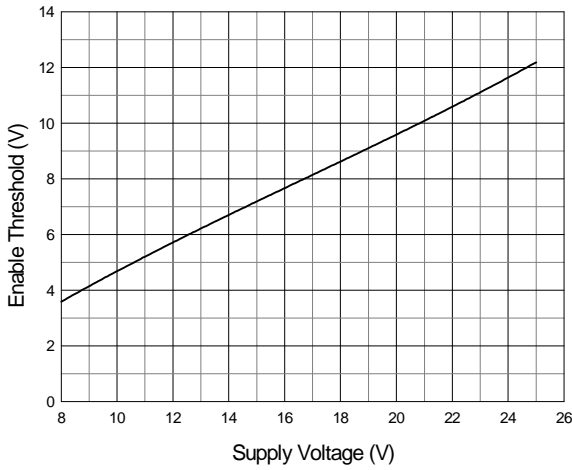

Fig. 24 High State Output Resistance vs. Supply Voltage

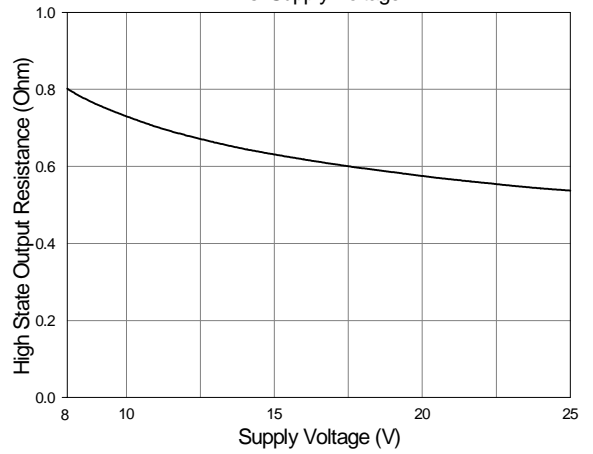

Fig. 25 Low-State Output Resistance vs. Supply Voltage

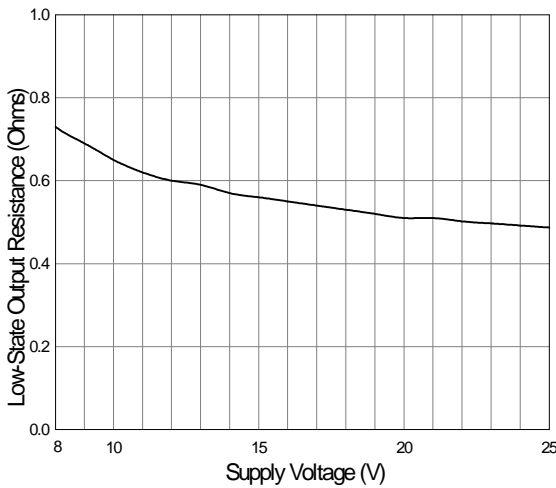

Fig. 26  $V_{CC}$  vs. P Channel Output Current  
 $C_L = 1\mu F$   $V_{IN} = 0-5V @ 1kHz$

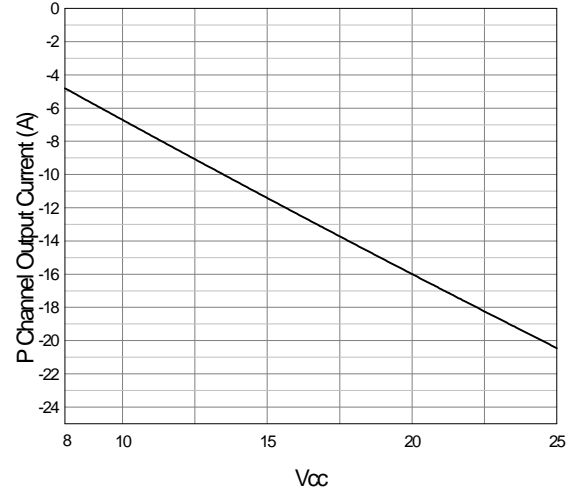
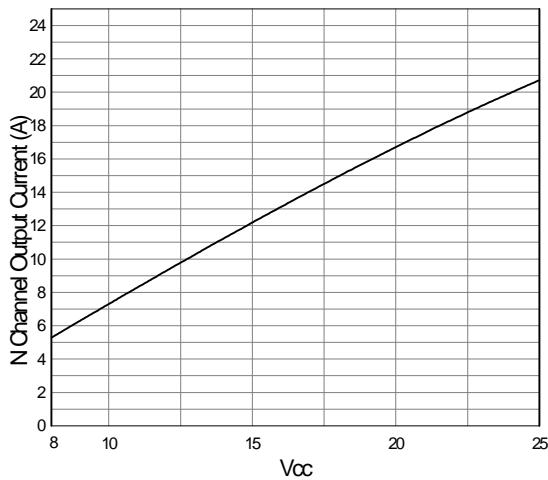

Fig. 27  $V_{CC}$  vs. N Channel Output Current  
 $C_L = 1\mu F$   $V_{IN} = 0-5V @ 1kHz$





## Supply Bypassing, Grounding Practices and Output Lead inductance

When designing a circuit to drive a high speed MOSFET utilizing the IXDN414/IXDI414, it is very important to observe certain design criteria in order to optimize performance of the driver. Particular attention needs to be paid to **Supply Bypassing, Grounding**, and minimizing the **Output Lead Inductance**.

Say, for example, we are using the IXDN414 to charge a 5000pF capacitive load from 0 to 25 volts in 25ns.

Using the formula:  $I = \Delta V C / \Delta t$ , where  $\Delta V = 25V$ ,  $C = 5000pF$  &  $\Delta t = 25ns$  we can determine that to charge 5000pF to 25 volts in 25ns will take a constant current of 5A. (In reality, the charging current won't be constant, and will peak somewhere around 8A).

### SUPPLY BYPASSING

In order for our design to turn the load on properly, the IXDN414 must be able to draw this 5A of current from the power supply in the 25ns. This means that there must be very low impedance between the driver and the power supply. The most common method of achieving this low impedance is to bypass the power supply at the driver with a capacitance value that is a magnitude larger than the load capacitance. Usually, this would be achieved by placing two different types of bypassing capacitors, with complementary impedance curves, very close to the driver itself. (These capacitors should be carefully selected, low inductance, low resistance, high-pulse current-service capacitors). Lead lengths may radiate at high frequency due to inductance, so care should be taken to keep the lengths of the leads between these bypass capacitors and the IXDN414 to an absolute minimum.

### GROUNDING

In order for the design to turn the load off properly, the IXDN414 must be able to drain this 5A of current into an adequate grounding system. There are three paths for returning current that need to be considered: Path #1 is between the IXDN414 and its load. Path #2 is between the IXDN414 and its power supply. Path #3 is between the IXDN414 and whatever logic is driving it. All three of these paths should be as low in resistance and inductance as possible, and thus as short as practical. In addition, every effort should be made to keep these three ground paths distinctly separate. Otherwise, the returning ground current from the load may develop a voltage that would have a detrimental effect on the logic line driving the IXDN414.

### OUTPUT LEAD INDUCTANCE

Of equal importance to Supply Bypassing and Grounding are issues related to the Output Lead Inductance. Every effort should be made to keep the leads between the driver and its load as short and wide as possible. If the driver must be placed farther than 2" (5mm) from the load, then the output leads should be treated as transmission lines. In this case, a twisted-pair should be considered, and the return line of each twisted pair should be placed as close as possible to the ground pin of the driver, and connected directly to the ground terminal of the load.

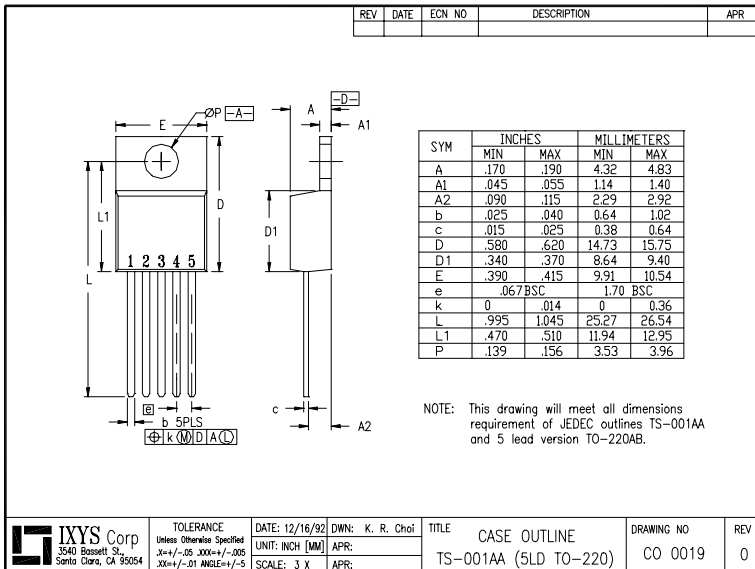
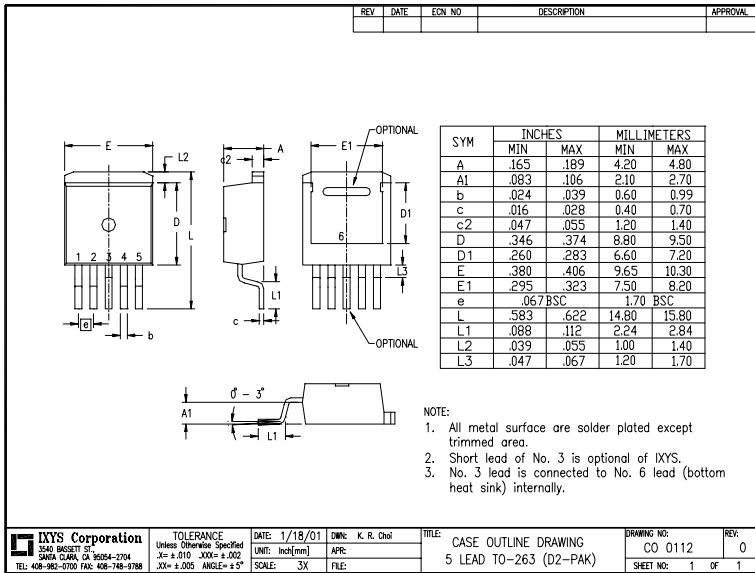
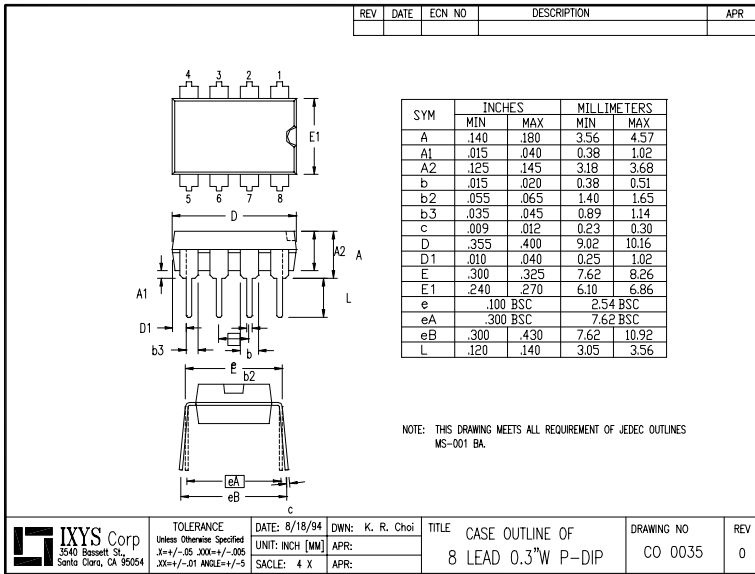

IXYS Corporation  
3540 Bassett St; Santa Clara, CA 95054  
Tel: 408-982-0700; Fax: 408-496-0670  
e-mail: sales@ixys.net  
www.ixys.com

IXYS Semiconductor GmbH  
Edisonstrasse 15 ; D-68623; Lampertheim  
Tel: +49-6206-503-0; Fax: +49-6206-503627  
e-mail: marcom@ixys.de

Directed Energy, Inc.  
An IXYS Company  
2401 Research Blvd. Ste. 108, Ft. Collins, CO 80526  
Tel: 970-493-1901; Fax: 970-493-1903  
e-mail: deiinfo@directedenergy.com  
www.directedenergy.com