

**ADVANCED RF PROCESSOR**

KIA2082F is an advanced RF processor for car tuners. An FM front end and AM tuner are internal parts are drastically reduced. Car tuners with both FM/AM require only the KIA2093F post-stage advanced FM processor and KIA2082F to realize a tuner with very high-quality performance.

**FEATURES**

- FM Front End Block
- Super Balanced mixer (Ermitter input)
- VCO
- VCO Buffer Output
- IF Amp
- Super NLA (Narrow Linear AGC)
- Band Select

**AM Tuner Block**

- Up Conversion Double Super Heterodyne
- Super Balance Mixer 1
- Super Balance Mixer 2
- VCO
- VCO Buffer Output
- Oscillator
- IF Amp
- 2 Supper AGC for RF Stage (delayed AGC)

- AM Detection.
- Narrow Band Signal Meter Output.
- IF count Output and IF Output for AM Stereo Decoder with Request.
- SD Output.
- 2 AGC for IF Stage.
- IF AGC speed-up.
- Built-in AGC over Reponse Improve Circuit.
- Operating Supply Voltage :  $V_{opr}=8\pm 1V$ .

**MAXIMUM RATINGS (Ta=25°C)**

CHARACTERISTIC	SYMBOL	RATING	UNIT
Supply Voltage	$V_{CC}$	10	V
Power Dissipation (Note)	$P_D$	890	mW
Operating Temperature	$T_{opr}$	-40~85	°C
Storage Temperature	$T_{stg}$	-55~150	°C
Pin <sup>②</sup> Flow Current	$I_{28}$	6	mA
Pin <sup>②</sup> Applied Voltage	$V_{(Req.)}$	6	V

(Note) When using at temperatures higher than 25°C, maximum power dissipation decreases by 7.12mW for every 1°C over 25°C. See Figure 1 for the relationship between the pwer dissipation and the ambient temperature when using.

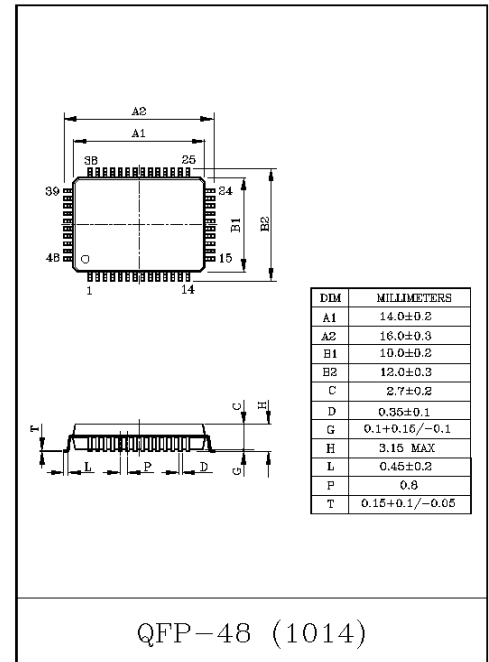

**Fig.1 POWER DISSIPATION ( $P_D$ )- OPERATING AMBIENT TEMPERATURE ( $T_a$ )**

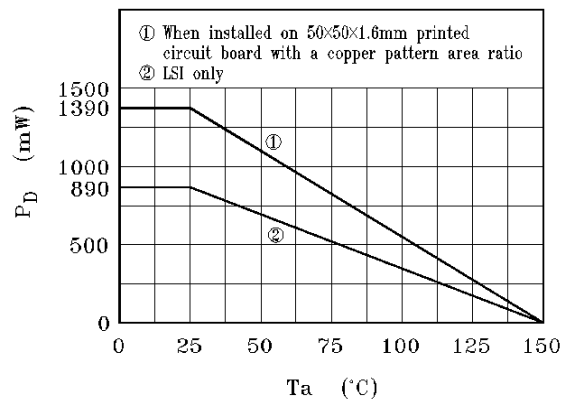

# KIA2082F

---

## FEATURES

### FM Front End Block

- The Balanced input-type mixers, which do not require a balun coil, offer improved intermodulation distortion while improving total IP by 12dB over the conventional level.
  - : Total IP $\approx$ 115dB $\mu$ V(Typ.) when 3SK195+KIA2082F.
- ...Jis dummy input terminal regulation
  - Replace the varactor with a fixed capacitor of a similar capacitance.
- Expands the IF amp dynamic range and improves AMR and tweet interference characteristics about 20dB $\mu$ V above the previous product. Therefore, the RF AGC sensitivity can be set as desired without AMR deterioration.
  - : Field strength where AMR deterioration starts  $\geq$ 90dB $\mu$ V(Typ.) (at RF AGC off)
- The pattern and wiring can be designed more freely because the VCO buffer output drivability is improved.
  - : With 680 $\Omega$ /15pF load,  $\approx$ 110dB $\mu$ V (Typ.)
- Incorporates an advanced NLA. The NLA uses the signal meter output (a means of detecting the field strength of the target station) to control the synthetic output from the wide AGC detected from the signal in the RF amp bandwidth and the middle AGC detected from the signal in the mixer bandwidth. This improves sensitivity rejection, the result of near-detuning interference, while improving the IM distortion over a wide range up to far-detuning interference.

### AM Tuner Block

- Because of the up conversion, KIA2082F is compatible with LW reception.
- Because of improved cross modulation distortion at balance mixer 1 and 2, and the effective AGC, the overall cross modulation distortion matches the distortion obtained by the down conversion.
  - : US  $\approx$ 21dB $\mu$ V (Typ.)
  - IP  $\approx$ 124dB $\mu$ V (Typ.)
  - : S/N  $\approx$ 8dB(Typ.) when Vd=40dB $\mu$ V EMF, Vu=120dB $\mu$ V EMF,  $\Delta$ F=40kHz
- Although the dynamic range is expanded without a ceramic resonator, the signal meter output operates without malfunction caused by far-detuning interference.
  - : Signal meter output dynamic range  $\approx$ 60dB(Typ.)
- The noise convergence can be set as desired.
- Supports an SD output pin for memory scan.
- The SD output and the IF count output are synchronized. The detection sensitivity for the field strength can be set anywhere within the signal meter output dynamic range.
- The request function operates at a seek and the IF system supports two types of AGC speed-up. Thus, the response of the distortion ratio, SD output, and IF count output are balanced at both low FM and high AM signal strengths.
  - : THD  $\approx$ -40dB(Typ.) at 100Hz, 80% AM.
  - : SD output and IF count output generation time  $\approx$ 12mS(Typ.)
- For compatibility with Motorola-type AM stereo reception, the C/N of the AM VCO is improved and the quality of stereo S/N matches the down conversion stereo S/N.
  - : S/N  $\approx$ 42dB(Typ.) When Vd=74dB $\mu$ V EMF, AM=400Hz/30%
  - : f<sub>CL</sub>=200Hz, -18dB/oct. wiggling
- The VCO buffer output is a single output pin type that is connected to both AM and FM VCOs by switching. External switches are not necessary. As with the FM front end block, pattern and wiring design freedom is improved because of the single output pin and better drivability.
  - : With 6.8k $\Omega$ /15pF load  $\approx$ 110dB $\mu$ V (Typ.)
- Oscillation tolerance in relation to the crystal oscillator is improved.
  - : With standard crystal, additional series resistance when the mixer gain starts to drop  $\approx$ 620 $\Omega$  (Typ.)

# KIA2082F

## BLOCK DIAGRAM

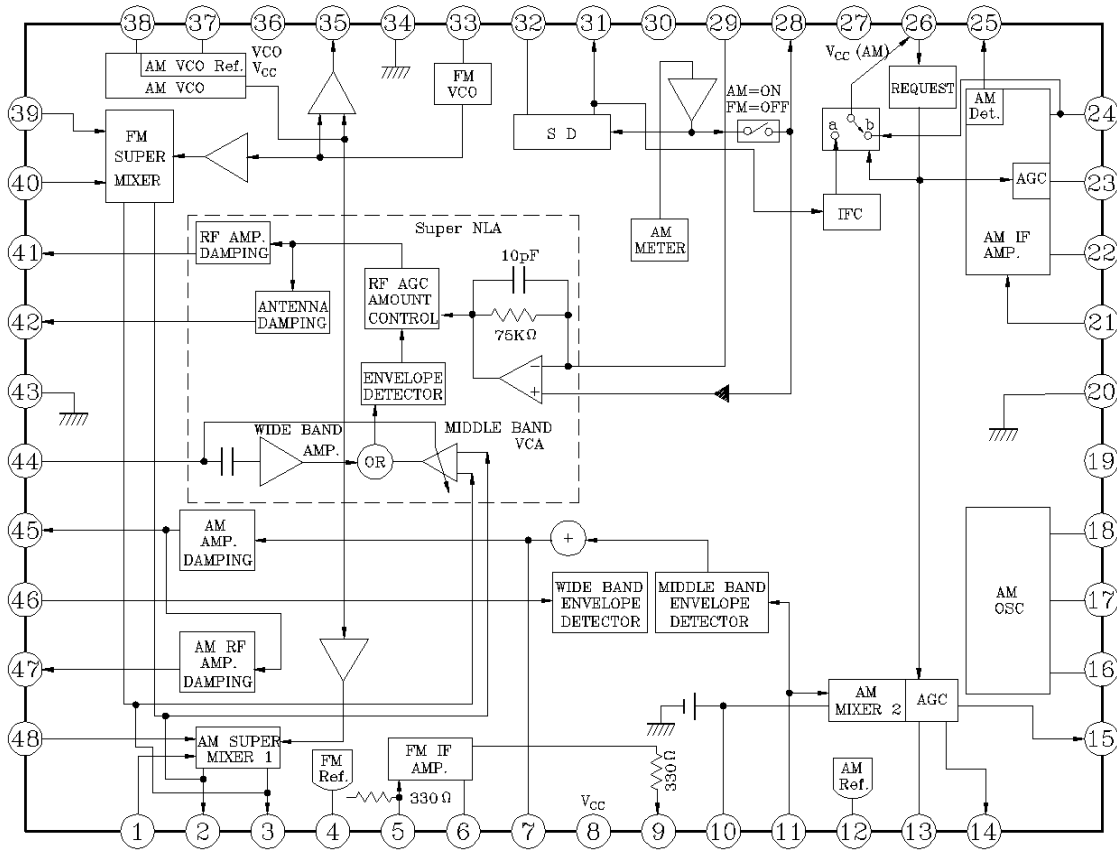

# KIA2082F

## PIN NAMES

PIN No.	PIN SYMBOL	PIN NAME
1	AM 1'st Mixer in 2	AM 1'st Mixer Input 2
2	Mixer-out 1	Mixer Output 1
3	Mixer-out 2	Mixer Output 2
4	FM Reference	Reference Voltage for FM
5	FM IF Amp-in	FM IF Amp Input
6	FM IF Amp-bypass	FM IF Amp bypass
7	AM RF AGC Trimer	AM RF AGC Trimer
8	V <sub>cc1</sub>	V <sub>cc1</sub>
9	FM IF A-out	FM IF Amp Output
10	AM 2'nd Mixer-bypass	AM 2'nd Mixer bypass
11	AM 2'nd Mixer-in	AM 2'nd Mixer Input
12	AM Reference 1	Reference Voltage 1 for AM
13	AM 2'nd Mixer AGC	AM 2'nd Mixer AGC
14	AM 2'nd Mixer out 1	AM 2'nd Mixer Output 1
15	AM 2'nd Mixer out 2	AM 2'nd Mixer Output 2
16	AM OSC Reference	Reference Voltage for AM OSC
17	AM OSC Bass	AM OSC Base
18	AM OSC Emitter	AM OSC Emitter
19	NC	NC
20	GND 2	GND 2
21	AM IF Amp-in	AM IF, Amp Input
22	AM NC Trimer	AM Noise convergence Trimer
23	AM IF AGC	AM IF Amp AGC
24	AM Detector	AM Detector
25	AM AF	AM Detector Output
26	AM Request	AM IF Count Request
27	V <sub>cc2</sub>	V <sub>cc2</sub>
28	AM Meter	AM Signal Meter Output
29	NCL Trimer	narrow Linear AGC Trimer
30	NC	NC
31	AM SD out	AM Station Detector Output
32	AM SD Trimer	AM Station Detector Trimer
33	FM V <sub>co</sub>	FM V <sub>co</sub>
34	VCO GND	GND for VCO
35	VCO out	VCO Output
36	VCO V <sub>cc</sub>	VCC for VCO
37	AM VCO Reference	Reference Voltage for AM VCO
38	AM VCO	AM VCO

# KIA2082F

---

## PIN NAMES

PIN No.	PIN SYMBOL	PIN NAME
39	FM Mixer in 1	FM Xixer Input 1
40	FM Mixer in 2	FM Xixer Input 2
41	FM AGC(FET) out	FM FET Damping Output
42	FM AGC(PIN) out	FM Anatenna Damping Output
43	GND. 1	GND
44	FM AGC Trimer	FM AGC Trimer
45	AM AGC(PIN) out	AM Antenna Damping Output
46	AM Wide AGC in	AM Wide AGC Input
47	AM AGC(FET) out	AM FET Damping Output
48	AM 1'st Mixer in 1	AM 1'st Mixer Input 1

# KIA2082F

## ELECTRICAL CHARACTERISTICS

FE Block (Unless otherwise specified,  $V_{CC}=V_{CC1}=8.5V$ ,  $V_{CC2}=0V$ ,  $T_a=25^{\circ}C$ ,  $f_i=98.1MHz$  CW,  $V_{IN}=110dB\mu V$ ,  $V_T \approx 3.5V$ ,  $V_{I(NLA)}=5V$ )

CHARACTERISTIC	SYMBOL	TEST CONDITION	MIN.	TYP.	MAX.	UNIT
Quiescent Current	$I_{CCQ}$	$V_{IN}=-20dB\mu V$	30	39	50	mA
Total Gain	$G_V$	, $V_{IN}=80dB\mu V$	25	28	31	dB
IF Maximum Output	$V_{OM(IF)}$	-	113	118	123	dB $\mu V$
VCO Output	$V_{OM(VCO \cdot FM)}$	$V_{IN}=80dB\mu V$	104	112	116	
Middle AGC Sensitivity	$V_{S(MAGC)}$	When $V_{O(Ant.)}=1.5V$	74	78	82	
Wide AGC Sensitivity	$V_{S(WAGC)}$	$f_i=100.1MHz$ CW	85	89	93	
NLA Sensitivity	$V_{S(NLA)}$	$V_{O(Ant.)}=3.0V$	1.5	1.7	1.9	V
Antenna Damping Max Output	$V_{CM(Ant.)}$	-	5.0	5.5	6.0	
FET Damping Saturation Output	$V_{OS(FET)}$	-	-	0.1	0.2	

AM Tuner Block (Unless otherwise specified,  $f_d=999kHz$ ,  $V_d=74dB\mu V$  EMF, AM=400Hz 30%,  $V_{CC}=V_{CC2}=8.5V$ ,  $T_a=25^{\circ}C$ ,  $V_T \approx 3V$ )

CHARACTERISTIC	SYMBOL	TEST CONDITION	MIN.	TYP.	MAX.	UNIT	
Quiescent Current Signal Input	$I_{CCQ}$	$V_d=-20dB\mu V$ EMF	50	61	76	mA	
Supply Current	$I_{CC}$	$V_d=130dB\mu V$ EMF CW					-
Detection Output	Signal	-	145	175	205	mV <sub>rms</sub>	
Signal to Noise Ratio	S/N	AM=400Hz 30%→0%	49	54	-	dB	
Total Harmonic Distortion Ratio	THD1	-	-	-52	-45	dB	
	THD2	AM=400Hz 80%	-	-47	-40	dB	
	THD3	$V_d=130dB\mu V$ EMF	AM=400Hz 80%	-	-42	-35	dB
	THD4		AM=100Hz 80%	-	-42	-	dB
Meter Output	$V_{M1}$	$V_d=20dB\mu V$ EMF	AM=0%	-	0.2	0.7	V
	$V_{M2}$	$V_d=60dB\mu V$ EMF		2.7	3.3	3.9	
	$V_{M3}$	$V_d=100dB\mu V$ EMF		40	4.4	5.0	
	$V_{M4}$	$V_d=120dB\mu V$ EMF		40	4.4	5.0	
Request Threshold	$V_{th(Req.)}$	When $V_{O(IFC)}=106dB\mu V$	0.8	1.1	1.4		
SD Sensitivity	$V_{S(SD)}$	$V_{O(SD)}=V_{CC}$	26	34	45	dB $\mu V$ EMF	
IF Count Output	$V_{O(IFC)}$	$V_{(Req.)}=0V$	104	106	110	dB $\mu V$ EMF	
IF Output	$V_{O(IF)}$	$V_{(Req.)} \rightarrow 5.0V$	104	106	110		
VCO Output	$V_{O(VCO \cdot AM)}$	-	108	113	117		
Usable Sensitivity	US	S/N=20dB, AM=400Hz, 30%→0%	-	23	-	dB $\mu V$ EMF	
Max Sensitivity	MS	Signal=-10dB	-	16	-	dB $\mu V$ EMF	
Noise Convergence	NC	0dB=Signal, $V_d=74 \rightarrow -20dB\mu V$ EMF	-	-34	-	dB	



# KIA2082F

## DESCRIPTION OF PIN FUNCTIONS

(Pin Voltage indicate standard values in the test circuit at  $V_{CC}=8.5V$ ,  $T_a=25^{\circ}C$  and no AC signal is input)

PIN No.	PIN NAME	PIN VOLTAGE(V) FM/AM	INTERNAL EQUIVALENT CIRCUIT/ INTERNAL STANDARD VALUE (INTERNAL R,C TYPICAL VALUES)	PIN FUNCTION
48	AM 1'st Mixer in 1	0/0.6		AM 1'st Mixer input terminal • External RF Amp. (ex. TOKO 7PD1249)
1	AM 1'st Mixer in 21	0/0.6		FM Mixer and AM 1'st Mixer output terminal. • External 10.7MHz IFT (ex. TOKO 7KLL7170D) • External ceramic filter for FM, AM via PIN diode (ex. TSB 1SV237) • AM 1'st Mixer is to be stopped at FM • FM 1'st Mixer is to be stopped at AM
2	Mixer-out1	8.5/8.5		
3	Mixer-out2	8.5/8.5		
4	FM Reference	4.1/0		Reference voltage source for FM. • External capacitance • 0V, stop FM operating at AM mode.
5	FM IF Amp-in	1.9/0		FM IF Amp. input terminal. • External ceramic filter
6	FM IF Amp -bypass	1.9/0		FM IF Amp. input bypass terminal. • External capacitance
9	FM IF Amp-out	3.4/7.7		FM IF Amp. output terminal. • External ceramic filter



# KIA2082F

PIN No.	PIN NAME	PIN VOLTAGE(V) FM/AM	INTERNAL EQUIVALENT CIRCUIT/ INTERNAL STANDARD VALUE (INTERNAL R,C TYPICAL VALUES)	PIN FUNCTION
7	AM RF AGC Trimier	0/0.2		AM RF AGC smoothing, sensitivity adjust terminal. • External C, R. • R(↑), R AGC sensitivity(↑) • Starting point ≈ 3.0V
8	V <sub>cc1</sub>	8.5/8.5		V <sub>cc</sub> fro FM NLA, IF Amp., AM 1'st Mixer, AM 2'nd Mixer, OSC
10	AM 2'nd Mixer -bypass	0/3.4		AM 2'nd Mixer input bypass terminal. • External C to ground point of external ceramic filter.
11	AM 2'nd Mixer -in	0/3.4		AM 2'nd Mixer input terminal. • External ceramic filter. • Matching R between pin 10
12	AM Reference 1	0/5.7		1'st ref. voltage source for AM. • External C
13	AM 2'nd Mixer AGC	0/5.1		AM 2'nd Mixer output terminal AGC smoothing terminal. • Time constant shorten at seek • External C between pin ⑫

# KIA2082F

PIN No.	PIN NAME	PIN VOLTAGE(V) FM/AM	INTERNAL EQUIVALENT CIRCUIT/ INTERNAL STANDARD VALUE (INTERNAL R,C TYPICAL VALUES)	PIN FUNCTION
14	AM 2'nd Mixer out 1	8.5/8.5		AM 2'nd Mixer output. • External 450kHz IFT, damping R
15	AM 2'nd Mixer out 2	8.5/8.5		
16	AM OSC Reference	0/5.0		Reference voltage source. • External C
17	AM OSC-Base	0/4.3		AM OSC, oscillation terminal. • External X'tal (KINSEKI HC-49/U-S) and positive feed back C
18	AM OSC -Emitter	0/3.6		Feed back terminal for AM OSC. • External C
20	GND 2	0/0		Gnd. for 2'nd MIX, OSC, IF Amp., Detector, Meter, SD, ref., power source.



# KIA2082F

PIN No.	PIN NAME	PIN VOLTAGE(V) FM/AM	INTERNAL EQUIVALENT CIRCUIT/ INTERNAL STANDARD VALUE (INTERNAL R,C TYPICAL VALUES)	PIN FUNCTION
26	AM Request	0/2.3 or 2.9		<p>AM IF count out request terminal.</p> <ul style="list-style-type: none"> <li>• Pull down to less than 2.0V: request for IF count out and SD output. 2'nd Mixer AGC and IF AGC response time shorter.</li> <li>• Pull up to more than 2.0V : If output (106dBμV) for AM stereo Decoder (ex:MOTOROLA MC13020VM) is require at pin<sup>26</sup> and be able to direct coupling by external C.</li> <li>• Both output require an electric field at large the level of seek sensitivity</li> </ul>
31	AM SD out	0/8.5		<p>AM station detector SD output terminal.</p> <ul style="list-style-type: none"> <li>• External pull up <math>R \geq 10k\Omega</math></li> </ul>
32	AM SD Trimer	0/1.0		<p>AM station detector seek sensitivity adjust terminal.</p> <ul style="list-style-type: none"> <li>• External variable R etc.</li> <li>• IF count output and SD output are to go to stand by state with meter output(pin<sup>26</sup>) higher than this adjusted voltage.</li> </ul>
33	FM VCO	2.5/0.4		<p>FM VOC OSC terminal.</p> <ul style="list-style-type: none"> <li>• External OSC coil etc.</li> </ul>
34	VCO GND	0/0		GND FM VOC, AM VCO.
35	VCO out	5.4/5.4		FM VCO, AM VCO output terminal
36	VCO V <sub>cc</sub>	8.5/8.5		FM VCO, AM VCO, VCO buffer power supply.
37	AM VCO Reference	0/5.7		Ref. voltage for am VCO.
38	AM VCO	0/5.7		AM VCO oscillation terminal.
				• External OSC coil
39	FM Mixer in 1	2.4/0		<p>FM Mixer input terminal.</p> <ul style="list-style-type: none"> <li>• External C-couple RF tuning coil etc.</li> </ul>
40	FM Mixer in 2	2.4/0		

# KIA2082F

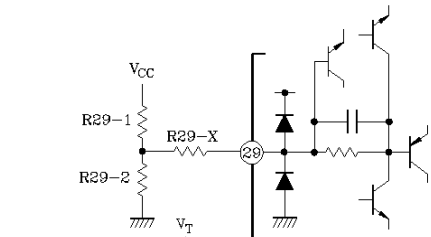
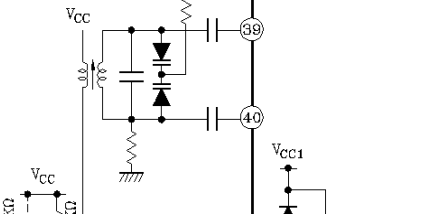
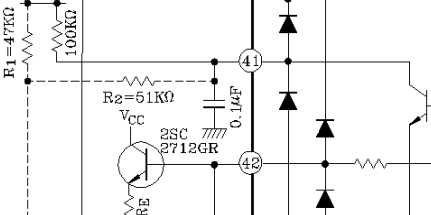
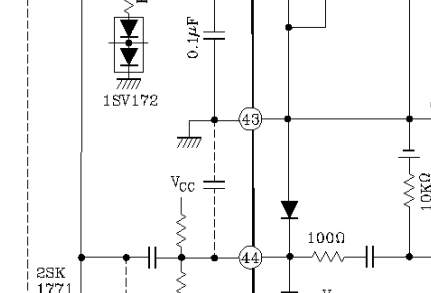
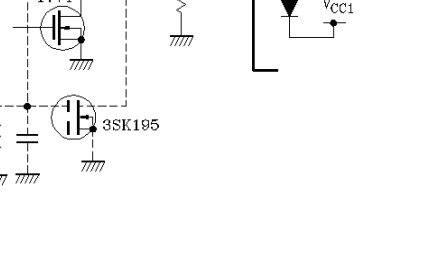
PIN No.	PIN NAME	PIN VOLTAGE(V) FM/AM	INTERNAL EQUIVALENT CIRCUIT/ INTERNAL STANDARD VALUE (INTERNAL R,C TYPICAL VALUES)	PIN FUNCTION
41	FM AGC (FET) out	8.5/0		<p>FET damping output terminal</p> <ul style="list-style-type: none"> <li>External pull up <math>R \geq 22k\Omega</math>, C-MOS FET.</li> <li>Damping with same timing of antenna damping by PIN diode.</li> </ul>
42	FM AGC (PIN) out	0.2/0.3		<p>FM antenna damping PIN diode (ex KDV173) drive terminal.</p> <ul style="list-style-type: none"> <li>External Tr(KTC2712GR) for current amplifying and smoothing C.</li> <li>Damping with same timing of FET damping.</li> </ul>
43	GND. 1	0/0		<p>FM NAL, FM Ref., FM IF Amp. 1AM 1'st Mix AM RF AGC GND.</p>
44	FM AGC Trimer	0/0		<p>AC : AGC input terminal (RF signal input)</p> <ul style="list-style-type: none"> <li>External C, C' for sensitivity adjustment.</li> <li>AGC start at 83dBμV</li> </ul> <p>DC : NLA (linear AGC control) input terminal.</p>
29	NLA Trimer			<ul style="list-style-type: none"> <li>NLA Trimer Terminal</li> <li>KIA2093F Meter output is as NLA input</li> <li>NLA start at 1.5V dc</li> <li>Improve 2 and 3 signals interference.</li> </ul>

# KIA2082F

PIN No.	PIN NAME	PIN VOLTAGE(V) FM/AM	INTERNAL EQUIVALENT CIRCUIT/ INTERNAL STANDARD VALUE (INTERNAL R,C TYPICAL VALUES)	PIN FUNCTION
45	AM AGC (PIN) out	0/0		AM antenna damping PIN diode (ex KDV173) drive terminal.
46	AM Wide AGC in	0/8.4		Wide band AGC input terminal for RF signal input. <ul style="list-style-type: none"> <li>• Connect to Rc at collector of J-FET cascade Tr.</li> <li>• AGC start at 108dB<math>\mu</math>V</li> <li>• Rc(<math>\downarrow</math>) : AGC sensitivity(<math>\downarrow</math>)</li> </ul>
47	AM AGC (FET) out	0/5.5		J-FET damping output terminal. <ul style="list-style-type: none"> <li>• External J-FET cascade Tr (KTC2712) and smoothing C.</li> <li>• Damping with same timing of antenna damping by PIN diode.</li> </ul>

# KIA2082F

## APPLICATION CIRCUIT (RF PROCESSOR BLOCK)

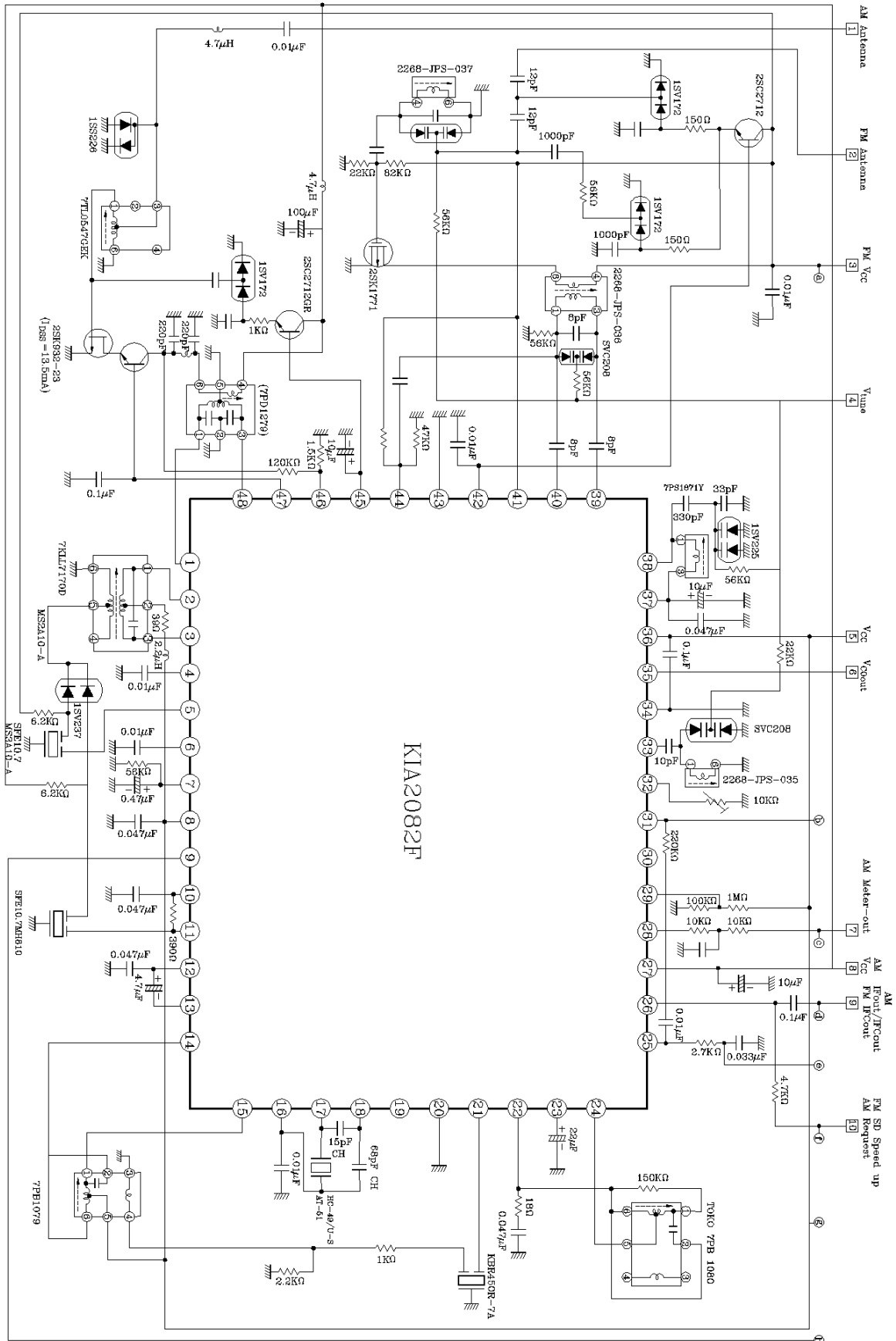

# KIA2082F

## APPLICATION CIRCUIT (FM PROCESSOR BLOCK)

