

FM NOISE CANCELLER FOR CAR AUDIO

The KIA6010SN is FM noise canceller IC. It built in LPF and HPF. The space merit is improved. It suitable for FM CAR radio.

APPLICATION

- Noise Detection
- Noise AGC
- FM Noise Canceller
- Signal Delay
- Adjustment Free Pilot Canceller
- Signal Holding
- Operating Supply Voltage : $V_{CC}=8\pm 1V$
- Recommended Main Signal Frequency : $f \leq 76kHz$

MAXIMUM RATINGS (Ta=25°C)

CHARACTERISTIC	SYMBOL	RATING	UNIT
Supply Voltage	V_{CC}	10	V
Power Dissipation (Note)	P_D	750	mW
Operating Temperature	T_{opr}	-40~85	°C
Storage Temperature	T_{stg}	-55~150	°C

Note : Derated above Ta=25°C in the Proportion of 6mW/°C for KIA6010SN

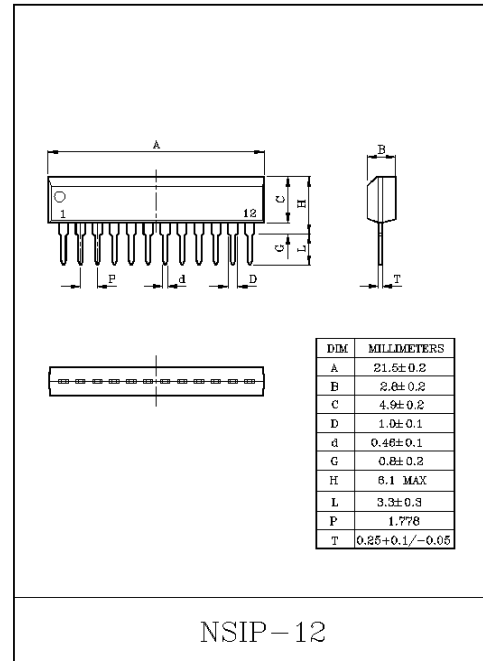

BLOCK DIAGRAM

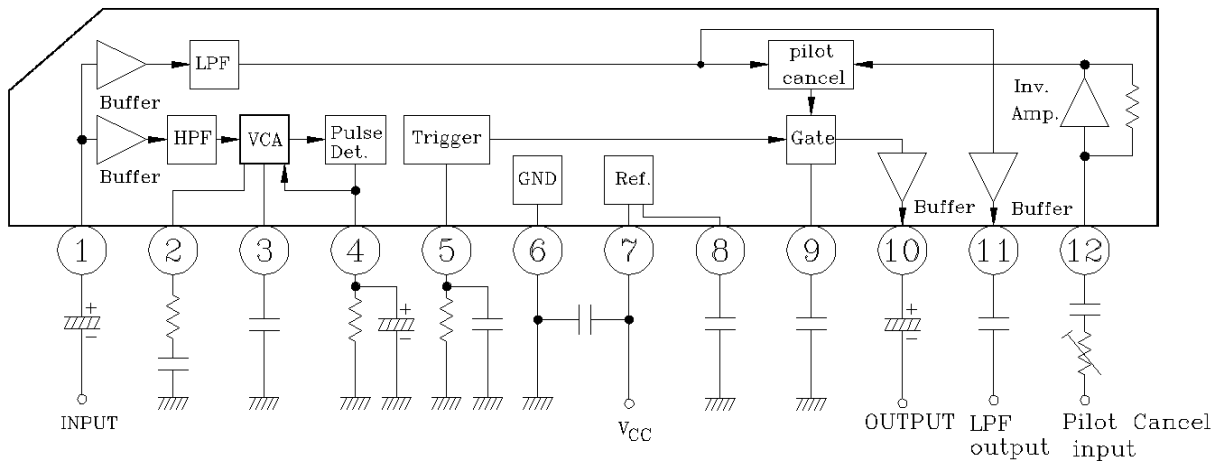

KIA6010SN

ELECTRICAL CHARACTERISTICS

(Unless otherwise specified, ($V_{CC}=8V$, $T_a=25^{\circ}C$, $f_{IN}=1kHz$, $V_{IN}=400mV$, $SW1=A$, $SW2=OFF$))

CHARACTERISTIC	SYMBOL	TEST CONDITION	MIN.	TYP.	MAX.	UNIT
Quiescent Supply Current	I_{CCQ}	$V_{IN}=0$	4.5	7	9.5	mA
Transfer Gain 1	G_{V1}		-1	0	1	dB
Transfer Gain 2	G_{V2}	$f_{IN}(\text{Pilot})=19kHz$ $V_{IN}(\text{Pilot})=40mV_{rms}$	-1.5	-0.5	0.5	dB
Total Distortion Ratio	THD		-70	-77	-	dB
Permissible Input	$V_{IN(\text{Max.})}$	THD=40dB	1000	1600	-	mV
Signal to Noise Ratio	S/N 1	$V_{IN}=400mV \rightarrow 0$	81	87	-	dB
Signal to Residual Pilot Ratio	S/N 2	$V_{IN}=360mV(1kHz) \rightarrow 40mV(19kHz)$ $SW2=off \rightarrow on$, $f_{IN}(\text{Pilot})=19kHz$ $V_{IN}(\text{Pilot})=40mV$	40	53	-	dB
Signal to Residual Pilot Ratio	S/N 3	$SW1=A \rightarrow B$ $A+A: V_{IN}=400mV$ $A+B: V_{IN}(\text{Pulse})=100mV_{pp}$ $f_{IN}=1kHz$, $tW=10\mu S$	68	77	-	dB
Pulse Noise Detection Sensitivity	VS (Pulse)	$SW1=B$, $f_{IN}=1kHz$, $tW=10\mu S$	-	50	-	mVp-o
Gate Open Time	t_G	$V_{IN}(\text{Pulse})=100mV_{pp}$	-	33	-	μS

KIA6010SN

DESCRIPTION ON TERMINALS

(Terminal Voltage shows the value at $V_{CC}=8V$, $T_a=25^{\circ}C$, and non-signal in measuring circuit)

Pin NO.	Terminal Name	Terminal Voltage (V)	Internal Equivalent Circuit/Typical Value of External Part (Resistance and capacity show the typical value)	Terminal Functions
1	NC _{in}	3.0		<ul style="list-style-type: none"> •Input Terminal •Connect a Capacitor
8	Ref	3.0		<ul style="list-style-type: none"> •Reference Voltage Terminal •Connect a Capacitor
2	NF	3.0		<ul style="list-style-type: none"> •AGC AMP NF Terminal •Noise AGC high sensitivity by a small resistor value.
3	Bypass	2.3		<ul style="list-style-type: none"> •Noise AMP bypass Terminal •Connect a capacitor

KIA6010SN

Pin NO.	Terminal Name	Terminal Voltage (V)	Internal Equivalent Circuit/Typical Value of External Port (Resistance and capacity show the typical value)	Terminal Functions
4	AGC	0		<ul style="list-style-type: none"> • Adjustment of a Noise AGC • Time Constant • Connect a capacitor and a resistor • Have a good effect on a noise with a large periodicity by a large resistor value.
5	PW	0		<ul style="list-style-type: none"> • Adjustment of a Trigger Pulse width. • Connect a capacitor and a resistor (A large resistor value is to widen a pulse width)
6	GND	0		<ul style="list-style-type: none"> • GND
7	B	8.0		<ul style="list-style-type: none"> • Power Supply • Connect a capacitor
9	Gate	3.8		<ul style="list-style-type: none"> • Composite Signal Holding Terminal • Connect a capacitor

KIA6010SN

Pin NO.	Terminal Name	Terminal Voltage (V)	Internal Equivalent Circuit/Typical Value of External Port (Resistance and capacity show the typical value)	Terminal Functions
10	NCout	2.4		<ul style="list-style-type: none"> • Output Terminal • Connect a phase Correction Circuit to set a maximum Separation Characteristic
11	LPFout	3.0		<ul style="list-style-type: none"> • LPF Output Terminal • Signal Supply to pilot-in Terminal for next stage. MPX IC KIA6030Z
12	Pilot-in	3.0		<ul style="list-style-type: none"> • input signal 19kHz is input to MPX IC KIA6030Z of the next stage. (Pilot signal 19kHz is Equal phase triangular) • Connect C, VR to get a Maximum pilot canceller by adjust R_{pc}.

KIA6010SN

$I_{CC} - V_{CC}$

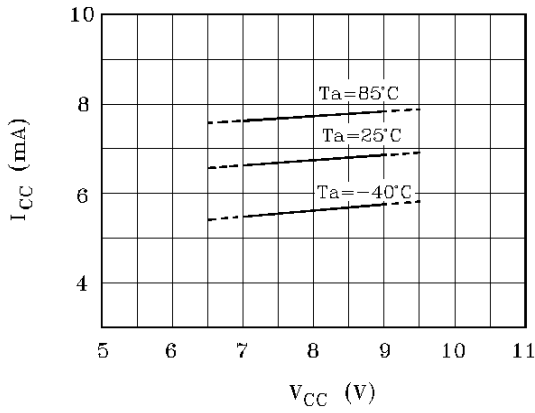

$V_0 - V_I$

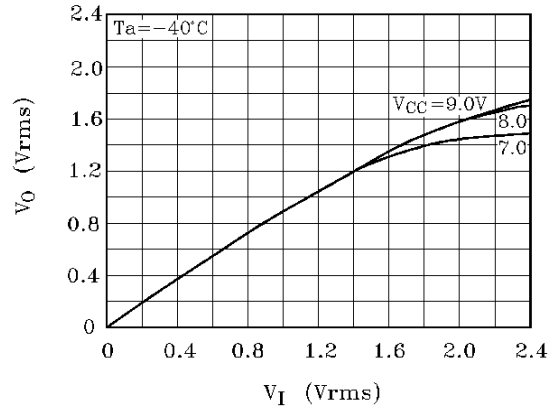

HPF

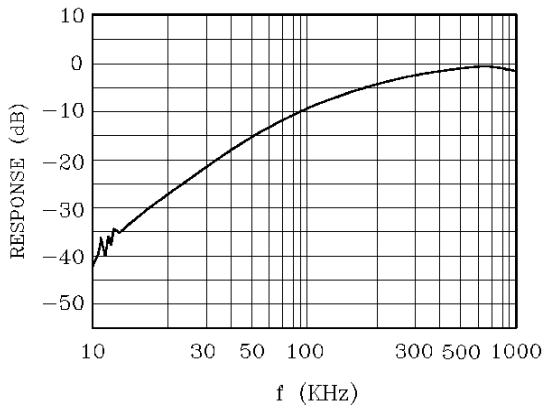

$V_0 - V_I$

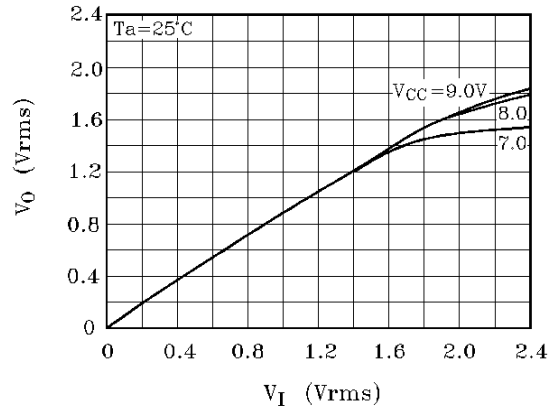

LPF

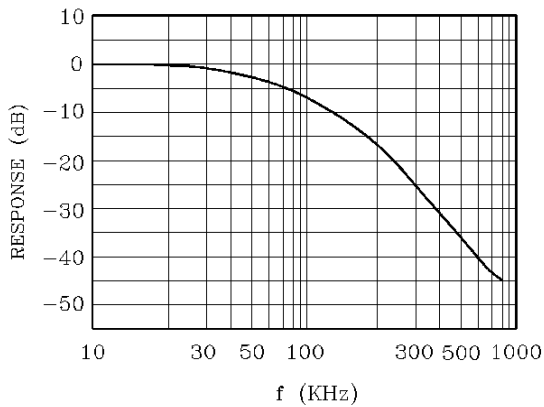

$V_0 - V_I$

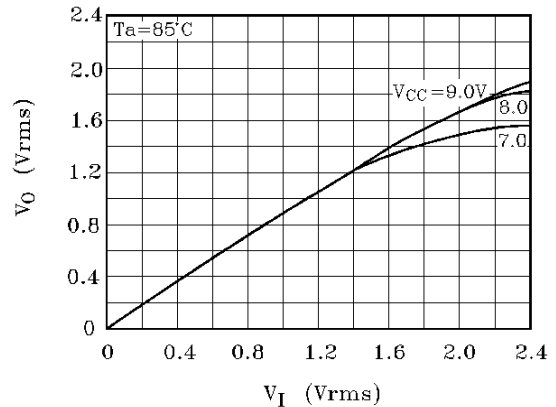

KIA6010SN

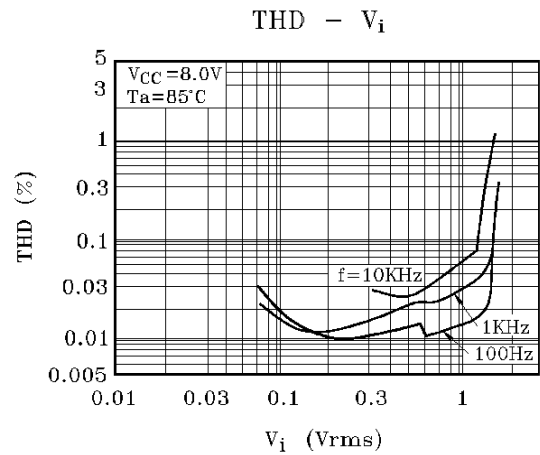
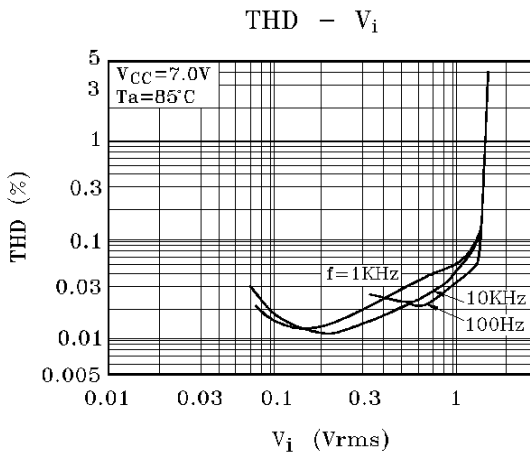
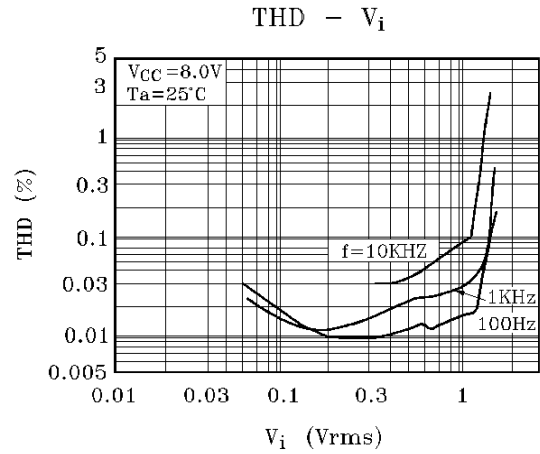
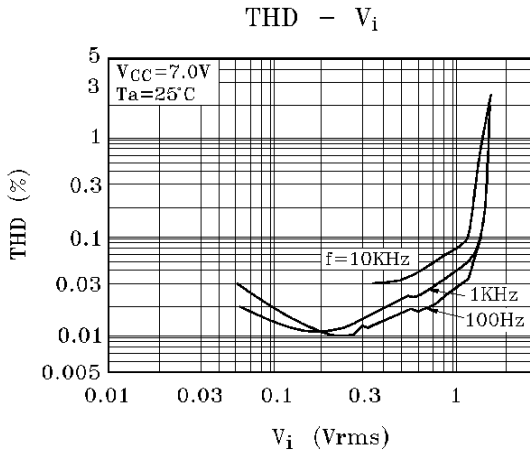
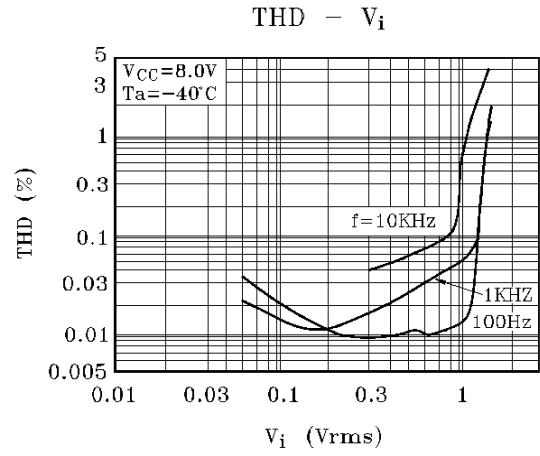
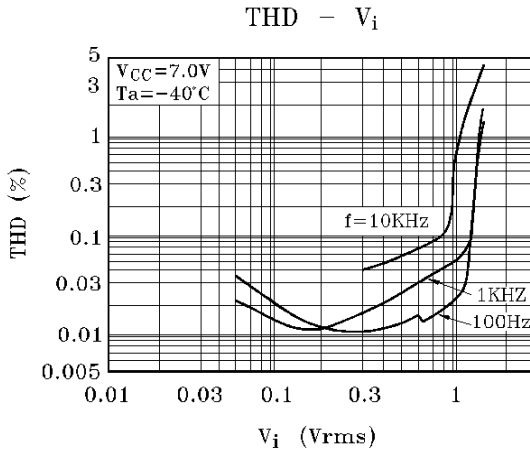

KIA6010SN

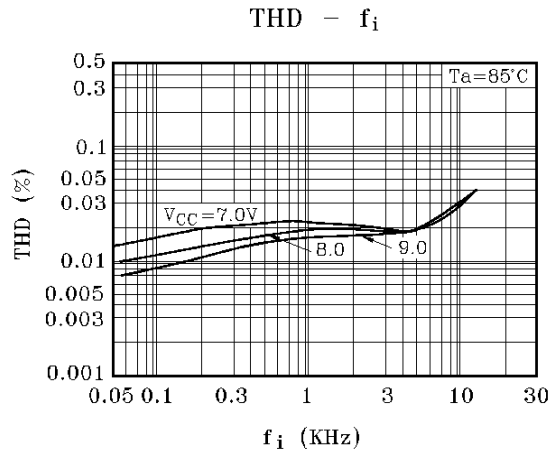
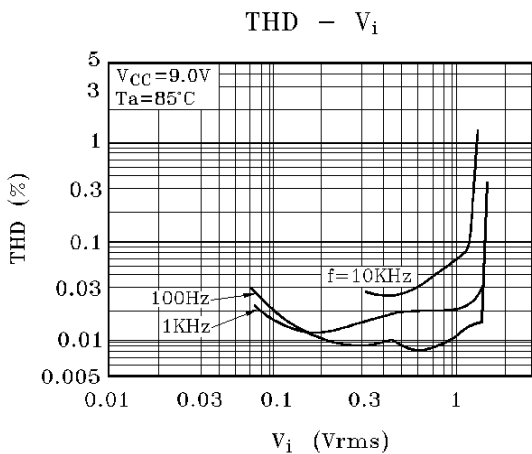
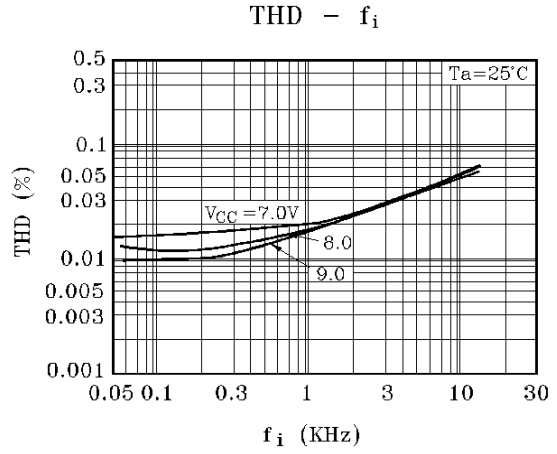
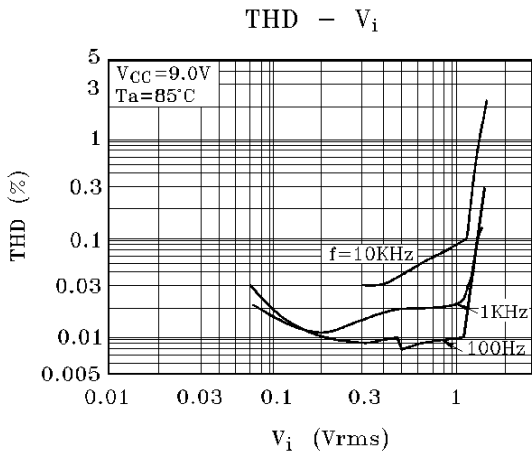
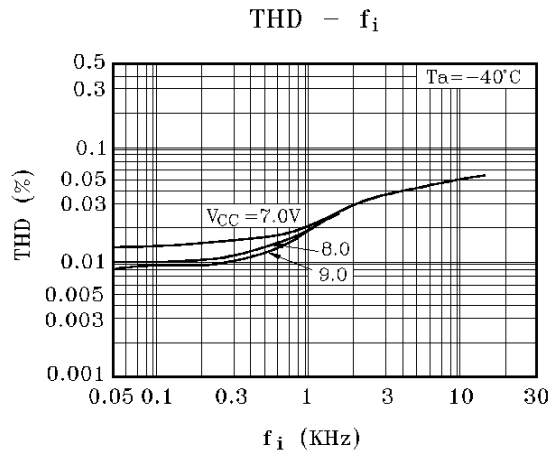
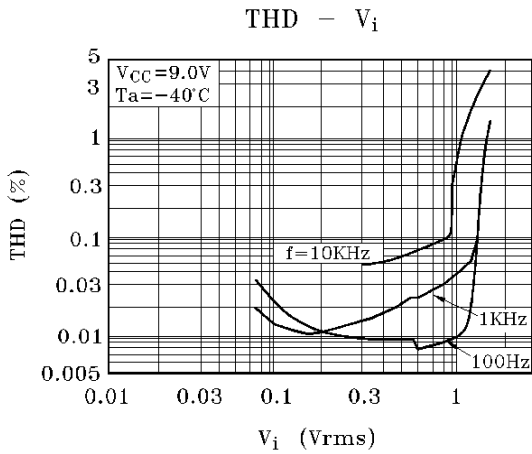

KIA6010SN

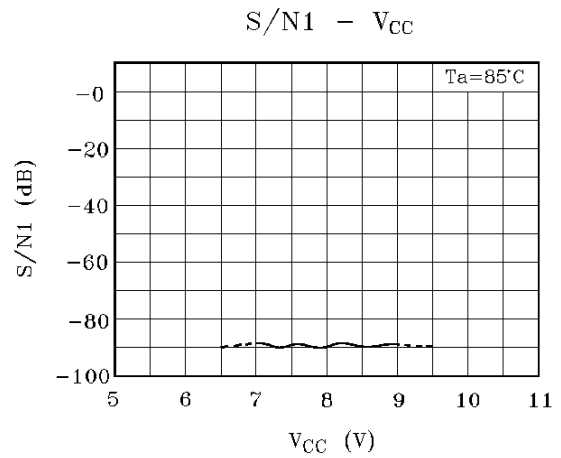
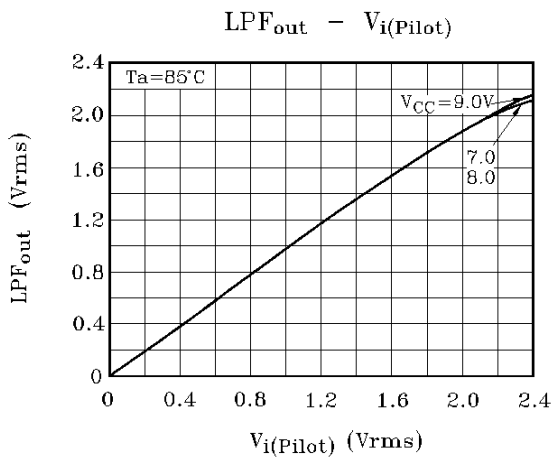
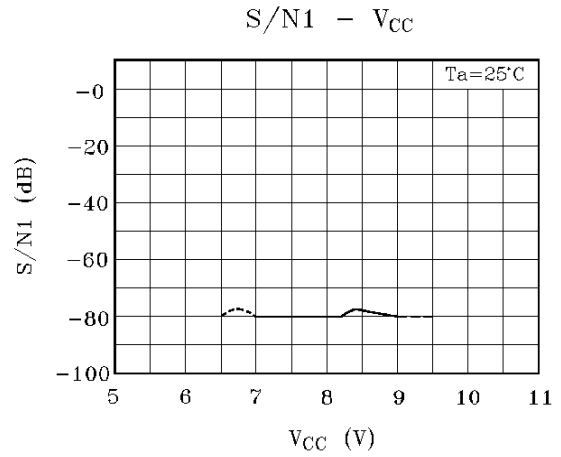
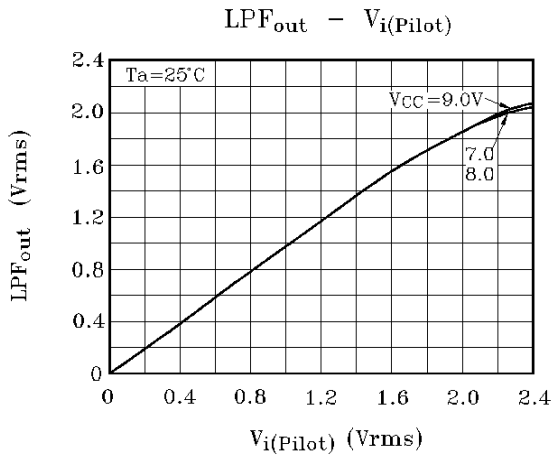
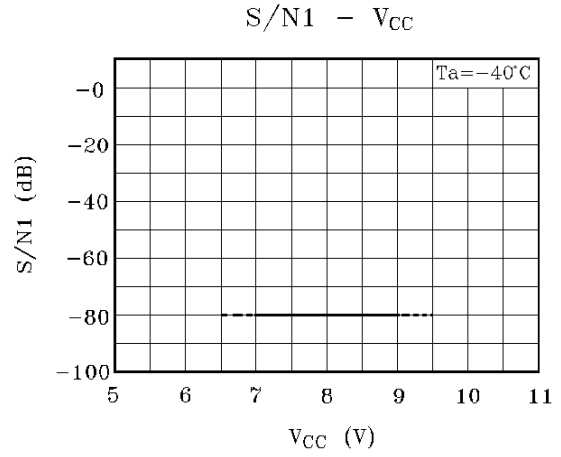
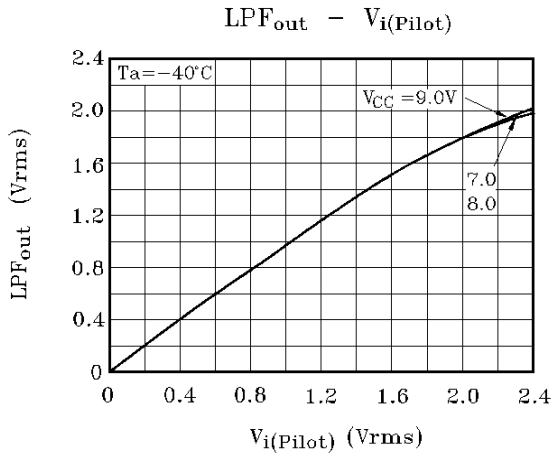

KIA6010SN

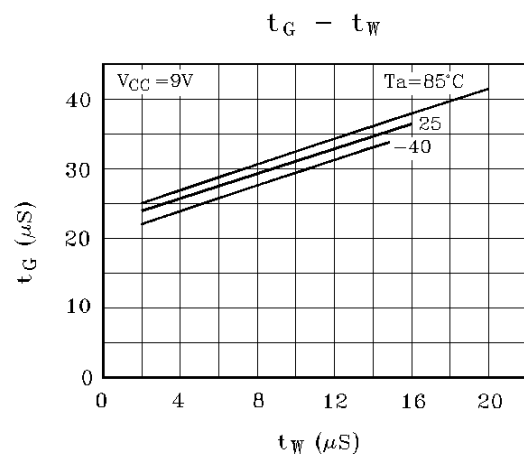
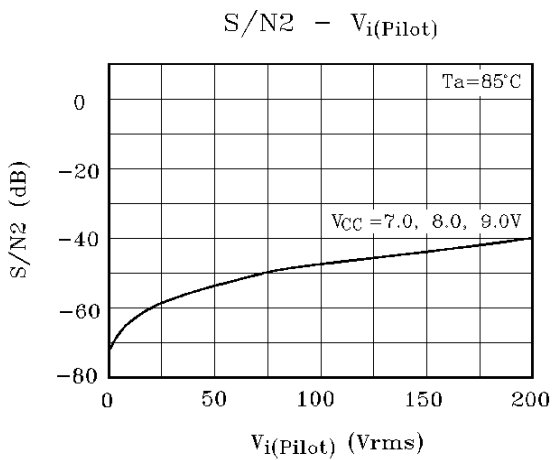
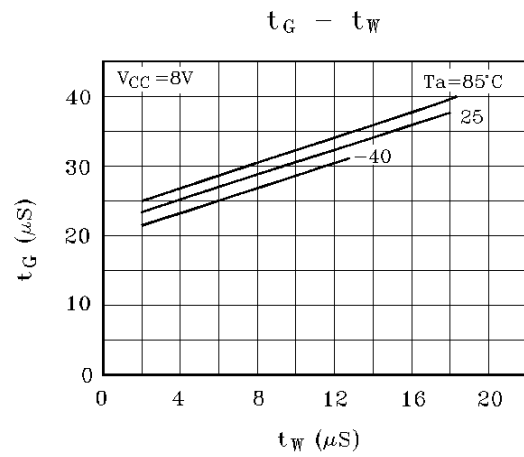
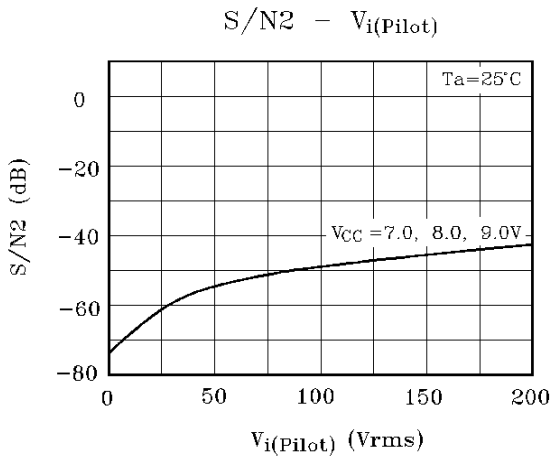
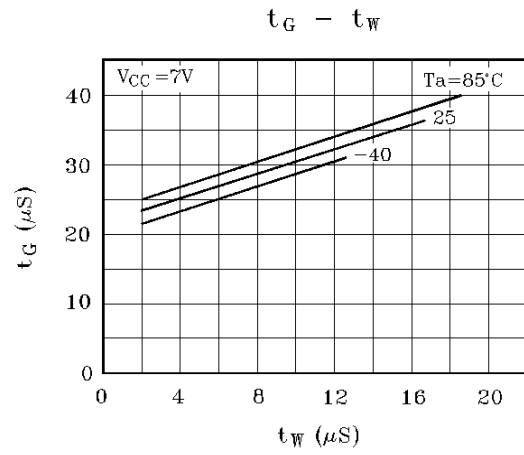
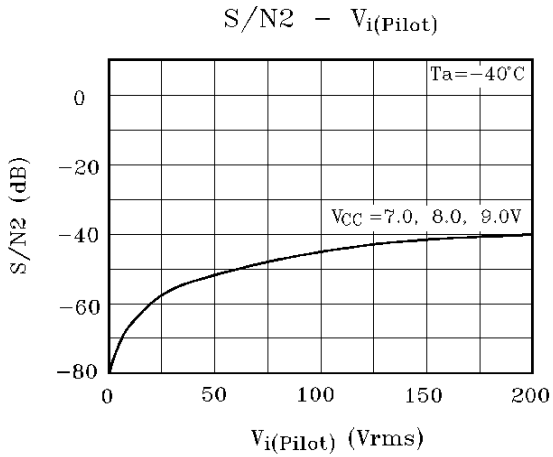

KIA6010SN

