

BI-DIRECTIONAL DC MOTOR DRIVER

KIA6801K is a monolithic integrated circuit designed for driving bi-directional DC motor with braking and speed control, and suitable for the loading motor driver of VCR, Cassette tape recorders systems. The speed control can be achieved by adjusting the external voltage of the speed control pin.

FEATURES

- Brake is applied when stopping the motor.
- Built-in Function absorb rush current generated by reversing and braking.
- Power transistor can handle a large current (1.6A Max.)
- External motor speed control pin.
- Stable operation during mode changes either from forward to reverse or vice versa.
- Interfaces with CMOS devices.
- Operation supply voltage range : $V_{CC}=6.0\sim 18V$.

MAXIMUM RATINGS ($T_a=25^\circ C$)

CHARACTERISTIC	SYMBOL	RATING	UNIT
Supply Voltage	V_{CC}	18	V
Output Current	I_{OUT}	1.6 (*1)	A
Power Dissipation	P_D	2.2 (*2)	W
Input Voltage	V_{IN}	$-0.3\sim V_{CC}$	V
Operating Temperature	T_{opr}	$-25\sim 75$	$^\circ C$
Storage Temperature	T_{stg}	$-55\sim 125$	$^\circ C$

Note) (*1) : Duty 1/100, pulse width 500

(*2) : Derated above $T_a=25^\circ C$ in the proportion of 10mW/ $^\circ C$

BLOCK DIAGRAM

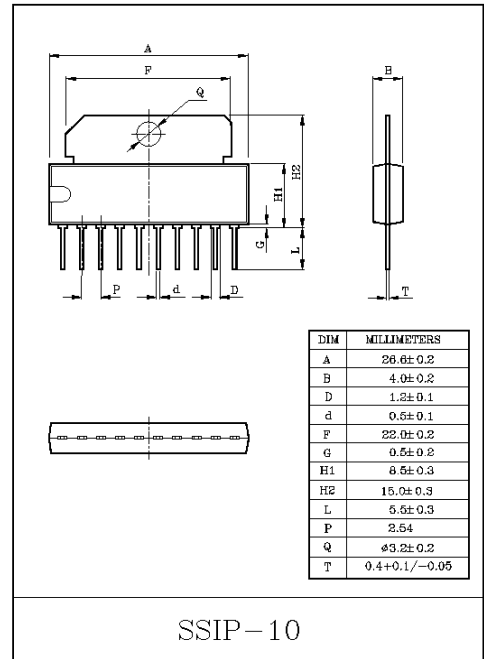
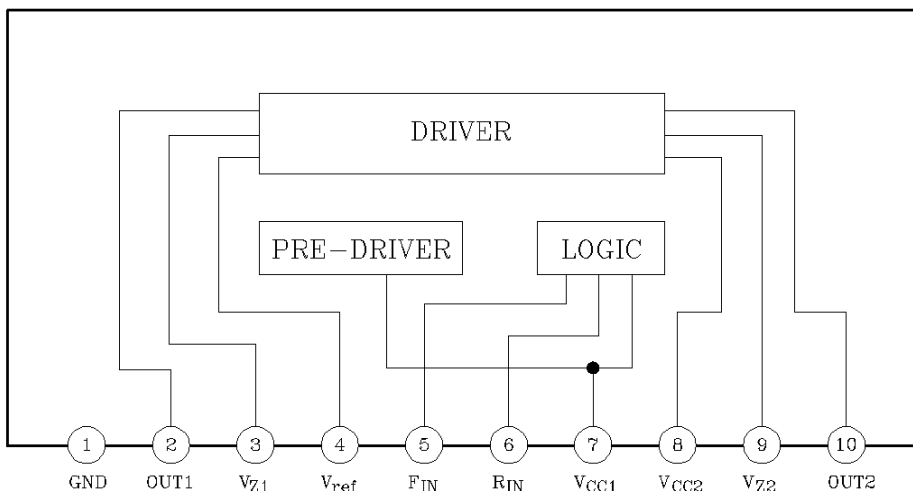

KIA6801K

ELECTRICAL CHARACTERISTICS

(Unless otherwise specified, $T_a=25^{\circ}\text{C}$, $V_{CC}=12\text{V}$)

CHARACTERISTIC		SYMBOL	TEST CONDITION	MIN.	TYP.	MAX.	UNIT
Operating Supply Voltage		V_{CC}		6	12	18	V
Quiescent Current		I_{CCQ}	Pin 5 & 6 : GND, $R_L=\infty$	3	5.5	10	mA
Min. Input-on Current		I_{IN1}	$R_L=\infty$, Pin 5= I_{IN1} , Pin 6=L	-	10	50	μA
		I_{IN2}	$R_L=\infty$, Pin 5=L, Pin 6= I_{IN2}	-	10	50	
Input Threshold Voltage		V_{INTH1}	$R_L=\infty$, Pin 5= V_{INTH1} , Pin 6=L	0.7	1.3	2.0	V
		V_{INTH2}	$R_L=\infty$, Pin 5=L, Pin 6= V_{INTH2}	0.7	1.3	2.0	
Output Leakage Current		I_{OL1}	$R_L=\infty$, Pin 5 & 6=GND	-	-	1	mA
		I_{OL2}	$R_L=\infty$, Pin 5 & 6=GND	-	-	1	
Zener Current		I_{Z1}	$R_L=10\Omega$, Pin 5=H, Pin 6=L	-	0.85	1.5	mA
		I_{Z2}	$R_L=10\Omega$, Pin 5=L, Pin 6=H	-	0.85	1.5	
Output Voltage		V_{O1}	$R_L=60\Omega$, Pin 5=H, Pin 6=L, $Z_D=7.4\text{V}$	6.6	7.2	-	V
		V_{O2}	$R_L=60\Omega$, Pin 5=L, Pin 6=H, $Z_D=7.4\text{V}$	6.5	7.1	-	
Saturation voltage	(PIN 10-1)	V_{CE10-1}	$R_L=R_C=\infty$, Pin 5=H, Pin 6=L, $I_{SINK}=100\text{mA}$	-	0.83	1.5	V
	(PIN 2-1)	V_{CE2-1}	$R_L=R_C=\infty$, Pin 5=L, Pin 6=H, $I_{SINK}=100\text{mA}$	-	0.83	1.5	
	(PIN 8-2)	V_{CE8-2}	$R_L=R_C=\infty$, Pin 5=H, Pin 6=L, $I_{SOURCE}=100\text{mA}$	-	0.83	1.5	
	(PIN 8-10)	V_{CE8-10}	$R_L=R_C=\infty$, Pin 5=L, Pin 6=H, $I_{SOURCE}=100\text{mA}$	-	0.83	1.5	

KIA6801K

PIN CONFIGURATIONS

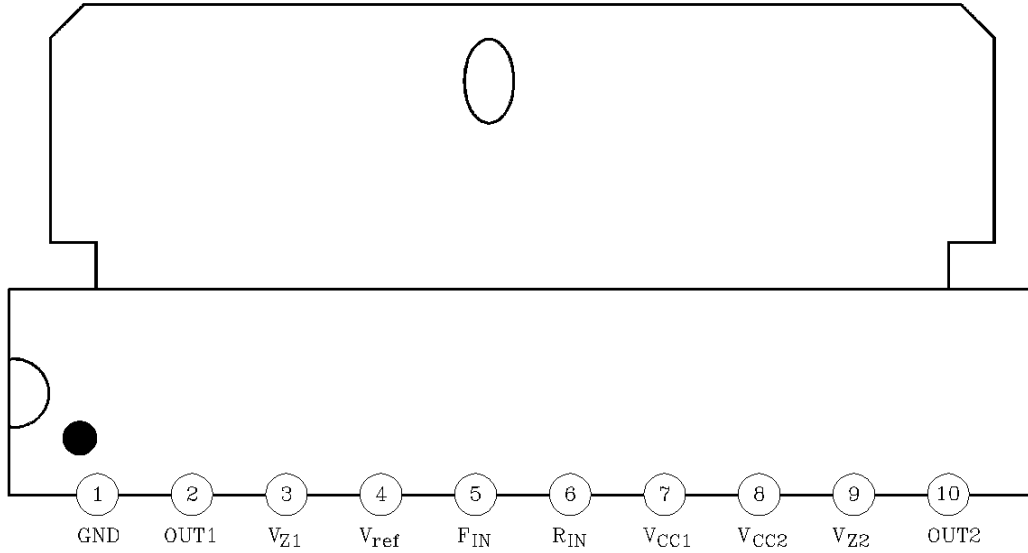

PIN DESCRIPTIONS

Pin No.	SYMBOL	DESCRIPTION
1	GND	Ground.
2	Out 1	Motor Output Pin.
3	V _{Z1}	Capacitor Connection Pin for Preventing Both Output Transistor Being Turned on at the same time.
4	V _{ref}	Output High Voltage Setting Pin.
5	F _{IN}	Logic Input Pin.
6	R _{IN}	Logic Input Pin.
7	V _{CC1}	Control Circuit Power Supply Pin.
8	V _{CC2}	Output Power Supply Pin.
9	V _{Z2}	Capacitor Connection Pin for Preventing Both Output Transistors Being Turned on at the same time.
10	Out2	Motor Output Pin.

KIA6801K

TEST CIRCUIT

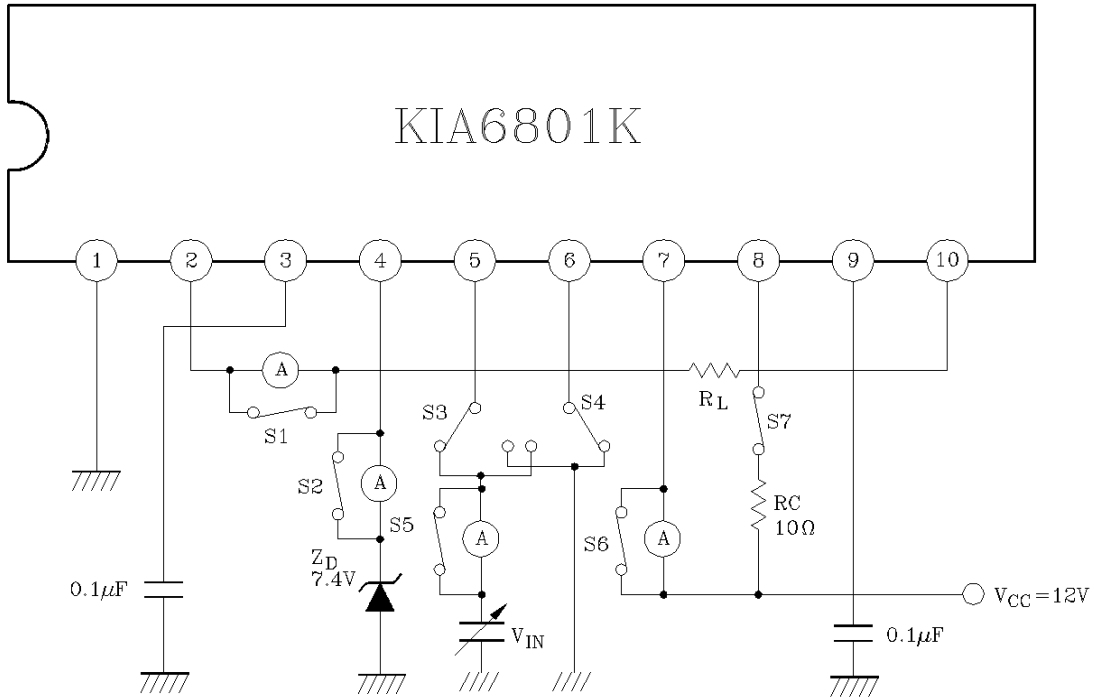

APPLICATION CIRCUIT

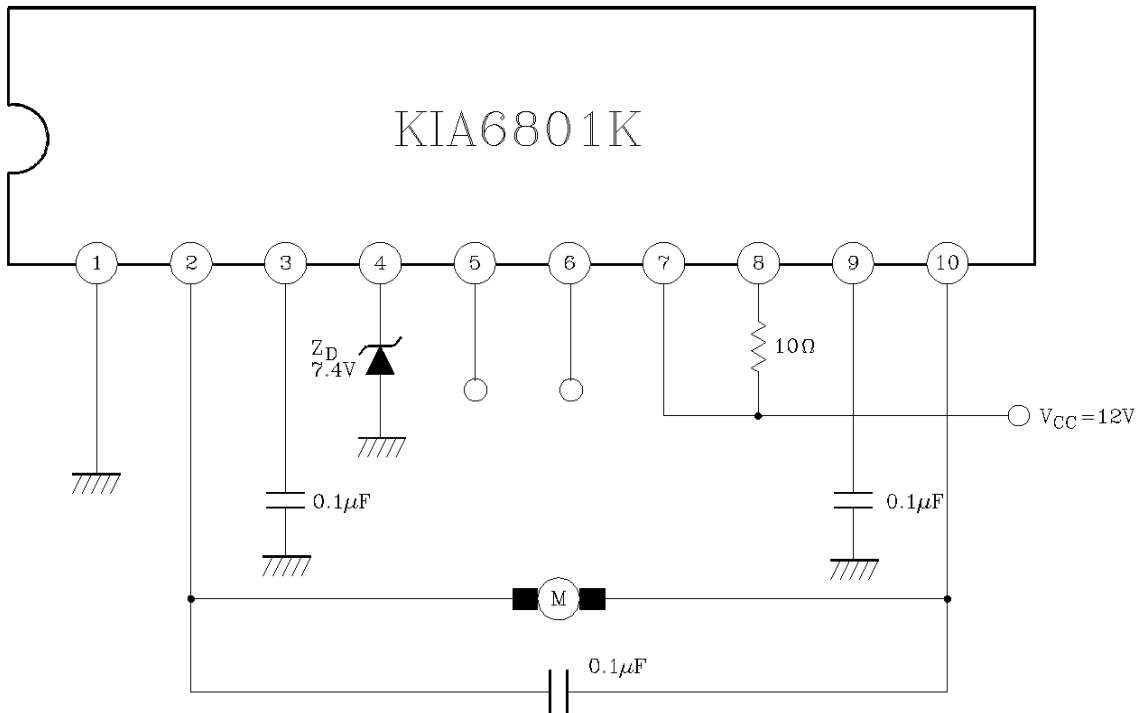

* Designed for a motor with ratings of 6V and 100mA

KIA6801K

APPLICATION INFORMATIONS

1. FORWARD AND REVERSE CONTROL LOGIC

Truth Table

Input		Output		Function
PIN 5	PIN 6	PIN 2	PIN 10	
L	L	L	L	Braking
L	H	L	H	Reverse
H	L	H	L	Forward
H	H	L	L	Braking

Note) Input Level : L : 0.7V or Less
H : 2.0V or more

- 1) If pin 5=H, pin 6=L, load current flows from pin 2 to pin 10 through a motor.
(refer to the truth table)
- 2) If pin 5=L, pin 6=H, load current flows from pin 10 to pin 2 through a motor.
(refer to the truth table)
- 3) If pin 5=pin 6=L or pin 5=pin 6=H, the KIA6801K stops supplying the power to motor while absorbing counter EMF from the motor as a brake.

2. RUSH CURRENT ABSORBING CIRCUIT

If a high voltage generated during reversing operation is applied across pin 2 and pin 10, an internal comparator activates the rush current absorbing circuit.

3. DRIVER CIRCUIT

In the forward mode, the drive stage supplies a load current to the motor from pin 2 to pin 10. In the reverse mode, it supplies the current from pin 10 to pin 2.

The output voltage (V_{out}) applied to the motor is given by the followings ;

$$V_{OUT} = V_{ZD} - V_{CE(sat)}, \text{ where } V_{ZD} : \text{ a zener voltage applied to pin 4.}$$

If pin 4 is left open, the output voltage is given by the followings ;

$$V_{OUT} = V_{CC1} - V_{CE(sat, pnp)} - 2V_F - V_{CE(sat)} \\ = V_{CC1} - 1.8 \text{ (} I_{OUT} = 100\text{mA)}$$

KIA6801K

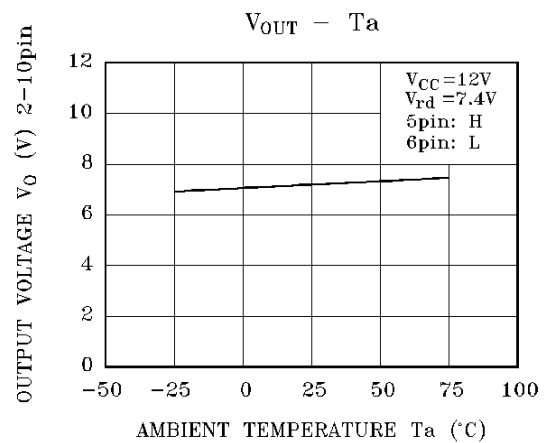
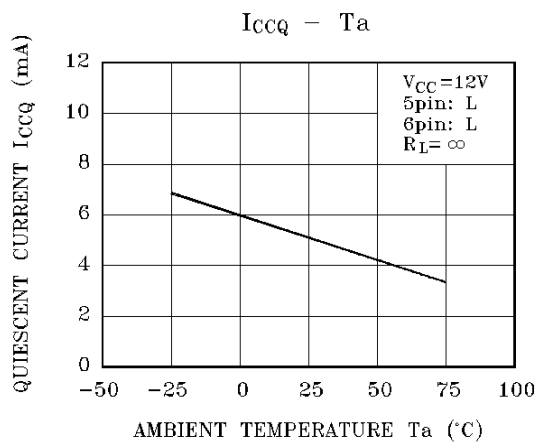
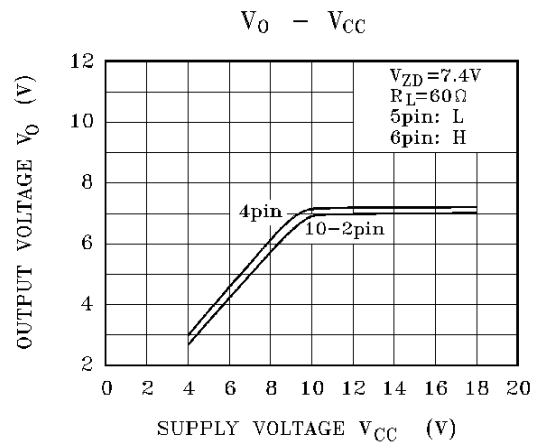
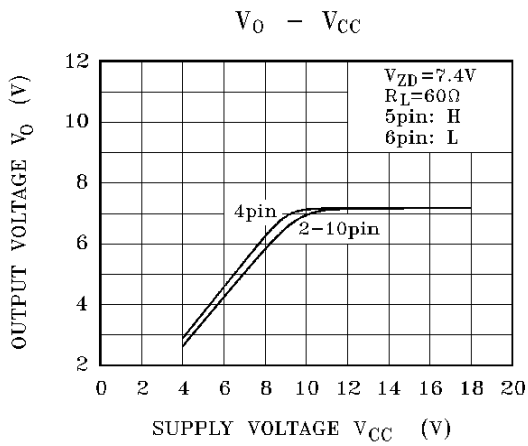
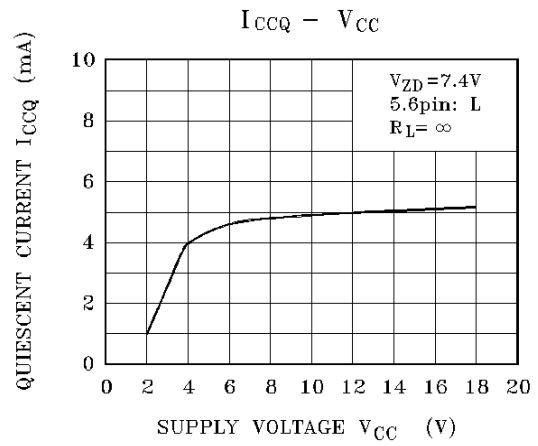
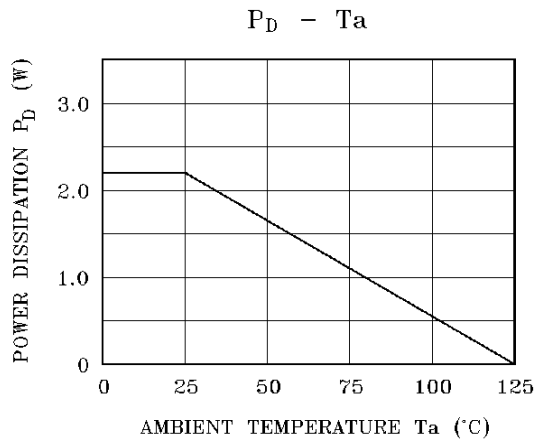

KIA6801K

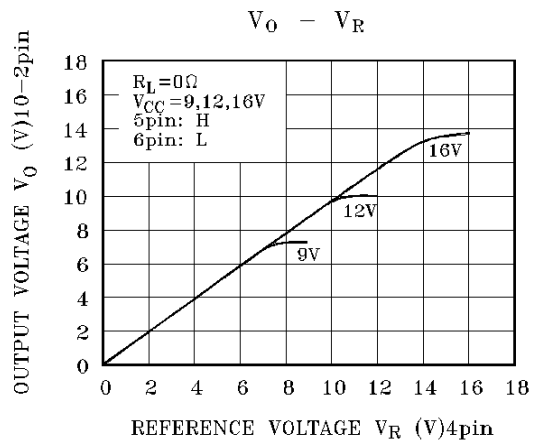
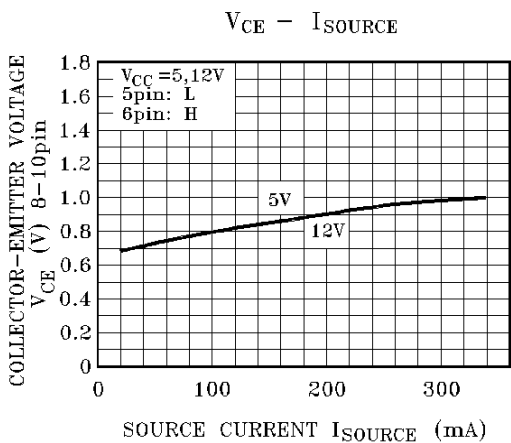
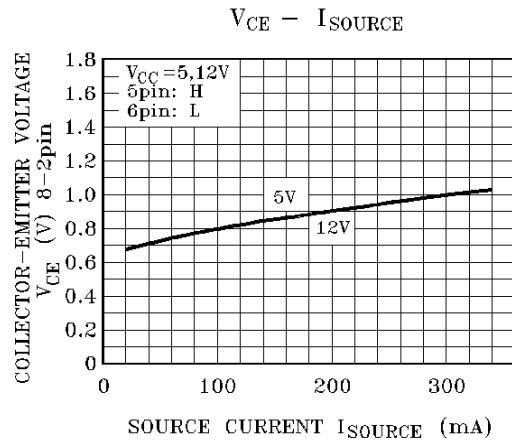
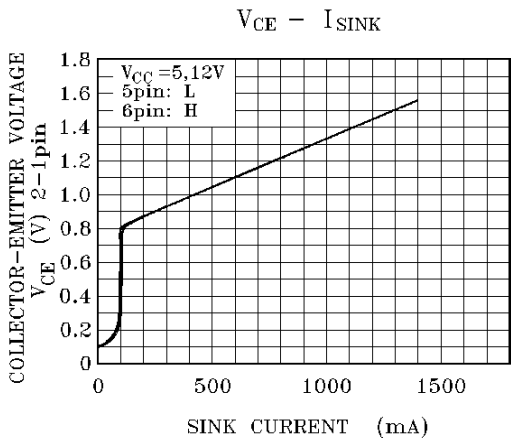
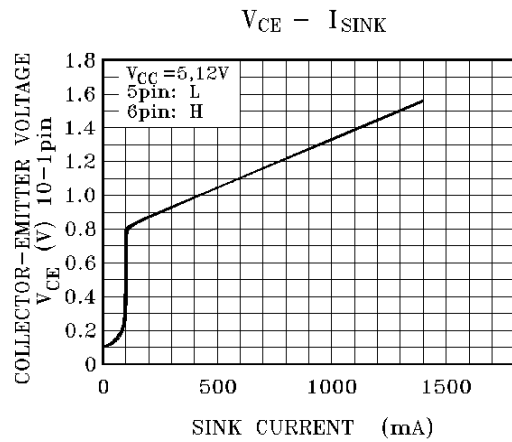
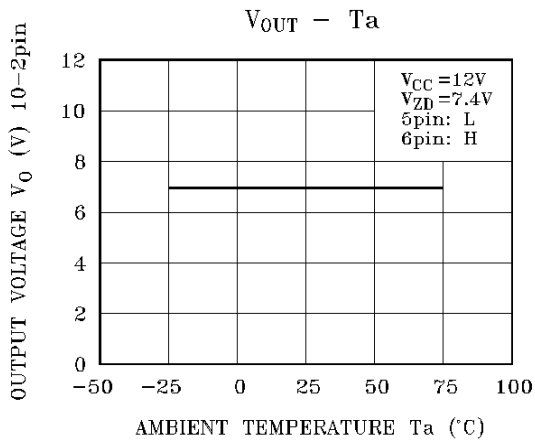

KIA6801K

