

3V AM/FM STEREO TUNER IC's

KIA8122AN/AF are the AM/FM 1chip tuner IC's, which are designed for portable radio and 3V headphone radios.

FEATURES

- Built-in FM F/E, AM/FM IF and FM MPX.
- AM detector coil, FM IFT and IF coupling condenser are not needed.
- For adopting ceramic discriminator and ceramic resonator, it is not necessary to adjust the FM quad detector circuit and MPX VCO circuit.
- S-curve characteristics of FM detection output is reverse characteristic.
- Operating supply voltage range.
: $V_{CC}=1.8\sim 7.0V$ ($T_a=25^\circ C$)

MAXIMUM RATINGS ($T_a=25^\circ C$)

CHARACTERISTIC	SYMBOL	RATING	UNIT
Supply Voltage	V_{CC}	8	V
LED Current	I_{LED}	10	mA
LED Voltage	I_{LED}	8	V
Power Dissipation	KIA8122AN	P_D (Note)	mW
	KIA8122AF		
Operating Temperature	T_{opr}	-25~75	$^\circ C$
Storage Temperature	T_{stg}	-55~150	$^\circ C$

Note : Derated above $T_a=25^\circ C$ in the proportion of 9.6mW/ $^\circ C$ for KIA8122AN and of 3.2mW/ $^\circ C$ for KIA8122AF

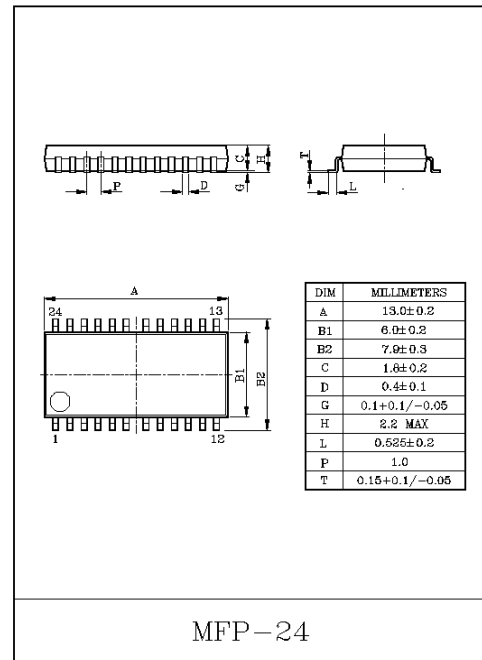
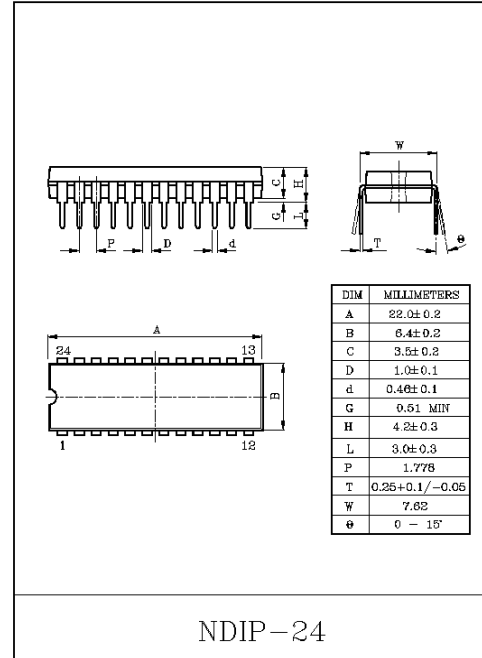

KIA8122AN/AF

ELECTRICAL CHARACTERISTICS

Unless otherwise specified, Ta=25°C, Vcc=3V, F/E: f=98MHz, fm=1kHz

FM IF: f=10.7MHz, Δf=±22.5kHz, fm=1kHz

AM: f=1MHz, Mod=30%, fm=1kHz, MPX: fm=1kHz

CHARACTERISTIC		SYMBOL	TEST CIRCUIT	TEST CONDITION	MIN.	TYP.	MAX.	UNIT
Supply Current		I _{CC(FM)}	1	V _{IN} =0, FM Mode	-	14.0	18.5	mA
		I _{CC(AM)}	1	V _{IN} =0, AM Mode	-	6.0	8.3	
F/E	Input Limiting Voltage	V _{IN(lim)}	1	-3dB Limiting	-	14.0	-	dBμ
	Local OSC Voltage	V _{OSC}	2	fosc=72.3MHz	70	105	140	mV _{rms}
FM IF	Input Limiting Voltage	V _{IN(lim)}	1	-3dB Limiting	39	44	49	dBμ
	Recovered Output Voltage	V _{OD}	1	V _{IN} =80dBμ	55	80	110	mV _{rms}
	Signal to Noise Ratio	S/N	1	V _{IN} =80dBμ	-	70	-	dB
	Total Harmonic Distortion	THD	1	V _{IN} =80dBμ	-	0.4	-	%
	AM Rejection Ratio	AMR	1	V _{IN} =80dBμ	-	50	-	dB
	Lamp ON Sensitivity	V _L	1	I _L =1mA	43	48	53	dBμ
AM	Gain	G _V	1	V _{IN} =26dBμ	20	40	80	mV _{rms}
	Recovered Output Voltage	V _{OD}	1	V _{IN} =60dBμ	50	60	100	mV _{rms}
	Signal to Noise Ratio	S/N	1	V _{IN} =60dBμ	-	44	-	dB
	Total Harmonic Distortion	THD	1	V _{IN} =60dBμ	-	1.0	-	%
	Lamp ON Sensitivity	V _L	1	I _L =1mA	19	24	29	dBμ
Pin 19 Output Resistance		R ₁₉	1	FM Mode	-	0.75	-	kΩ
				AM Mode	-	12.5	-	

KIA8122AN/AF

CHARACTERISTIC		SYMBOL	TEST CIRCUIT	TEST CONDITION	MIN.	TYP.	MAX.	UNIT		
MPX	Input Resistance	R_{IN}	1		-	24	-	$k\Omega$		
	Output Resistance	R_{OUT}	2		-	5	-	$k\Omega$		
	Max. Composite Signal Input Voltage	$V_{IN(MAX)}$ STEREO	1	L+R=90%, P=10% fm=1kHz, THD=3%	-	350	-	mV_{rms}		
	Separation		Sep	1	L+R= 135 mV_{rms} P=15 mV_{rms}	fm=100Hz	-	42	-	dB
						fm=1kHz	35	42	-	
						fm=10kHz	-	42	-	
	Total Harmonic Distortion	Monaural	THD (MONAURAL)	1	$V_{IN}=150mV_{rms}$	-	0.2	-	%	
		Stereo	THD (STEREO)		L+R=135 mV_{rms} , P=15 mV_{rms}	-	0.2	-		
	Voltage Gain		$G_V(MPX)$	1	$V_{IN}=150mV_{rms}$	-5	-3	-1	dB	
	Channel Balance		C.B.	1	$V_{IN}=150mV_{rms}$	-2	0	2	dB	
	Stereo Lamp Sensitivity	ON	$V_L(ON)$	1	Pilot Input	-	8	15	mV_{rms}	
		OFF	$V_L(OFF)$			2	6	-		
Stereo Lamp Hysteresis		V_H	1		-	2	-	mV_{rms}		
Capture Range		C.R.	1	P=15 mV_{rms}	-	1.3	-	%		
Signal to Noise Ratio		S/N	1		-	70	-	dB		

KIA8122AN/AF

EXPLANATION OF TERMINALS

Pin NO.	ITEM	INTERNAL CIRCUIT	DC VOLTAGE(V) (at no signal)	
			AM	FM
1	FM-RF IN		0	0.7
2	GND1 (GND for Rf Stage)		0	0
3	FM MIX		2.3	1.8
4	AM MIX		2.3	1.8
5	AGC (AM AGC)		0	0
6	Vcc2 (Vcc for IF/MPX Stage)		3.0	3.0

KIA8122AN/AF

Pin NO.	ITEM	INTERNAL CIRCUIT	DC VOLTAGE(V) (at no signal)	
			AM	FM
7	AM IF IN		3.0	3.0
8	FM IF IN		3.0	3.0
9	GND2 (GND for IF/MPX Stage)		0	0
10	TUN LED (Tuning LED)		-	-
11	ST LED (Stereo LED)		-	-
12	QUAD (FM QUAD, Detector)		2.4	2.1

KIA8122AN/AF

Pin NO.	ITEM	INTERNAL CIRCUIT	DC VOLTAGE(V) (at no signal)	
			AM	FM
13 14	R-OUT(R-ch Output) L-OUT(L-ch Output)		1.0	1.0
15	VCO		2.5	2.5 (VCO STOP MODE)
16	LPF2 ·LPF Terminal for Synchronous Detector ·Bias Terminal for AM/AM SW Circuit $V_{16}=V_{CC} \rightarrow$ AM $V_{16}=\text{Open} \rightarrow$ FM		3.0	2.2 (VCO STOP MODE 2.7)
17	LPF1 ·LPF Terminal for Phase Detector Vco Stop Terminal $V_{17}=V_{CC} \rightarrow$ VCO Stop		2.7	2.2
18	MPX IN		0.7	0.7

KIA8122AN/AF

Pin NO.	ITEM	INTERNAL CIRCUIT	DC VOLTAGE(V) (at no signal)	
			AM	FM
19	DET OUT		1.5	1.2
20	AM OSC		3.0	3.0
21	FM OSC		3.0	3.0
22	Vcc1 (Vcc for RF Stage)		3.0	3.0
23	FM RF OUT		3.0	3.0
24	AM RF IN		3.0	3.0

KIA8122AN/AF

TEST CIRCUIT 2

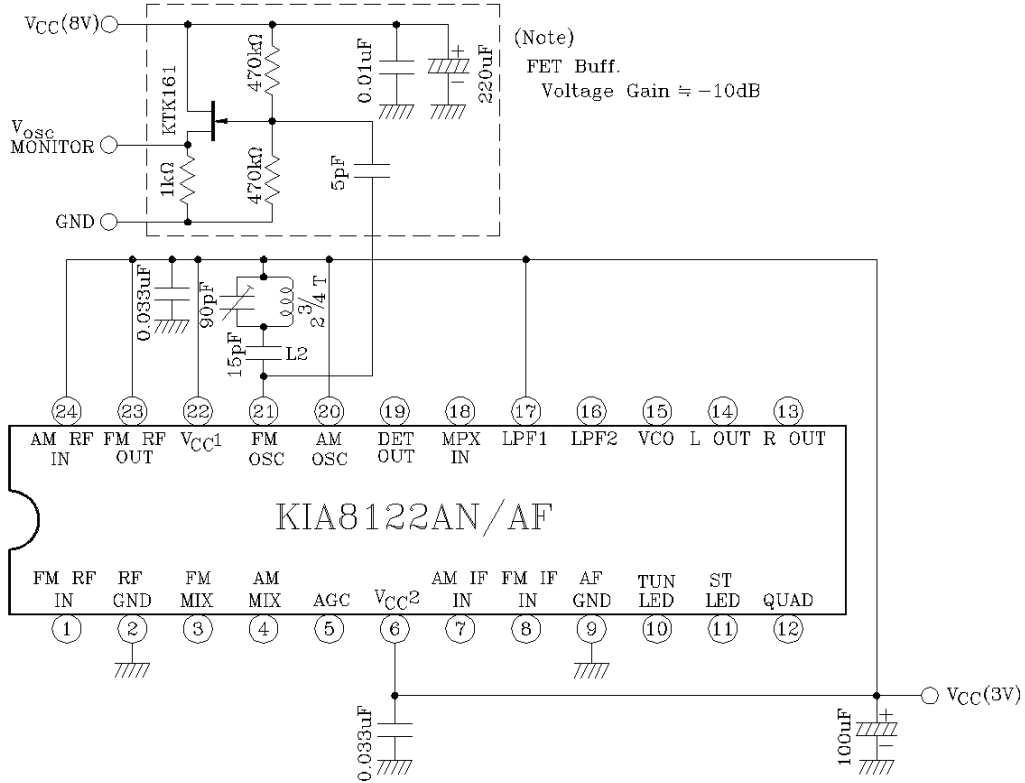

COIL DATA

COIL NO.	TEST FREQ.	L (μ H)	Co (pF)	Q _o	TURNS					WIRE (mm ϕ)	REFERENCE
					1-2	2-3	1-3	1-4	4-6		
L ₁ FM RF	100MHz			100				2 1/2		0.5 UEW	
L ₂ FM OSC	100MHz			100			2 3/4			0.5 UEW	
T ₁ AM OSC	796kHz	288		115	13	73				0.08 UEW	Ⓔ 4147-1356-038 Ⓕ KSA0406
T ₂ AM IFT	455kHz		180	120			180		15	0.08 UEW	Ⓔ 2150-2162-165 Ⓕ KSAM307

Ⓔ : SUMIDA ELECTRIC CO., LTD.
Ⓕ : KWANG SUNG ELECTRONICS CO., LTD (Tel : 02)716-0034)

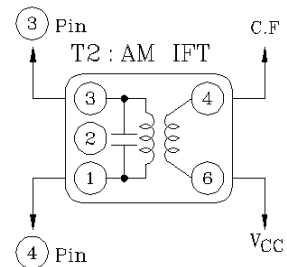
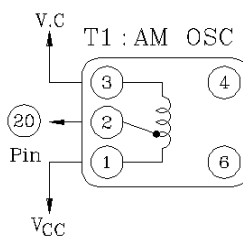
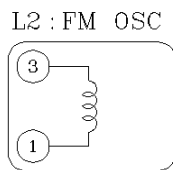
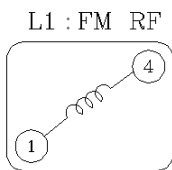

KIA8122AN/AF

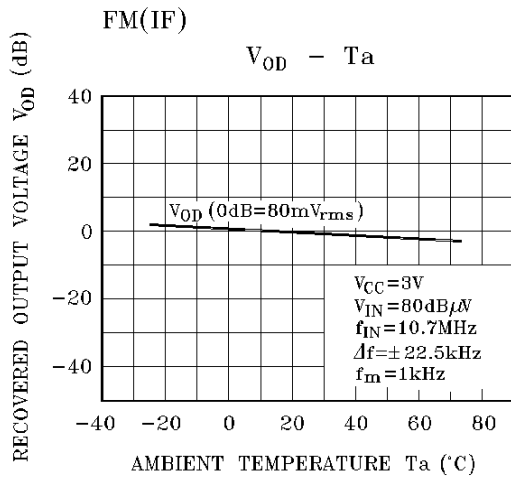
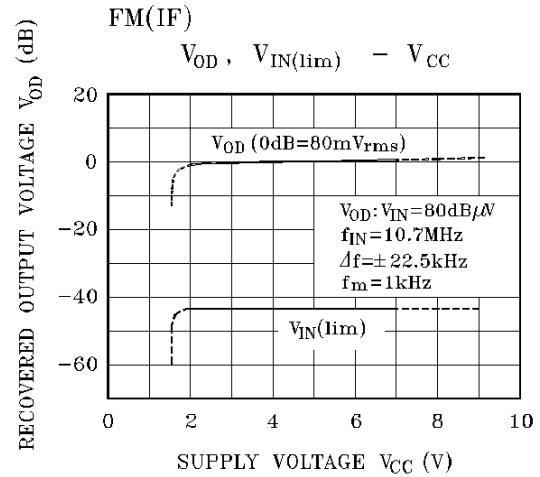
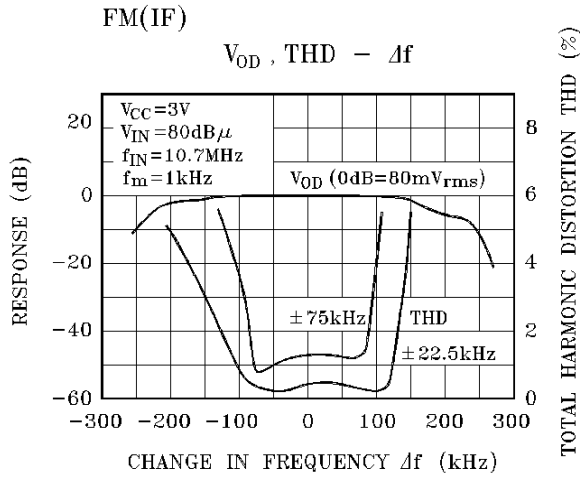
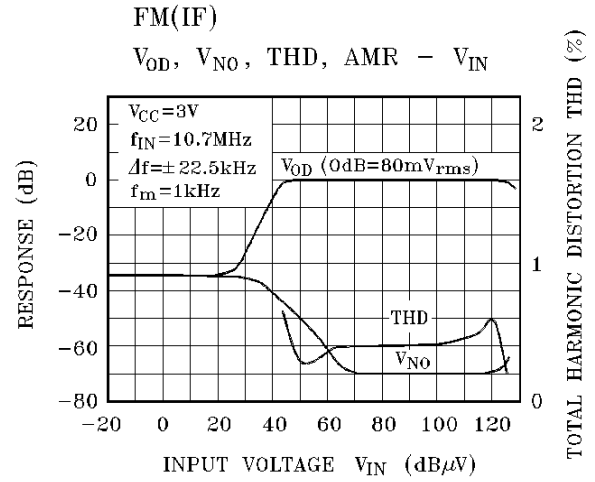
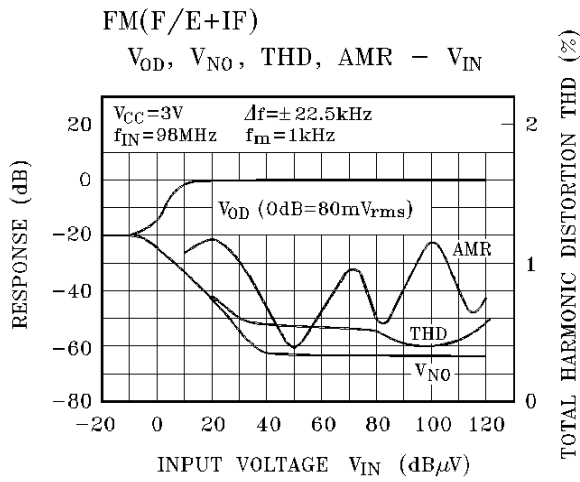

KIA8122AN/AF

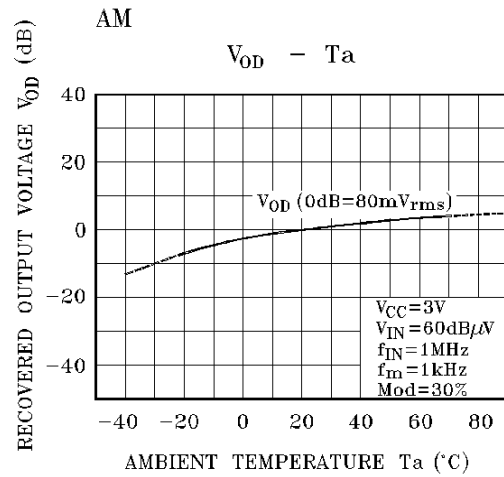
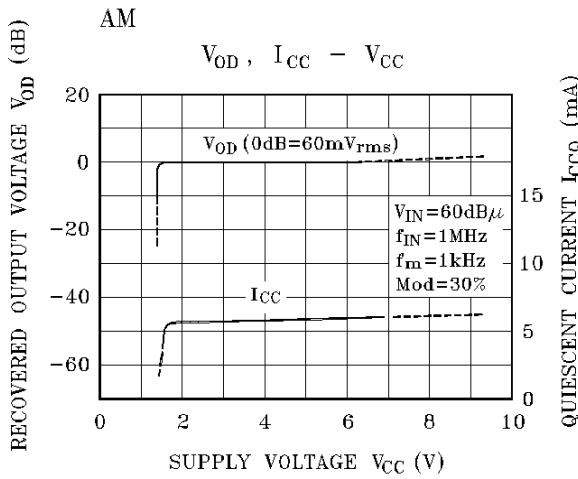
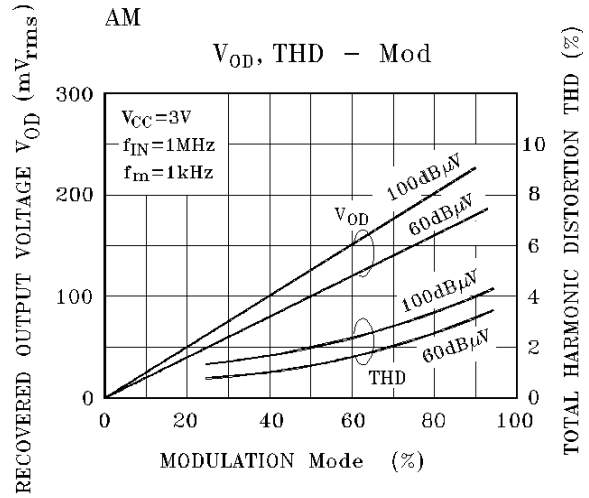
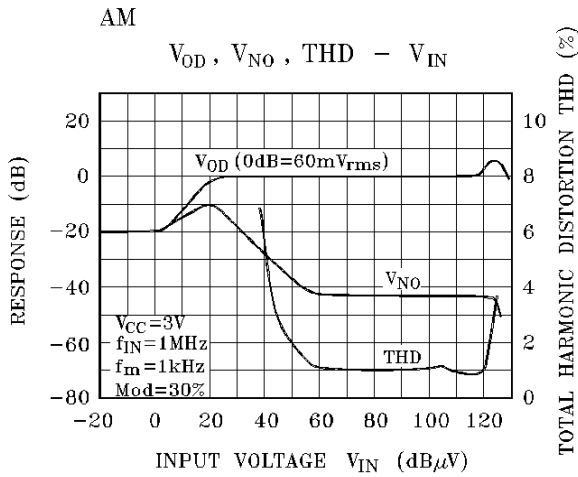

KIA8122AN/AF

