

SWITCHING APPLICATION.  
INTERFACE CIRCUIT AND DRIVER CIRCUIT APPLICATION.

#### FEATURES

- With Built-in Bias Resistors.
- Simplify Circuit Design.
- Reduce a Quantity of Parts and Manufacturing Process.

#### EQUIVALENT CIRCUIT

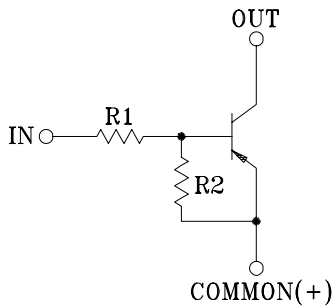

#### BIAS RESISTOR VALUES

TYPE NO.	R1(k $\Omega$ )	R2(k $\Omega$ )
KRA101M	4.7	4.7
KRA102M	10	10
KRA103M	22	22
KRA104M	47	47
KRA105M	2.2	47
KRA106M	4.7	47

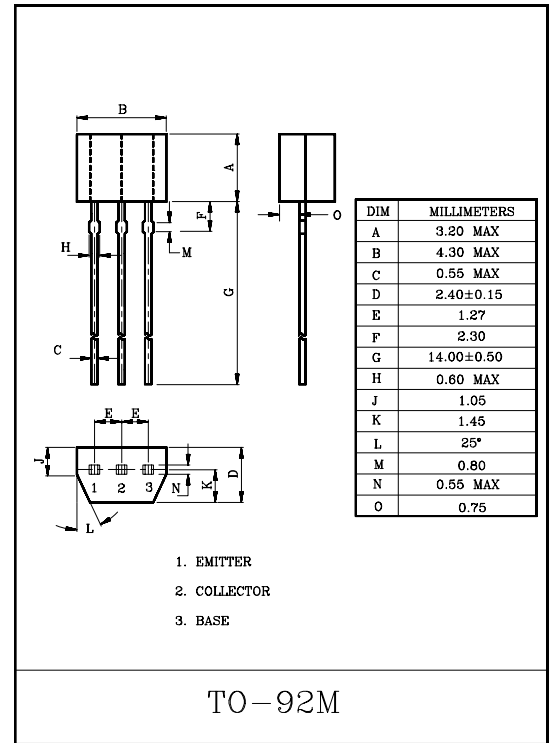

#### MAXIMUM RATINGS (Ta=25°C)

CHARACTERISTIC		SYMBOL	RATING	UNIT
Output Voltage	KRA101M ~106M	V <sub>O</sub>	-50	V
Input Voltage	KRA101M	V <sub>I</sub>	-20, 10	V
	KRA102M		-30, 10	
	KRA103M		-40, 10	
	KRA104M		-40, 10	
	KRA105M		-12, 5	
	KRA106M		-20, 5	
Output Current	KRA101M ~106M	I <sub>O</sub>	-100	mA
Power Dissipation		P <sub>D</sub>	400	mW
Junction Temperature		T <sub>j</sub>	150	°C
Storage Temperature Range		T <sub>stg</sub>	-55~150	°C

# KRA101M~KRA106M

## ELECTRICAL CHARACTERISTICS (Ta=25°C)

CHARACTERISTIC		SYMBOL	TEST CONDITION	MIN.	TYP.	MAX.	UNIT
Output Cut-off Current	KRA101M~106M	$I_{O(OFF)}$	$V_O=-50V, V_I=0$	-	-	-500	nA
DC Current Gain	KRA101M	$G_I$	$V_O=-5V, I_O=-10mA$	30	55	-	
	KRA102M			50	80	-	
	KRA103M			70	120	-	
	KRA104M			80	200	-	
	KRA105M			80	200	-	
	KRA106M			80	200	-	
Output Voltage	KRA101M~106M	$V_{O(ON)}$	$I_O=-10mA, I_I=-0.5mA$	-	-0.1	-0.3	V
Input Voltage (ON)	KRA101M	$V_{I(ON)}$	$V_O=-0.2V, I_O=-5mA$	-	-1.5	-2.0	V
	KRA102M			-	-1.8	-2.4	
	KRA103M			-	-2.1	-3.0	
	KRA104M			-	-2.8	-5.0	
	KRA105M			-	-0.8	-1.1	
	KRA106M			-	-0.9	-1.3	
Input Voltage (OFF)	KRA101M~104M	$V_{I(OFF)}$	$V_O=-5V, I_O=-0.1mA$	-1.0	-1.2	-	V
	KRA105M~106M			-0.5	-0.65	-	
Transition Frequency	KRA101M~106M	$f_T$ *	$V_O=-10V, I_O=-5mA$	-	200	-	MHz
Input Current	KRA101M	$I_I$	$V_I=-5V$	-	-	-1.8	mA
	KRA102M			-	-	-0.88	
	KRA103M			-	-	-0.36	
	KRA104M			-	-	-0.18	
	KRA105M			-	-	-3.6	
	KRA106M			-	-	-1.8	

Note : \*Characteristic of Transistor Only

# KRA101M~KRA106M

ELECTRICAL CHARACTERISTICS (Ta=25°C)

CHARACTERISTIC		SYMBOL	TEST CONDITION	MIN.	TYP.	MAX.	UNIT	
Switching Time	Rise Time	KRA101M	$V_O=-5V$ $V_{IN}=-5V$ $R_L=1k\Omega$	-	0.07	-	$\mu S$	
		KRA102M		-	0.06	-		
		KRA103M		-	0.2	-		
		KRA104M		-	0.24	-		
		KRA105M		-	0.02	-		
		KRA106M		-	0.07	-		
	Storage Time	KRA101M		$t_{stg}$	-	1.1		-
		KRA102M		-	-	1.1		-
		KRA103M		-	-	1.1		-
		KRA104M		-	-	1.1		-
		KRA105M		-	-	1.1		-
		KRA106M		-	-	1.1		-
	Fall Time	KRA101M		$t_f$	-	0.15		-
		KRA102M		-	-	0.24		-
		KRA103M		-	-	0.38		-
		KRA104M		-	-	0.63		-
		KRA105M		-	-	0.1		-
		KRA106M		-	-	0.2		-

# KRA101M~KRA106M

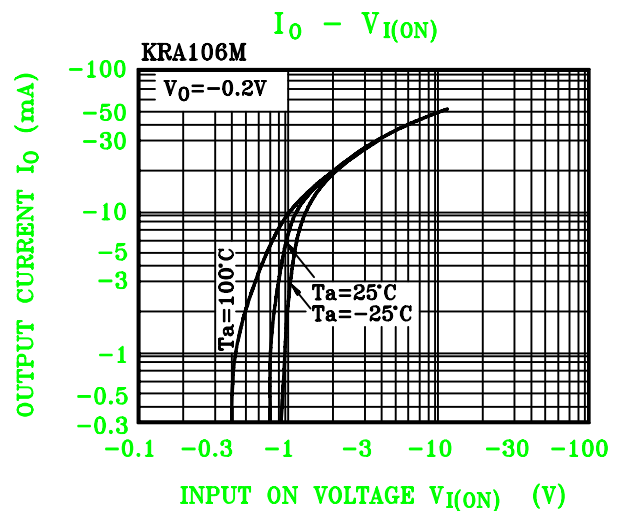
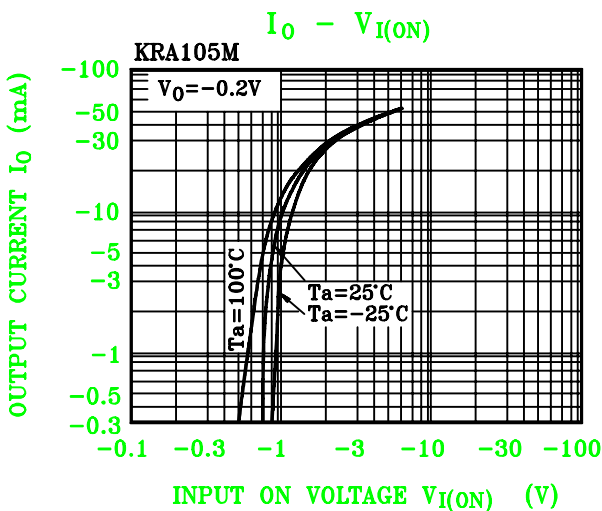
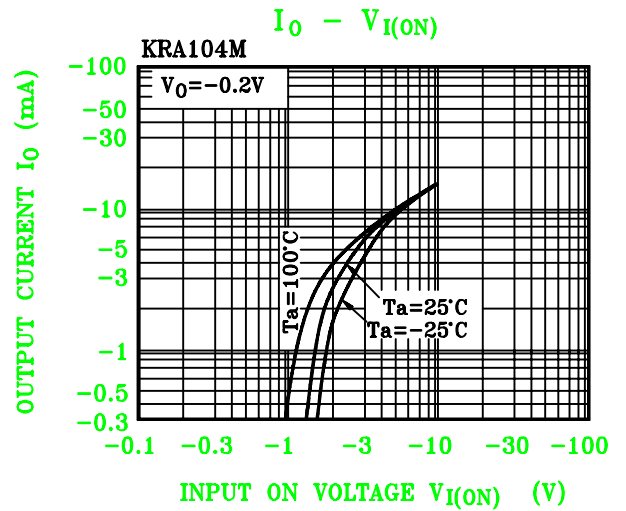
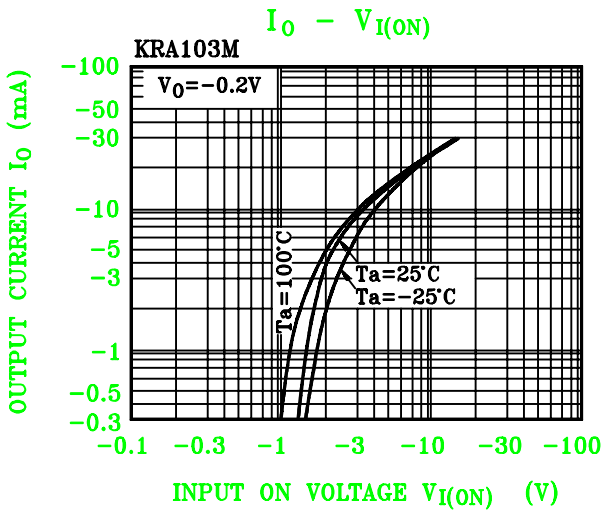
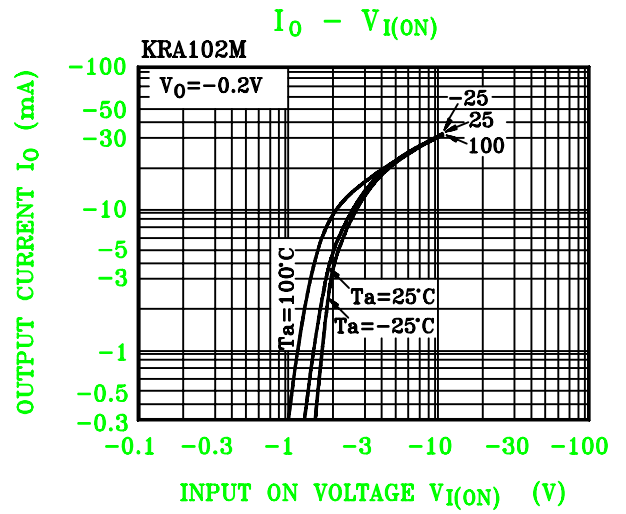
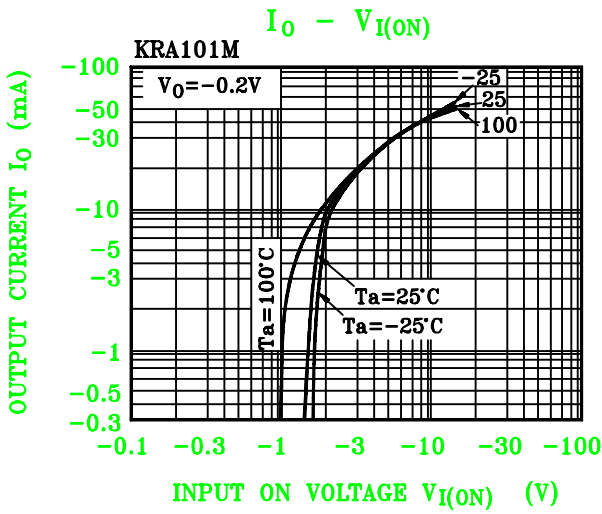

# KRA101M~KRA106M

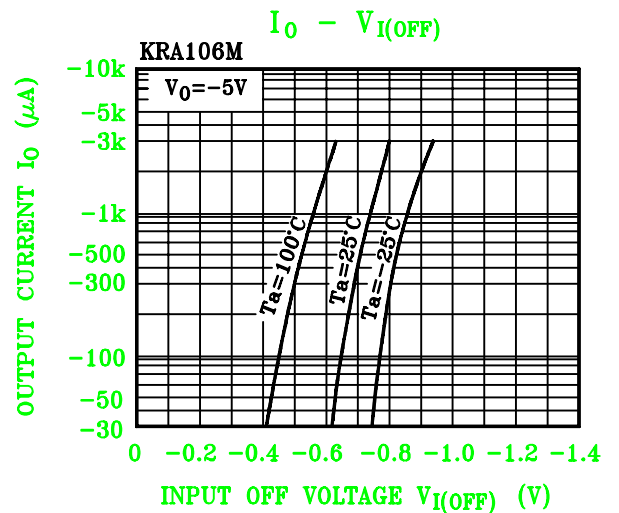
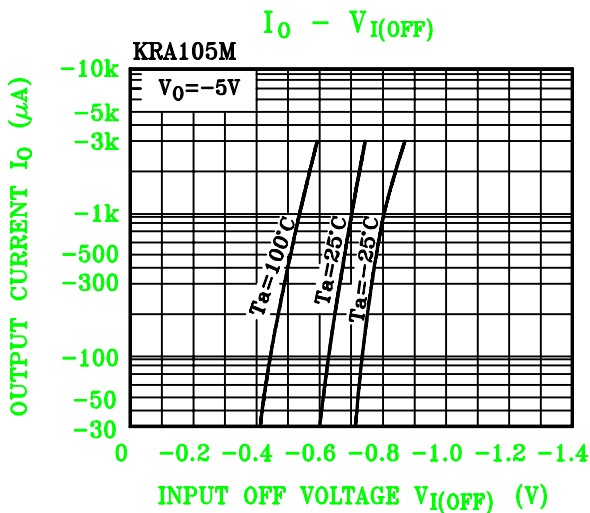
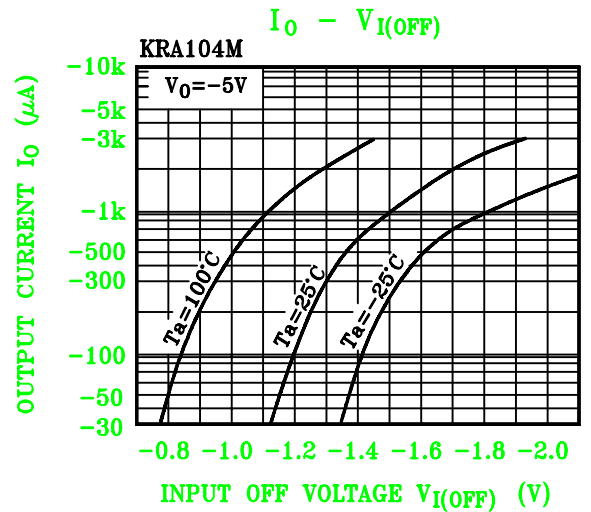
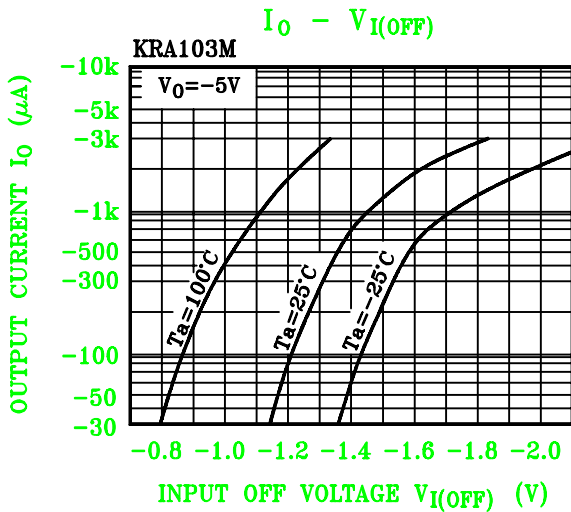
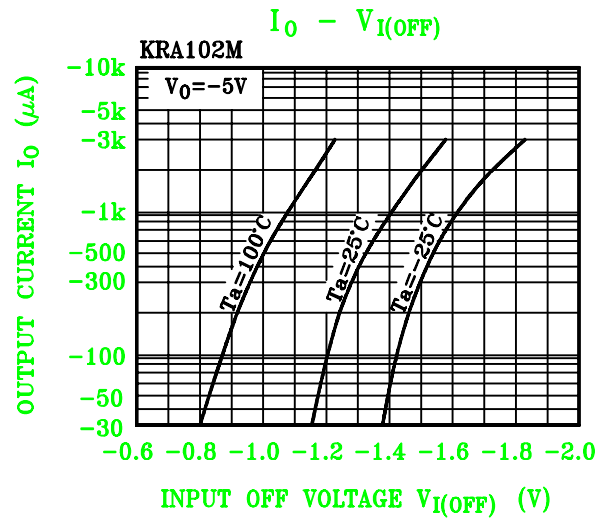
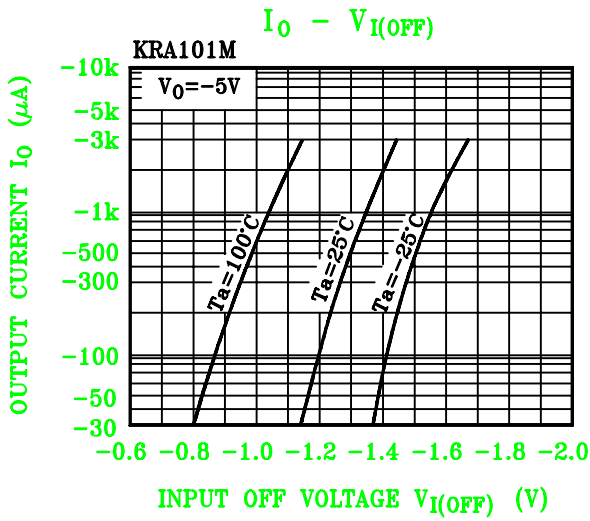

# KRA101M ~ KRA106M

