

HIGH CURRENT SWITCHING APPLICATION.
INTERFACE CIRCUIT AND DRIVER CIRCUIT APPLICATION.

FEATURES

- With Built-in Bias Resistors.
- Simplify Circuit Design.
- Reduce a Quantity of Parts and Manufacturing Process.
- High Output Current :-800mA.

EQUIVALENT CIRCUIT

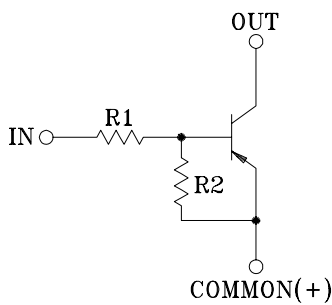

TYPE NO.	R1(k Ω)	R2(k Ω)
KRA221M	1	1
KRA222M	2.2	2.2
KRA223M	4.7	4.7
KRA224M	10	10
KRA225M	1	10
KRA226M	2.2	10

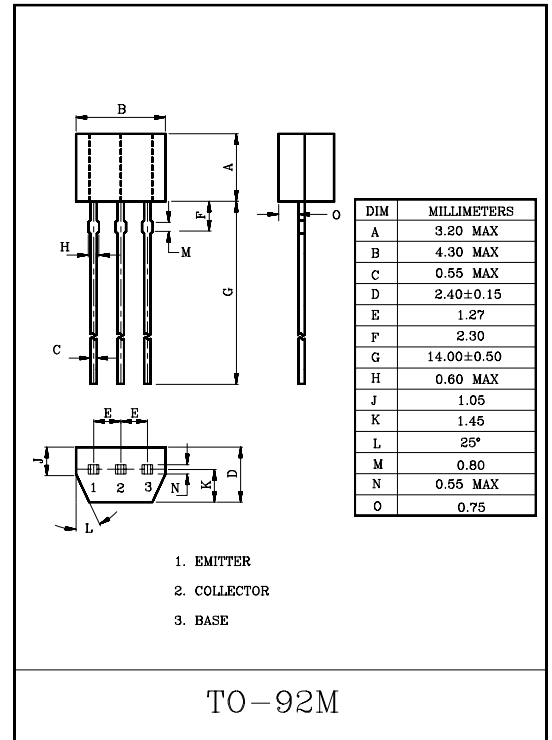

MAXIMUM RATINGS(Ta=25°C)

CHARACTERISTIC		SYMBOL	RATING	UNIT
Output Voltage	KRA221M ~ 226M	V _o	-50	V
Input Voltage	KRA221M	V _i	-10, 10	V
	KRA222M		-12, 10	
	KRA223M		-20, 10	
	KRA224M		-30, 10	
	KRA225M		-10, 5	
	KRA226M		-12, 6	
Output Current	KRA221M ~ 226M	I _o	-800	mA
Power Dissipation		P _D	400	mW
Junction Temperature		T _j	150	°C
Storage Temperature Range		T _{stg}	-55~150	°C

KRA221M ~ KRA226M

ELECTRICAL CHARACTERISTICS (Ta=25°C)

CHARACTERISTIC		SYMBOL	TEST CONDITION	MIN.	TYP.	MAX.	UNIT
Output Cut-off Current	KRA221M~226M	$I_{O(OFF)}$	$V_O=-30V, V_I=0$	-	-	-10	μA
DC Current Gain	KRA221M	G_I	$V_O=-5V, I_O=-50mA$	33	-	-	
	KRA222M			39	-	-	
	KRA223M			47	-	-	
	KRA224M			56	-	-	
	KRA225M			56	-	-	
	KRA226M			56	-	-	
Output Voltage	KRA221M~226M	$V_{O(ON)}$	$I_O=-50mA, I_I=-2.5mA$	-	-0.1	-0.3	V
Input Voltage (ON)	KRA221M	$V_{I(ON)}$	$V_O=-0.3V, I_O=-20mA$	-	-	-3.0	V
	KRA222M			-	-	-3.0	
	KRA223M			-	-	-3.0	
	KRA224M			-	-	-3.0	
	KRA225M			-	-	-3.0	
	KRA226M			-	-	-2.0	
Input Voltage (OFF)	KRA221M~224M	$V_{I(OFF)}$	$V_O=-5V, I_O=-0.1mA$	-0.5	-	-	V
	KRA225M~226M			-0.3	-	-	
Transition Frequency	KRA221M~226M	f_T^*	$V_O=-10V, I_O=-5mA, f=100MHz$	-	200	-	MHz
Input Current	KRA221M	I_I	$V_I=-5V$	-	-	-7.2	mA
	KRA222M			-	-	-7.2	
	KRA223M			-	-	-1.8	
	KRA224M			-	-	-0.88	
	KRA225M			-	-	-7.2	
	KRA226M			-	-	-3.6	

Note : *Characteristic of Transistor Only

KRA221M ~ KRA226M

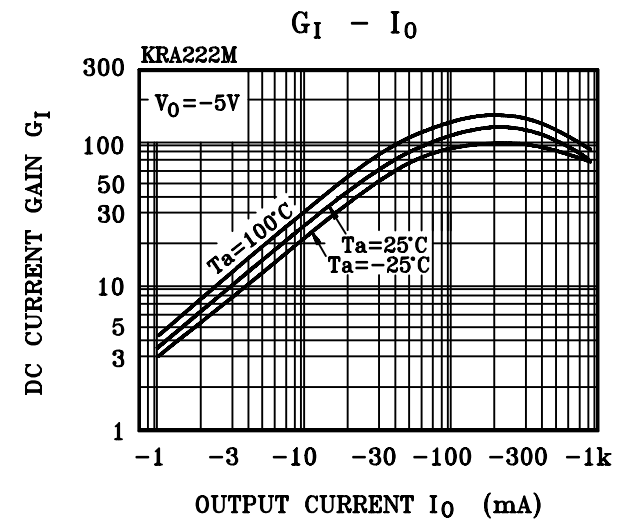
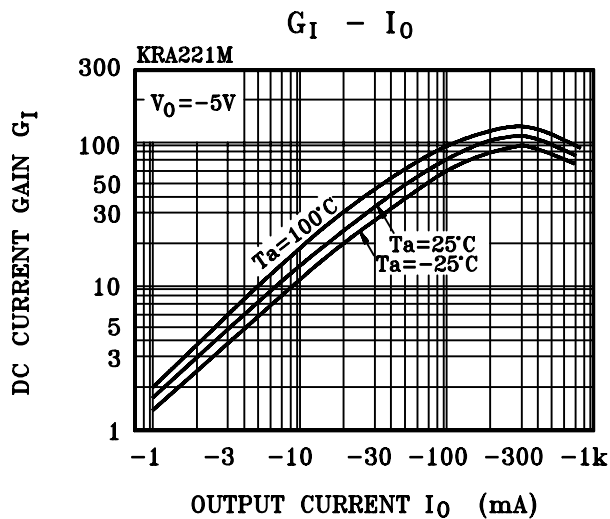
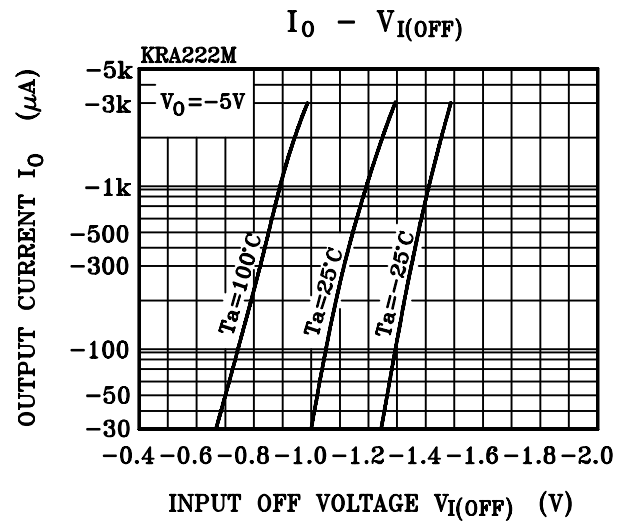
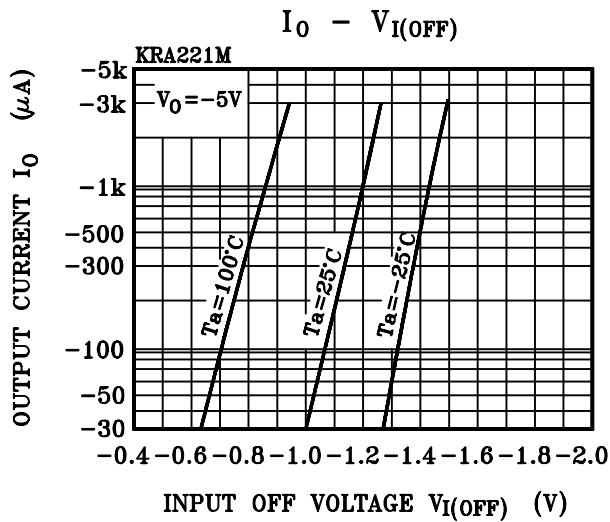
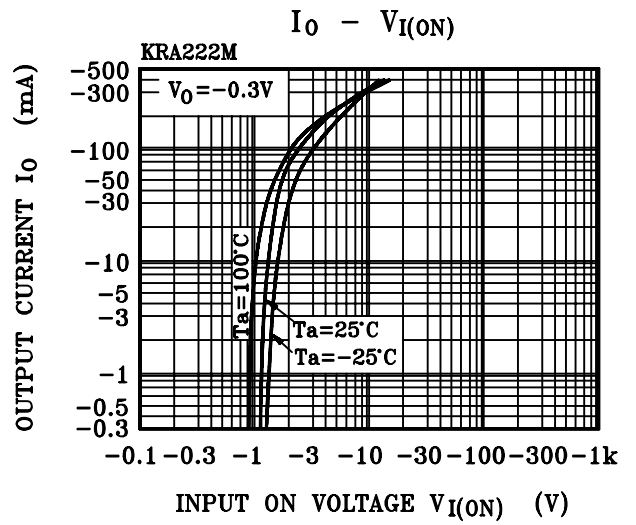
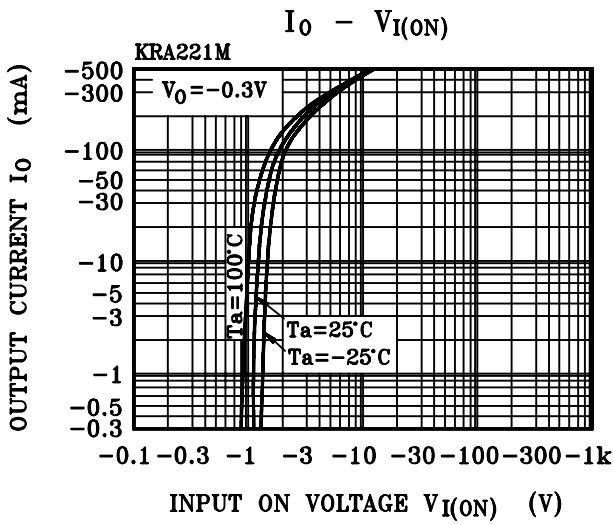

KRA221M ~ KRA226M

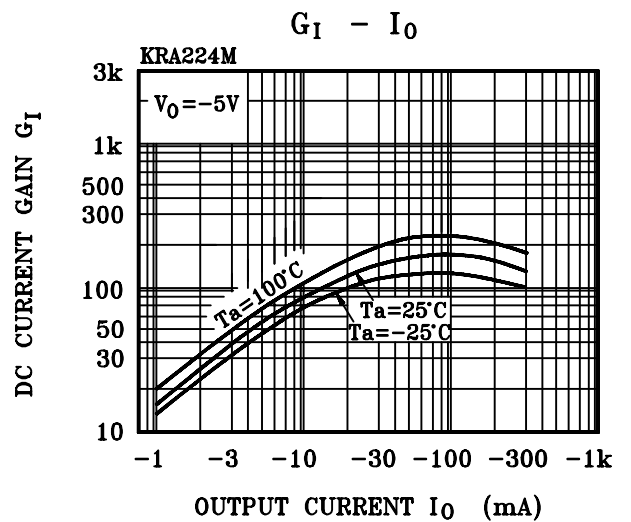
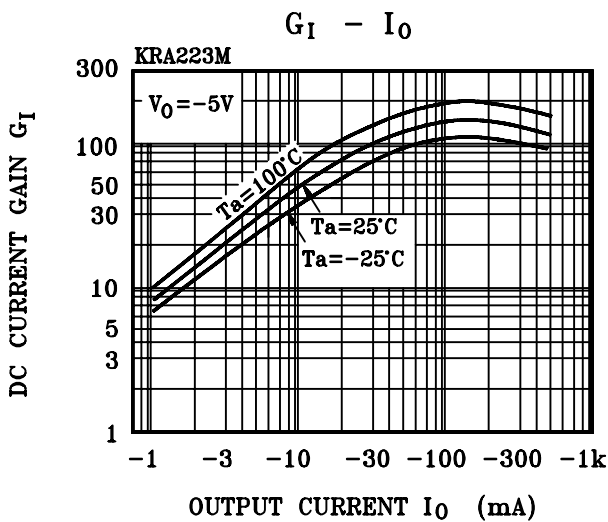
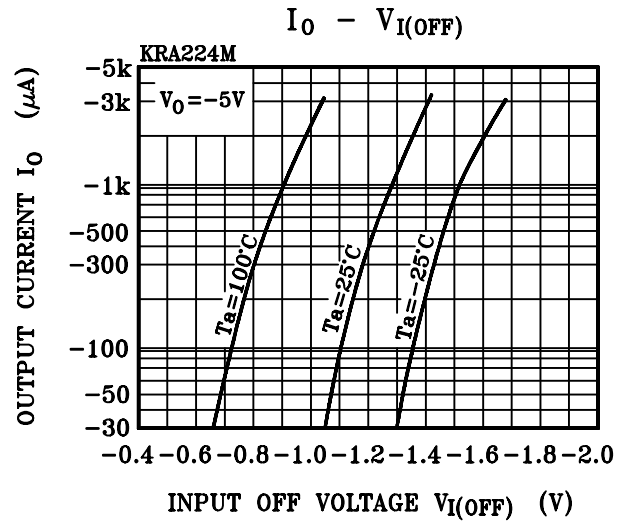
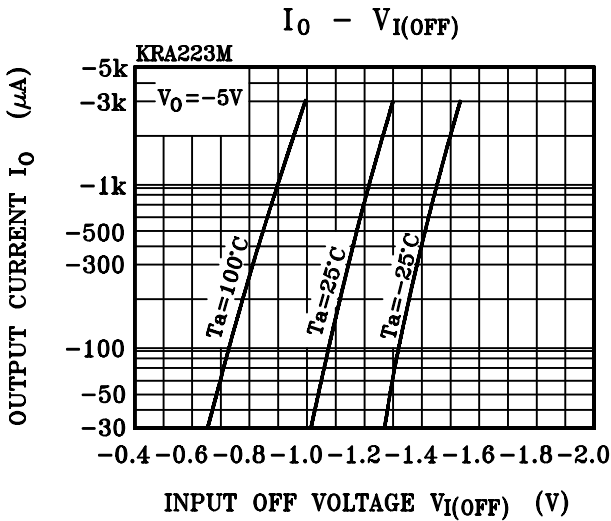
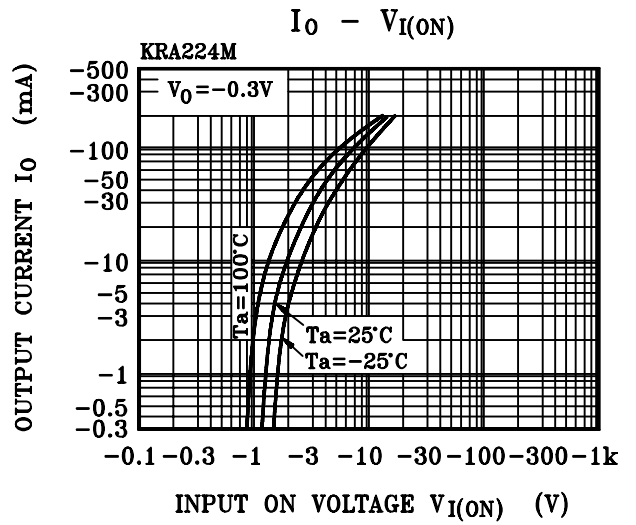
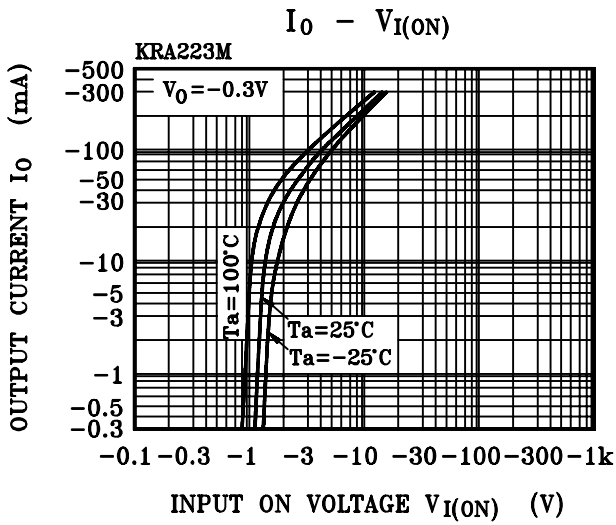

KRA221M ~ KRA226M

