

CB TRANSCEIVER TX FINAL AMPLIFIER APPLICATION.
HF TRANSCEIVER APPLICATION.

FEATURES

- Recommended for Output Stage Application of AM 4W Transmitter.
- High Power Gain.
- Wide Area of Safe Operation.

MAXIMUM RATINGS(Ta=25°C)

CHARACTERISTIC	SYMBOL	RATING	UNIT
Collector-Base Voltage	V _{CBO}	80	V
Collector-Emitter Voltage (R _{BE} =50Ω)	V _{CER}	80	V
Emitter-Base Voltage	V _{EBO}	4	V
Collector Current	I _C	4	A
Emitter Current	I _E	-4	A
Collector Power Dissipation (T _c =25°C)	P _C	10	W
Junction Temperature	T _j	150	°C
Storage Temperature Range	T _{stg}	-55~150	°C

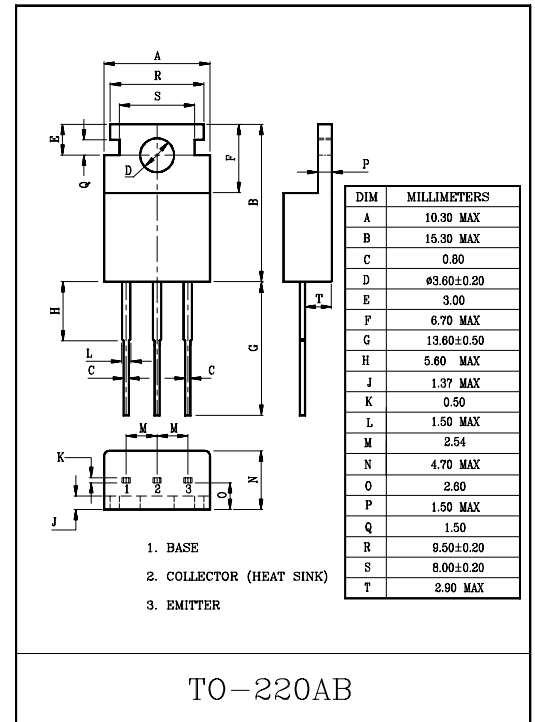

ELECTRICAL CHARACTERISTICS (Ta=25°C)

CHARACTERISTIC	SYMBOL	TEST CONDITION	MIN.	TYP.	MAX.	UNIT	
Collector Cut-off Current	I _{CBO}	V _{CB} =30V, I _E =0	-	-	10	μA	
Breakdown Voltage	Collector-Emitter	V _{(BR)CER}	I _C =10mA, R _{BE} =50Ω	80	-	-	V
	Emitter-Base	V _{(BR)EBO}	I _E =1.0mA, I _C =0	4	-	-	V
DC Current Gain	h _{FE}	V _{CE} =5V, I _C =0.5A	100	-	200		
Collector-Emitter Saturation Voltage	V _{CE(sat)}	I _C =3A, I _B =0.3A	-	-	1.5	V	
Transition Frequency	f _T	V _{CE} =5V, I _C =500mA	100	-	-	MHz	
Collector Output Capacitance	C _{ob}	V _{CB} =10V, I _E =0, f=1MHz	-	40	-	pF	
Output Power (Fig.1)	P _o	V _{CC} =12V, P _i =0.3W, f=27MHz	4	-	-	W	

Fig.1o P TEST CIRCUIT

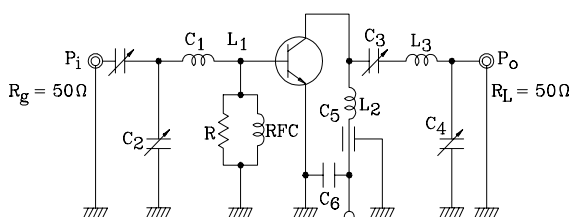

C₁:~100pF, C₂,C₃:~150pF, C₄:~300pF, C₅:1000pF

C₆:0.01μF, R:250Ω

L₁:0.8mm φ UEW,7T,8mm I.D L₂:0.8mm φ UEW,5T,8mm I.D

L₃:0.8mm φ UEW,10T,8mm I.D RFC:0.35mm φ UEW,17T,5mm I.D

Fig.2 27MHz 4W OUTPUT AM TRANSCEIVER CIRCUIT

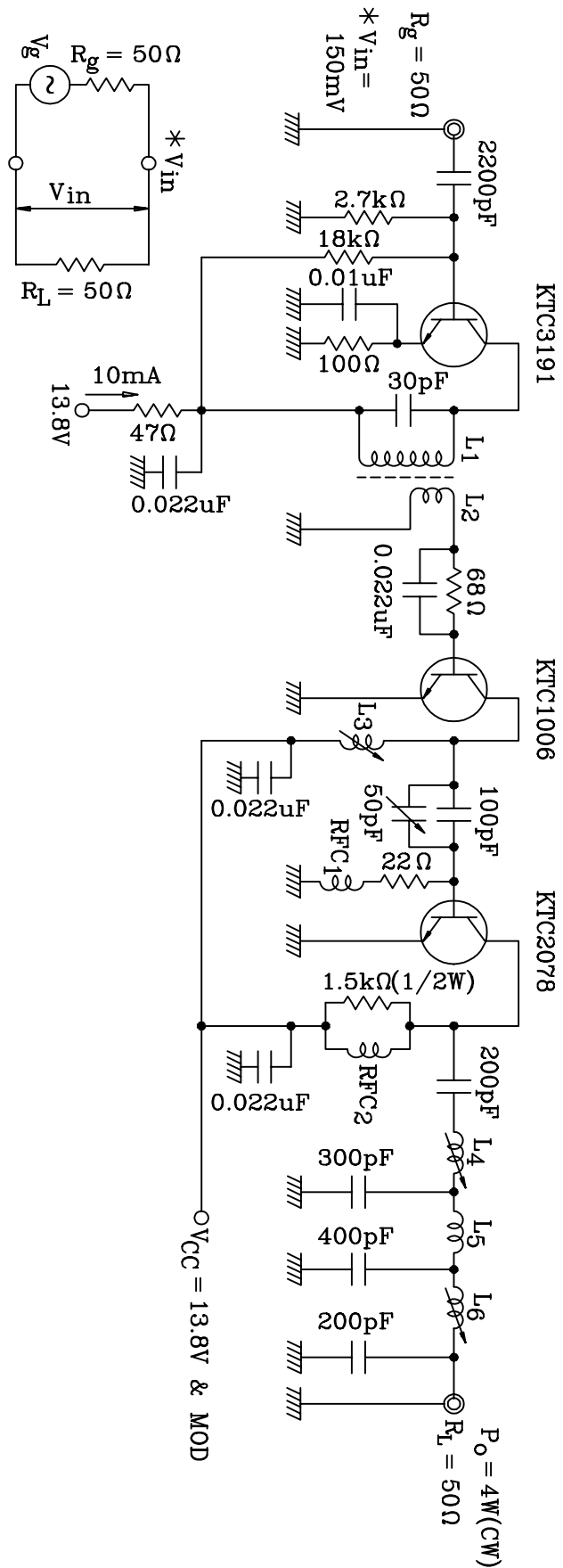

- L1 : 4mm ϕ BOBBIN WITH FERRITE CORE, 0.08mm ϕ UEW, 8 TURNS
 - L2 : 4mm ϕ BOBBIN WITH FERRITE CORE, 0.08mm ϕ UEW, 2 TURNS
 - L3, L6 : 6.5mm ϕ BOBBIN WITH FERRITE CORE, 0.6mm ϕ Sn PLATED COPPER WIRE 6 $\frac{1}{2}$ TURNS
 - L4 : 6.5mm ϕ BOBBIN WITH FERRITE CORE, 0.6mm ϕ Sn PLATED COPPER WIRE 8 $\frac{1}{2}$ TURNS
 - L5 : 0.6mm ϕ Sn PLATED COPPER WIRE, 6.5mm I.D, 8 $\frac{1}{2}$ TURNS
 - RFC1 : 4.7 μ H, 7BA-480k (TOKO)
 - RFC2 : 0.2mm ϕ UEW, 30 TURNS
- RESISTOR : 1/4W CARBON
CAPACITOR : CERAMIC

$P_0 - P_i$

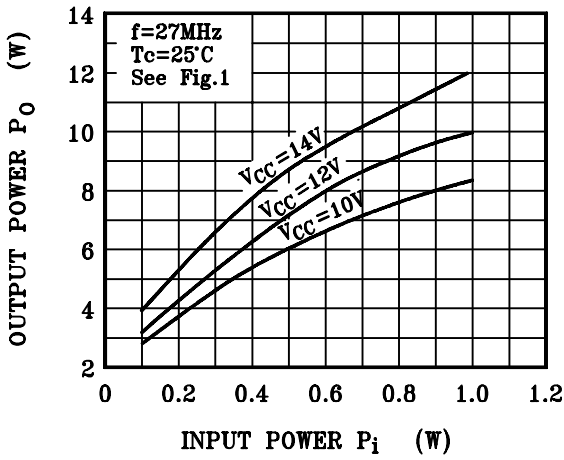

$P_0 - V_{CC}$

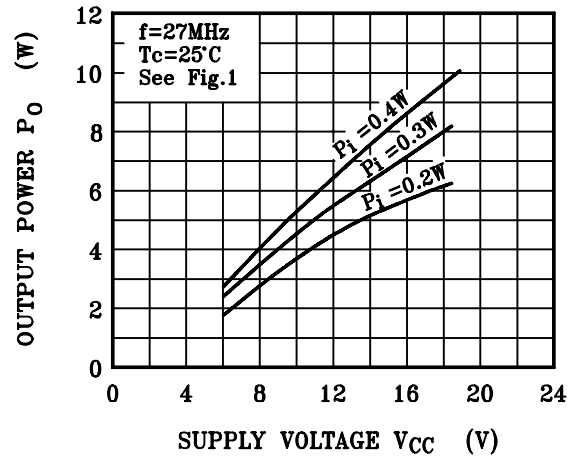

$h_{FE} - I_c$

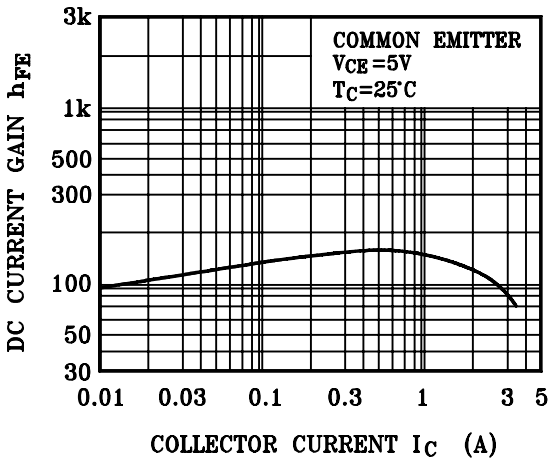

$f_T - I_c$

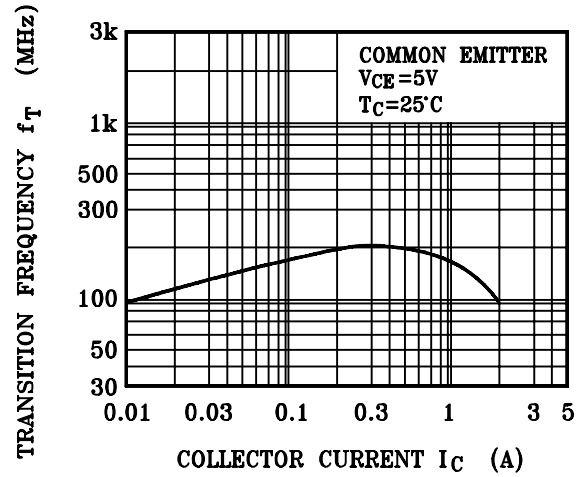

$C_{ob} - V_{CB}$

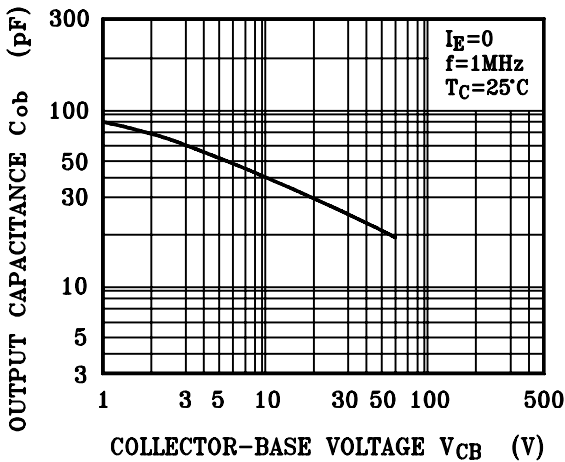

$P_c - T_a$

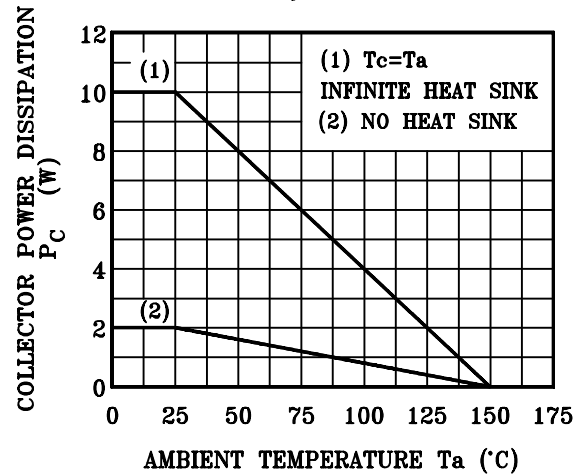

KTC2078

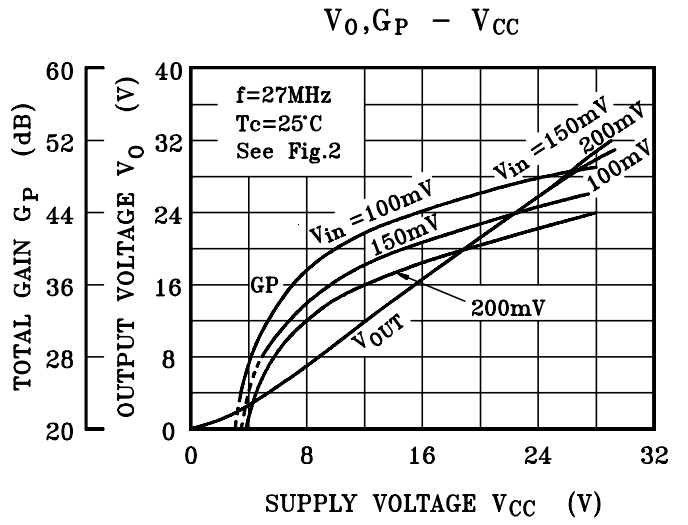
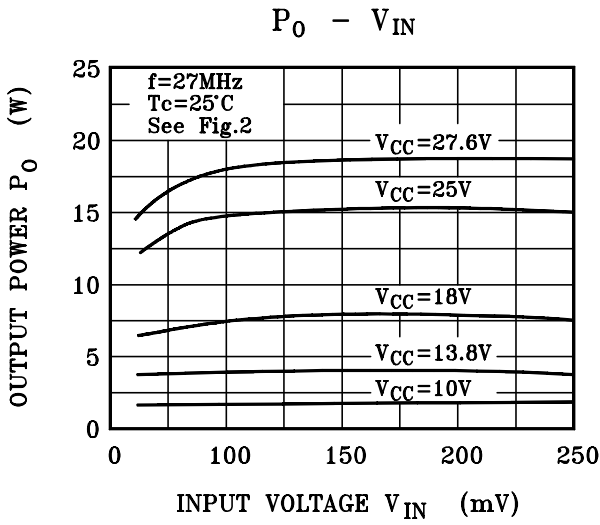

80% MODULATION SPECTRUM
EMISSION LIMITATION (FCC)

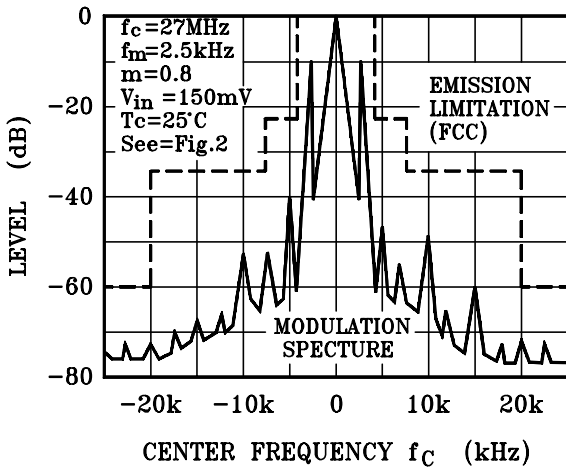

85% MODULATION SPECTRUM
EMISSION LIMITATION (FCC)

