

HIGH FREQUENCY APPLICATION.  
HF, VHF BAND AMPLIFIER APPLICATION.

### FEATURES

- High Power Gain :  $G_{pe}=30\text{dB(Typ.)}$  ( $f=10.7\text{MHz}$ ).
- Recommended for FM IF, OSC Stage and AM CONV, IF Stage.

### MAXIMUM RATINGS( $T_a=25^\circ\text{C}$ )

CHARACTERISTIC	SYMBOL	RATING	UNIT
Collector-Base Voltage	$V_{CBO}$	35	V
Collector-Emitter Voltage	$V_{CEO}$	30	V
Emitter-Base Voltage	$V_{EBO}$	4	V
Collector Current	$I_C$	50	mA
Emitter Current	$I_E$	-50	mA
Collector Power Dissipation	$P_C$	400	mW
Junction Temperature	$T_j$	150	$^\circ\text{C}$
Storage Temperature Range	$T_{stg}$	-55~150	$^\circ\text{C}$

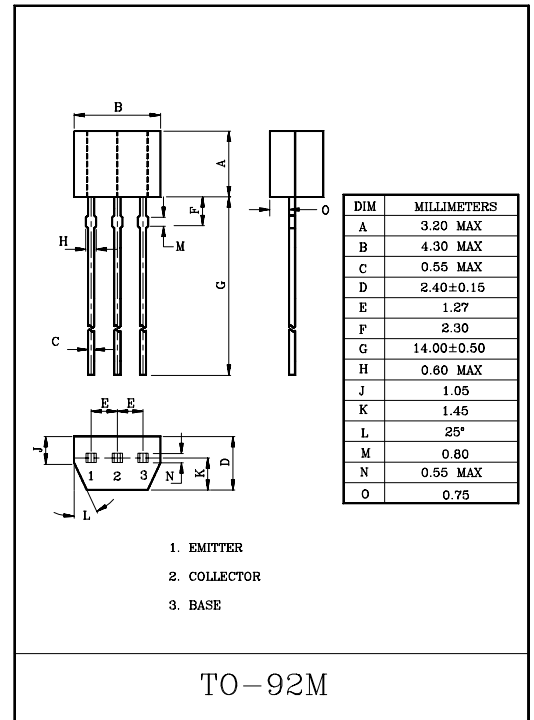

### ELECTRICAL CHARACTERISTICS ( $T_a=25^\circ\text{C}$ )

CHARACTERISTIC	SYMBOL	TEST CONDITION	MIN.	TYP.	MAX.	UNIT
Collector Cut-off Current	$I_{CBO}$	$V_{CB}=35\text{V}, I_E=0$	-	-	0.1	$\mu\text{A}$
Emitter Cut-off Current	$I_{EBO}$	$V_{EB}=4\text{V}, I_C=0$	-	-	1.0	$\mu\text{A}$
DC Current Gain	$h_{FE}(\text{Note})$	$V_{CE}=12\text{V}, I_C=2\text{mA}$	40	-	240	
Collector-Emitter Saturation Voltage	$V_{CE(sat)}$	$I_C=10\text{mA}, I_B=1\text{mA}$	-	-	0.4	V
Base-Emitter Saturation Voltage	$V_{BE(sat)}$	$I_C=10\text{mA}, I_B=1\text{mA}$	-	-	1.0	V
Transition Frequency	$f_T$	$V_{CE}=10\text{V}, I_C=1\text{mA}$	100	-	-	MHz
Collector Output Capacitance	$C_{ob}$	$V_{CB}=10\text{V}, I_E=0, f=1\text{MHz}$	-	2.0	3.2	pF
Collector-Base Time Constant	$C_c \cdot r_{bb}$	$V_{CE}=10\text{V}, I_E=-1\text{mA}, f=30\text{MHz}$	10	-	50	pS
Power Gain	$G_{pe}$	$V_{CC}=6\text{V}, I_E=-1\text{mA}, f=10.7\text{MHz}$ (Fig.)	27	29	33	dB

Note :  $h_{FE}$  Classification R:40~80 , O:70~140 , Y:120~240

# KTC3193

Fig.  $G_{pe}$  TEST CIRCUIT

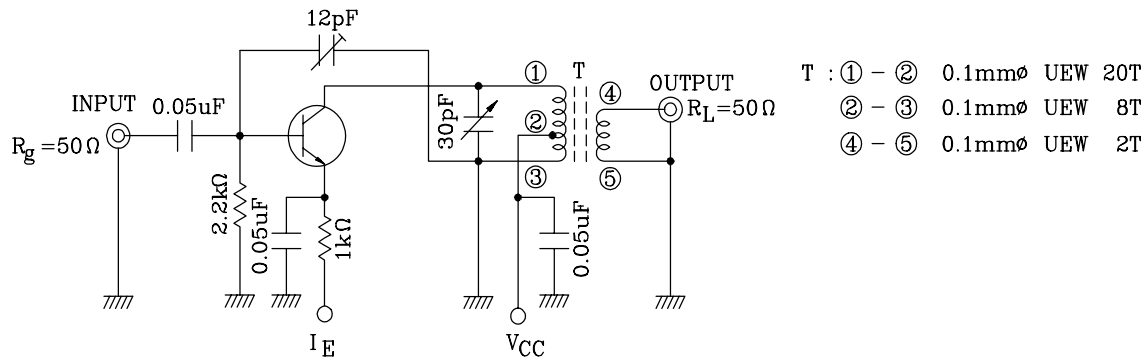

y PARAMETERS (Typ.)

(1) (COMMON EMITTER  $f=455\text{kHz}$ ,  $T_a=25^\circ\text{C}$ )

CHARACTERISTIC	SYMBOL	KTC3193-R	KTC3193-O	KTC3193-Y	UNIT
Collector-Emitter Voltage	$V_{CE}$	6	6	6	V
Emitter Current	$I_E$	-1	-1	-1	mA
Input Conductance	$g_{ie}$	0.58	0.41	0.26	mS
Input Capacitance	$C_{ie}$	53	46	38	pF
Output Conductance	$g_{oe}$	1.9	2.7	4.8	$\mu\text{S}$
Output Capacitance	$C_{oe}$	2.6	2.8	3.6	pF
Forward Transfer Admittance	$ y_{fe} $	38	38	38	mS
Phase Angle of Forward Transfer Admittance	$\theta_{fe}$	-0.79	-0.83	-0.92	$^\circ$
Reverse Transfer Admittance	$ y_{re} $	5.7	5.7	6.2	$\mu\text{S}$
Phase Angle of Reverse Transfer Admittance	$\theta_{re}$	-90	-90	-90	$^\circ$

(2) (COMMON EMITTER  $f=10.7\text{MHz}$ ,  $T_a=25^\circ\text{C}$ )

CHARACTERISTIC	SYMBOL	KTC3193-R	KTC3193-O	KTC3193-Y	UNIT
Collector-Emitter Voltage	$V_{CE}$	6	6	6	V
Emitter Current	$I_E$	-1	-1	-1	mA
Input Conductance	$g_{ie}$	1.04	0.85	0.65	mS
Input Capacitance	$C_{ie}$	49	43	36	pF
Output Conductance	$g_{oe}$	10	15	28	$\mu\text{S}$
Output Capacitance	$C_{oe}$	2.7	2.9	3.6	pF
Forward Transfer Admittance	$ y_{fe} $	37	37	37	mS
Phase Angle of Forward Transfer Admittance	$\theta_{fe}$	-9.6	-10.4	-11.5	$^\circ$
Reverse Transfer Admittance	$ y_{re} $	120	120	140	$\mu\text{S}$
Phase Angle of Reverse Transfer Admittance	$\theta_{re}$	-90	-90	-90	$^\circ$

# KTC3193

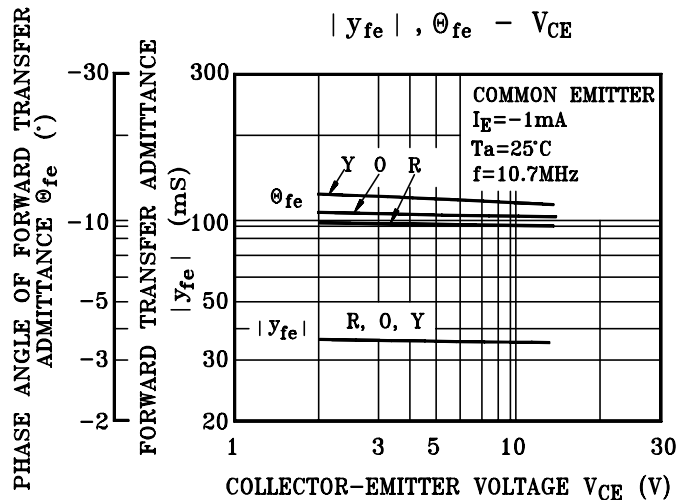
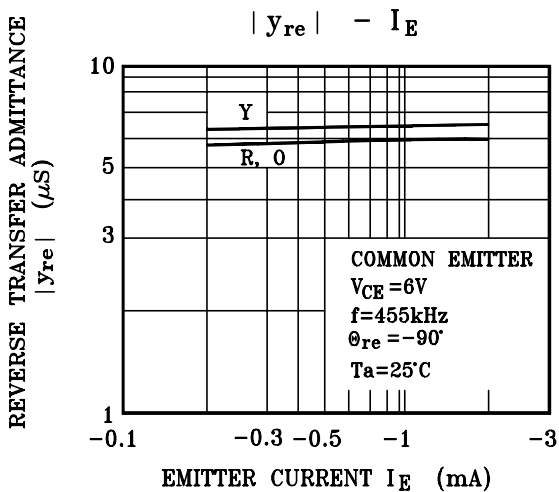
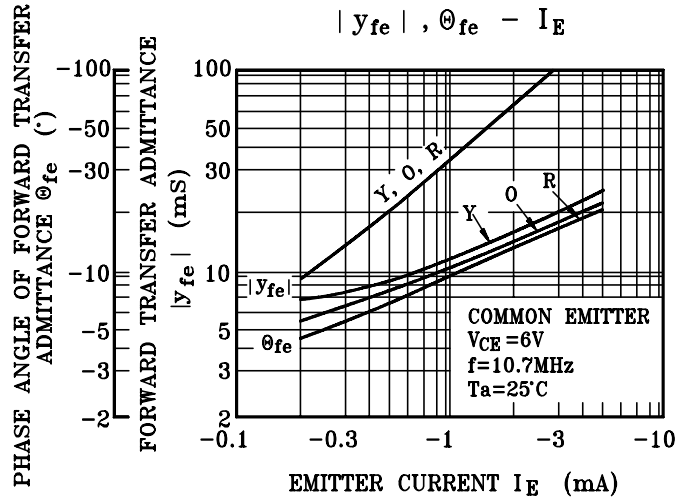
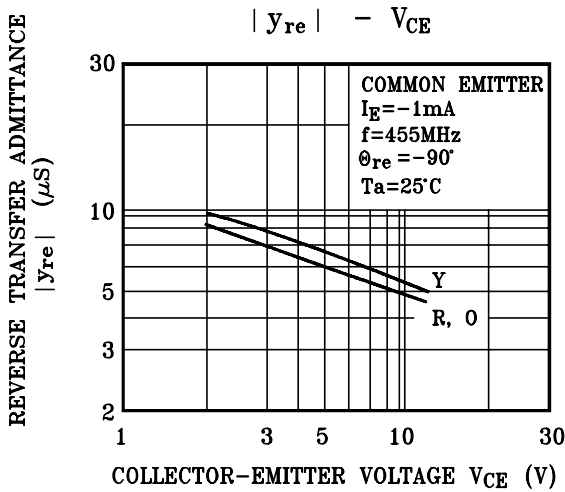
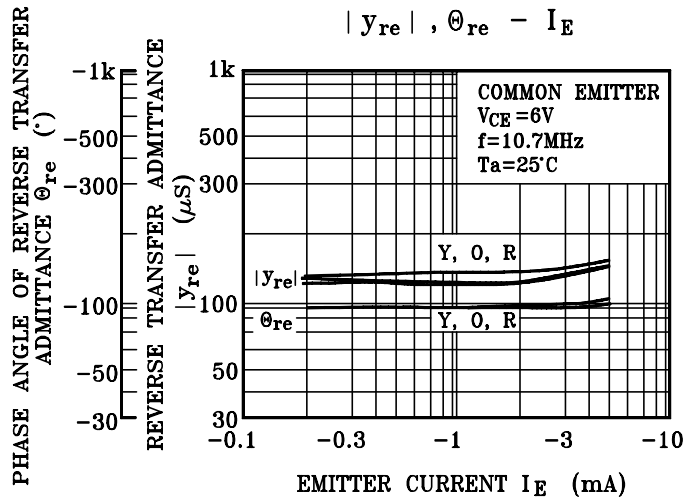
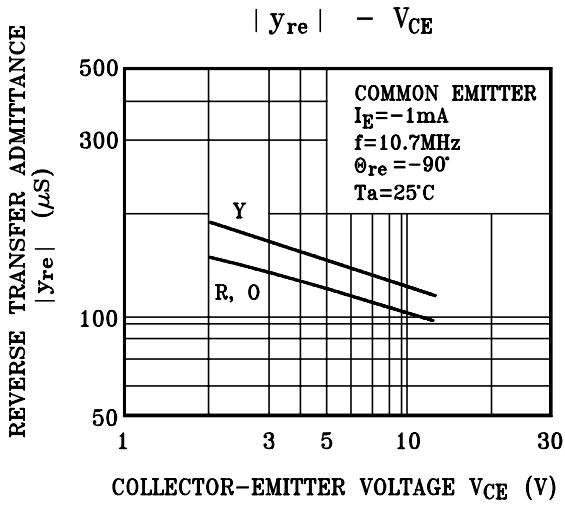

# KTC3193

