

Band pass filters for RF circuits of wireless data communication

- High stability and reliability with good performance and no adjustment.
- Wide and sharp pass band characteristics.
- Low insertion loss and deep stop band attenuation for interference.

MAXIMUM RATINGS (Ta=25°C)

ITEM	SYMBOL	RATING	UNIT
Input Signal Level	IS _{max}	10	dBm
DC Permissive Voltage	V _{DC}	0	V
Operating Temperature Range	T _{opr}	-10~+60	°C
Storage Temperature Range	T _{stg}	-40~+85	°C

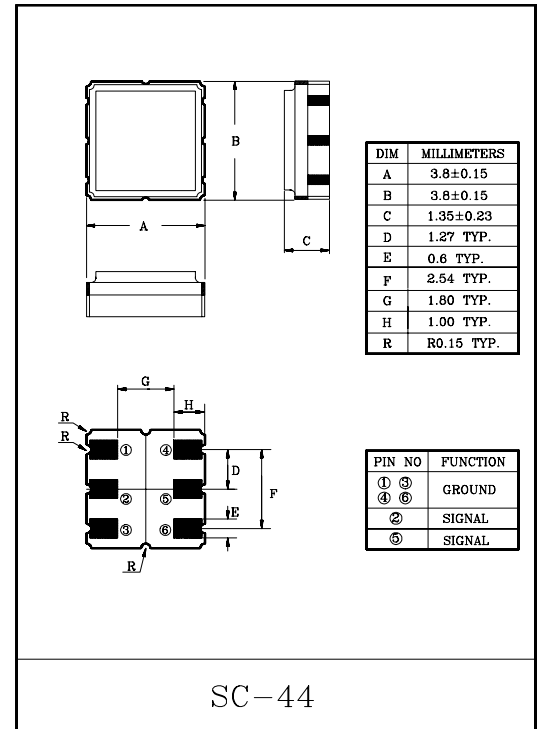

MARKING

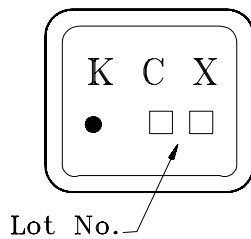

ELECTRICAL CHARACTERISTICS (Temperature 20±2°C, Humidity 65±5%)

ITEMS	SYMBOL	TEST CONDITION	MIN.	TYP.	MAX.	UNIT
Nominal Center Frequency	f ₀	-	-	939	-	MHz
Bandwidth	BW _{3dB}	-	f ₀ ±2.0	-	-	MHz
Insertion Loss	IL _{PASS}	f ₀ ±2.0MHz	-	-	4.0	dB
Ripple Level	A _{RIP}	f ₀ ±2.0MHz	-	-	1.5	dB
Rejection Level	IL _{STOP}	f ₀ -200~f ₀ -40MHz	45	-	-	dB
		f ₀ +50~f ₀ +200MHz	45	-	-	
Input/Output Impedance	Z _I (Z _O)	-	-	50Ω+10nH	-	-

KF939V

TEST CIRCUIT

REFERENCE LEVEL TEST CIRCUIT

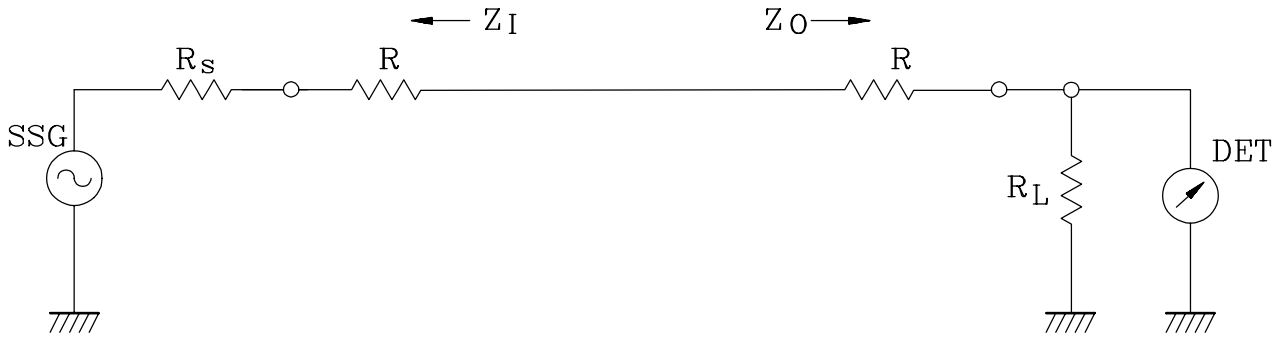

$R_s, R_L : 50\Omega$ (Internal Impedance of Source and Load)

$R : 0\Omega$

$$Z_I(Z_O) = R_s(R_L) + R$$

MEASUREMENT CIRCUIT

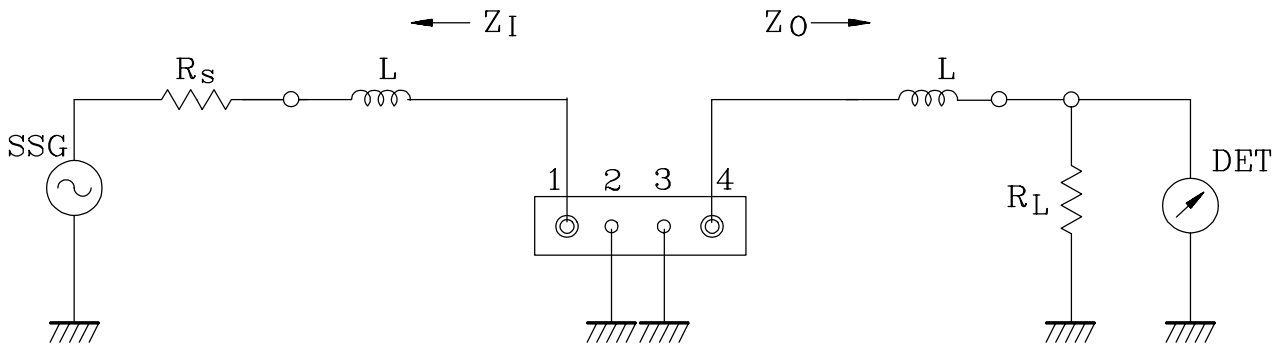

1: Input 2,3: Ground 4: Output

$R_s, R_L : 50\Omega$ (Internal Impedance of Source and Load)

$L : 10\text{nH}$

$$Z_I(Z_O) = R_s(R_L) + L$$

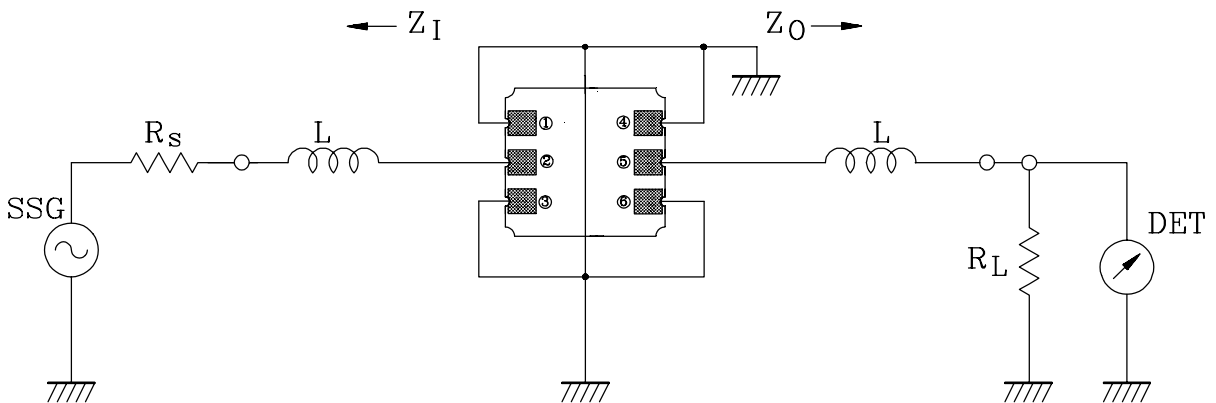

② INPUT ①, ③, ④, ⑥, GROUND ⑤ OUTPUT