

THREE TERMINAL NEGATIVE VOLTAGE REGULATORS -5V, -8V, -12V, -15V.

KIA79M × × Series of three-terminal regulators is available with fixed output voltages of -5V, -8V, -12V, and -15V. These devices need only one external component—a compensation capacitor at the output. The KIA79MXX series is packaged in the TO-220 power package, and is capable of supplying 0.5A of output current. These regulators employ internal current limiting, safe area protection, and thermal shutdown for protection against virtually all overload conditions. Low ground pin current of the KIA79MXX series allows output voltage to be easily boosted above the preset value with a resistor divider. The low quiescent current of these devices with a specified maximum change with line and load ensures good regulation in the voltage boosted mode.

FEATURES

- Thermal, Short Circuit and Safe Area Protection
- High Ripple Rejection.
- 0.5A Output Current
- 4% Tolerance on Preset Output Voltage.

MAXIMUM RATINGS (Ta=25 °C)

CHARACTERISTIC		SYMBOL	RATING	UNIT
Input Voltage		V _{IN}	-35	V
Power Dissipation	T _C =25 °C	P _D	20.8	W
	Without Heatsink		2.0	
Operating Junction Temperature		T _j	-40 ~ 150	°C
Storage Temperature		T _{stg}	-55 ~ 150	°C
Soldering Temperature (10 seconds)		T _{sol}	260	°C3

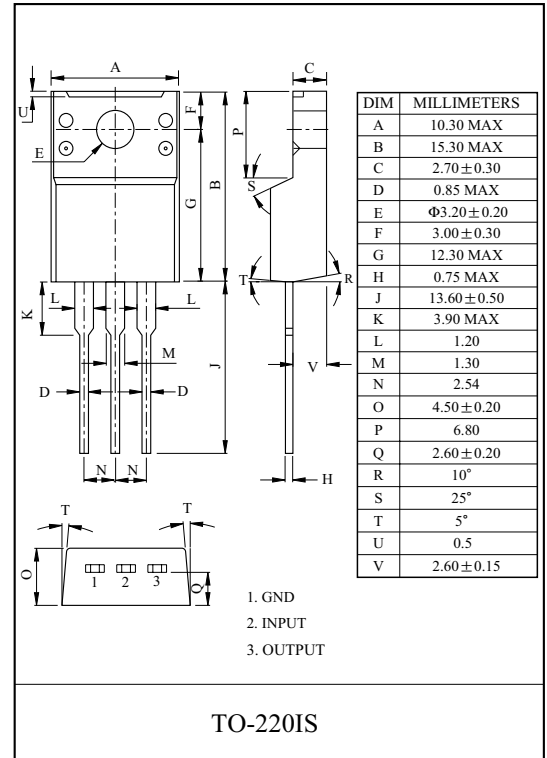

KIA79M05PI~KIA79M15PI

EQUIVALENT CIRCUIT

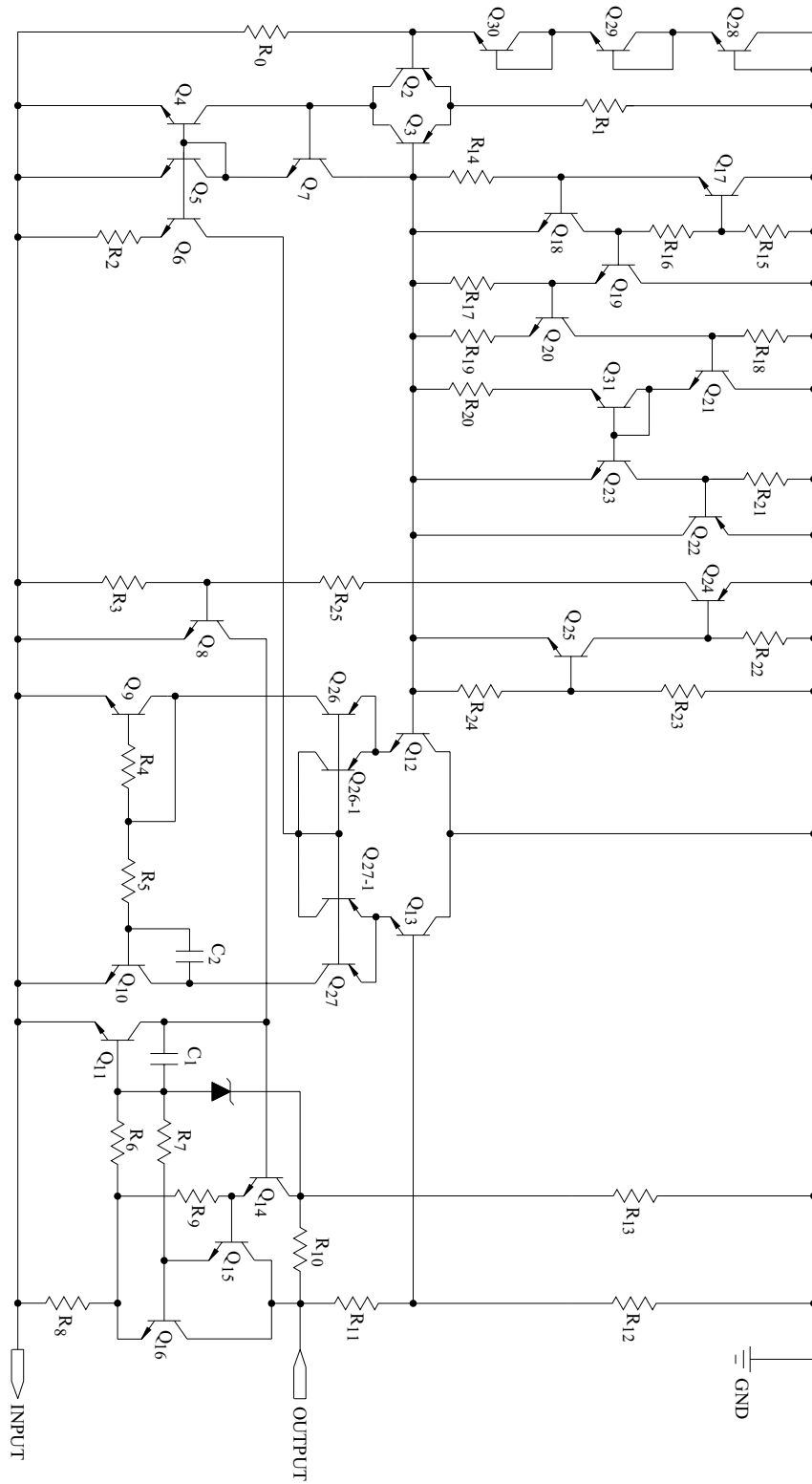

KIA79M05PI~KIA79M15PI

ELECTRICAL CHARACTERISTICS

KIA79M05PI

(unless otherwise specified : $V_{IN}=-10V$, $I_{OUT}=350mA$, $C_{IN}=0.33\mu F$, $C_{OUT}=1\mu F$)

CHARACTERISTIC	SYMBOL	TEST CONDITION	MIN.	TYP.	MAX.	UNIT
Output Voltage	V_O	$T_j=25^\circ C$	-4.8	-5.0	-5.2	V
		$5mA \leq I_O \leq 350mA$, $7V \leq V_{IN} \leq -25V$	-4.75	-5.0	-5.25	
Line Regulation	$V_{Reg \text{ Line}}$	$-7V \leq V_{IN} \leq -25V$, $T_j=25^\circ C$	-	7	50	mV
		$-8V \leq V_{IN} \leq -18V$, $T_j=25^\circ C$	-	2	30	
Load Regulation	$V_{Reg \text{ Load}}$	$5mA \leq I_O \leq 500mA$, $T_j=25^\circ C$	-	30	100	mV
Quiescent Current	I_B	$T_j=25^\circ C$	-	4	6	mA
Quiescent Current Change	ΔI_B	$5mA \leq I_O \leq 350mA$	-	-	0.4	mA
		$-8V \leq V_{IN} \leq -25V$	-	-	0.4	mA
Output Noise Voltage	V_{NO}	$f=10Hz \sim 100kHz$, $T_j=25^\circ C$	-	40	-	μV
Ripple Rejection	$R \cdot R$	$f=120Hz$, $-8V \leq V_{IN} \leq -18V$	55	60	-	dB
Dropout Voltage	V_D	$I_O=500mA$, $T_j=25^\circ C$	-	1.1	-	V
Short Circuit Current	I_{SC}	$T_j=25^\circ C$	-	800	-	mA
Output Voltage Drift	$\Delta V_O / \Delta T$	$I_O=5mA$, $T_j=0 \sim 125^\circ C$	-	-0.5	-	mV/ $^\circ C$

KIA79M05PI~KIA79M15PI

ELECTRICAL CHARACTERISTICS

KIA79M08PI

(unless otherwise specified : $V_{IN}=-14V$, $I_{OUT}=350mA$, $C_{IN}=0.33\mu F$, $C_{OUT}=1\mu F$)

CHARACTERISTIC	SYMBOL	TEST CONDITION	MIN.	TYP.	MAX.	UNIT
Output Voltage	V_O	$T_j=25^\circ C$	-7.7	-8.0	-8.3	V
		$5mA \leq I_O \leq 350mA$, $-10V \leq V_{IN} \leq -25V$	-7.6	-8.0	-8.4	
Line Regulation	$V_{Reg \text{ Line}}$	$-10V \leq V_{IN} \leq -25V$, $T_j=25^\circ C$	-	7	80	mV
		$-11V \leq V_{IN} \leq -21V$, $T_j=25^\circ C$	-	2	50	
Load Regulation	$V_{Reg \text{ Load}}$	$5mA \leq I_O \leq 500mA$, $T_j=25^\circ C$	-	30	160	mV
Quiescent Current	I_B	$T_j=25^\circ C$	-	4	6	mA
Quiescent Current Change	ΔI_B	$5mA \leq I_O \leq 350mA$	-	-	0.4	mA
		$-10V \leq V_{IN} \leq -25V$	-	-	0.4	mA
Output Noise Voltage	V_{NO}	$f=10Hz \sim 100kHz$, $T_j=25^\circ C$	-	60	-	μV
Ripple Rejection	$R \cdot R$	$f=120Hz$, $-11V \leq V_{IN} \leq -21V$	55	60	-	dB
Dropout Voltage	V_D	$I_O=500mA$, $T_j=25^\circ C$	-	1.1	-	V
Short Circuit Current	I_{SC}	$T_j=25^\circ C$	-	800	-	mA
Output Voltage Drift	$\Delta V_O / \Delta T$	$I_O=5mA$, $T_j=0 \sim 125^\circ C$	-	-0.65	-	$mV/^\circ C$

KIA79M05PI~KIA79M15PI

ELECTRICAL CHARACTERISTICS

KIA79M12PI

(unless otherwise specified : $V_{IN}=-19V$, $I_{OUT}=350mA$, $C_{IN}=0.33\mu F$, $C_{OUT}=1\mu F$)

CHARACTERISTIC	SYMBOL	TEST CONDITION	MIN.	TYP.	MAX.	UNIT
Output Voltage	V_O	$T_j=25^\circ C$	-11.5	-12	-12.5	V
		$5mA \leq I_O \leq 350mA$, $-14.5V \leq V_{IN} \leq -27V$	-11.4	-12	-12.6	
Line Regulation	$V_{Reg \text{ Line}}$	$-14.5V \leq V_{IN} \leq -30V$, $T_j=25^\circ C$	-	5	80	mV
		$-15V \leq V_{IN} \leq -25V$, $T_j=25^\circ C$	-	3	50	
Load Regulation	$V_{Reg \text{ Load}}$	$5mA \leq I_O \leq 500mA$, $T_j=25^\circ C$	-	30	240	mV
Quiescent Current	I_B	$T_j=25^\circ C$	-	4	6	mA
Quiescent Current Change	ΔI_B	$5mA \leq I_O \leq 350mA$	-	-	0.4	mA
		$-14.5V \leq V_{IN} \leq -30V$	-	-	0.4	mA
Output Noise Voltage	V_{NO}	$f=10Hz \sim 100kHz$, $T_a=25^\circ C$	-	75	-	μV
Ripple Rejection	$R \cdot R$	$f=120Hz$, $-15V \leq V_{IN} \leq -25V$	55	60	-	dB
Dropout Voltage	V_D	$I_O=500mA$, $T_j=25^\circ C$	-	1.1	-	V
Short Circuit Current	I_{SC}	$T_j=25^\circ C$	-	800	-	mA
Output Voltage Drift	$\Delta V_O / \Delta T$	$I_O=5mA$, $T_j=0 \sim 125^\circ C$	-	-0.8	-	mV/ $^\circ C$

KIA79M05PI~KIA79M15PI

ELECTRICAL CHARACTERISTICS

KIA79M15PI

(unless otherwise specified : $V_{IN}=-23V$, $I_{OUT}=350mA$, $C_{IN}=0.33\mu F$, $C_{OUT}=1\mu F$)

CHARACTERISTIC	SYMBOL	TEST CONDITION	MIN.	TYP.	MAX.	UNIT
Output Voltage	V_O	$T_j=25^\circ C$	-14.4	-15	-15.6	V
		$5mA \leq I_O \leq 350mA$, $-18V \leq V_{IN} \leq -30V$	-14.25	-15	-15.75	
Line Regulation	$V_{Reg Line}$	$-17.5V \leq V_{IN} \leq -30V$, $T_j=25^\circ C$	-	5	80	mV
		$-18V \leq V_{IN} \leq -28V$, $T_j=25^\circ C$	-	3	50	
Load Regulation	$V_{Reg Load}$	$5mA \leq I_O \leq 500mA$, $T_j=25^\circ C$	-	30	240	mV
Quiescent Current	I_B	$T_j=25^\circ C$	-	4	6	mA
Quiescent Current Change	ΔI_B	$5mA \leq I_O \leq 350mA$	-	-	0.4	mA
		$-17.5V \leq V_{IN} \leq -30V$	-	-	0.4	mA
Output Noise Voltage	V_{NO}	$f=10Hz \sim 100kHz$, $T_a=25^\circ C$	-	90	-	μV
Ripple Rejection	$R \cdot R$	$f=120Hz$, $-18V \leq V_{IN} \leq -28V$	55	60	-	dB
Dropout Voltage	V_D	$I_O=500mA$, $T_j=25^\circ C$	-	1.1	-	V
Short Circuit Current	I_{SC}	$T_j=25^\circ C$	-	800	-	mA
Output Voltage Drift	$\Delta V_O / \Delta T$	$I_O=5mA$, $T_j=0 \sim 125^\circ C$	-	-1.0	-	mV/ $^\circ C$

KIA79M05PI~KIA79M15PI

OUTPUT VOLTAGE vs TEMPERATURE

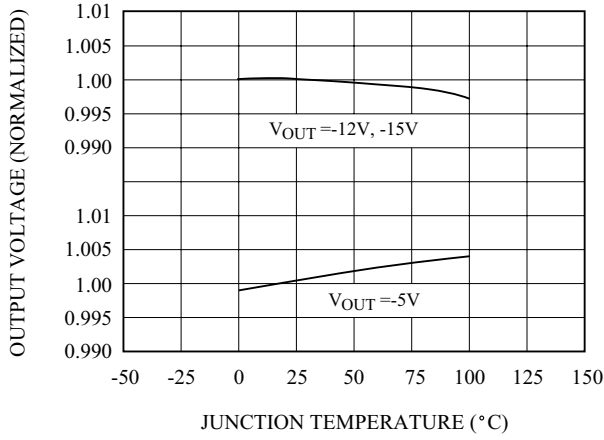

RIPPLE REJECTION

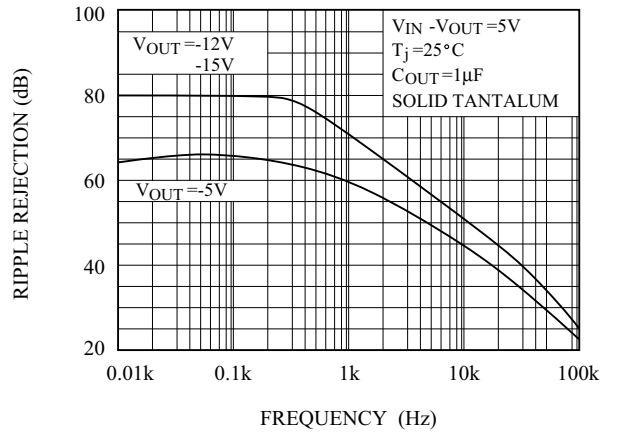

OUTPUT IMPEDANCE

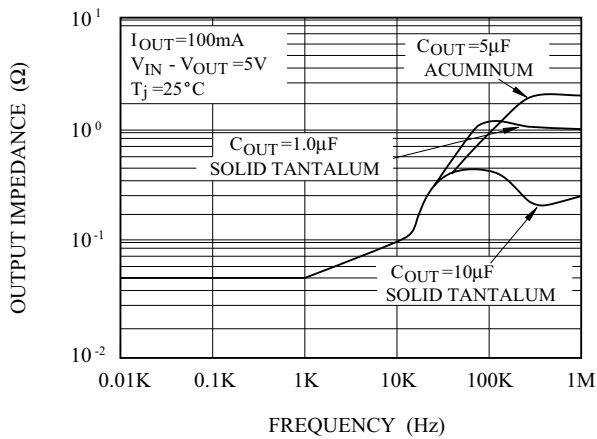

MINIMUM INPUT-OUTPUT DIFFERENTIAL

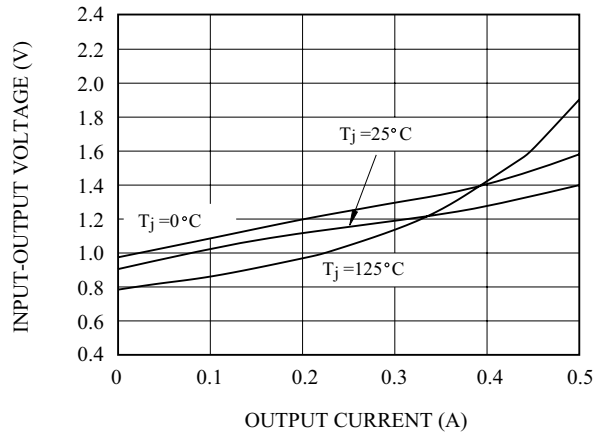

INPUT VOLTAGE

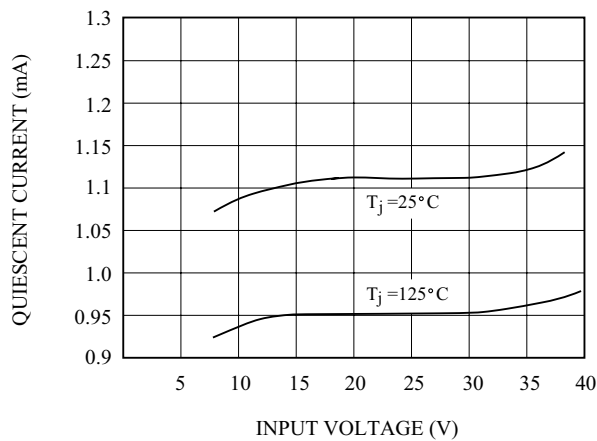

QUIESCENT CURRENT vs LOAD CURRENT

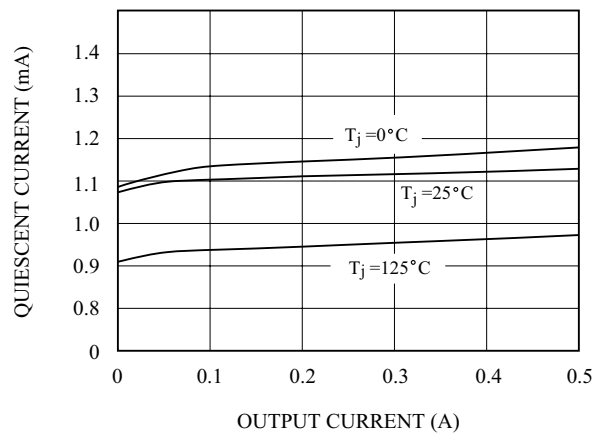

KIA79M05PI~KIA79M15PI

SHORT-CIRCUIT CURRENT

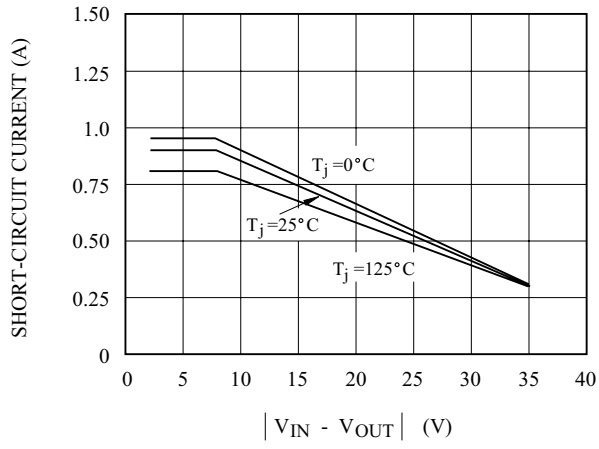

$P_D - T_a$

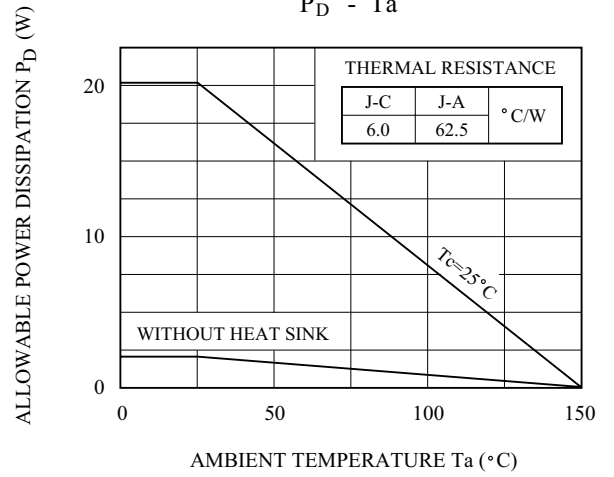

KIA79M05PI~KIA79M15PI

Design Considerations

The KIA79MXX fixed voltage regulator series have thermal overload protection from excessive power, internal short circuit protection which limits the circuit's maximum current, and output transistor safe-area compensation for reducing the output current as the voltage across the pass transistor is increased.

Although the internal power dissipation is limited, the junction temperature must be kept below the maximum specified temperature in order to meet data sheet specifications. To calculate the maximum junction temperature or heat sink required, the following thermal resistance values should be used ;

PACKAGE	θ_{JC} (°C/W)	θ_{JA} (°C/W)
TO-220	6.0	62.5

$$P_{D\text{MAX}} = \frac{T_{j\text{max}} - T_a}{\theta_{JC} + \theta_{CA}} \quad \text{or}$$

$$= \frac{T_{j\text{max}} - T_a}{\theta_{JA}} \quad (\text{Without a Heat Sink})$$

$$\theta_{CA} = \theta_{CS} + \theta_{SA}$$

Solving for T_j :

$$T_j = T_A + P_D (\theta_{JC} + \theta_{CA})$$

$$= T_A + P_D \theta_{JA} \quad (\text{Without a Heat Sink})$$

Where

T_j = Junction Temperature

T_A = Ambient Temperature

P_D = Power Dissipation

θ_{JC} = Junction to Case Thermal Resistance

θ_{CA} = Case to Ambient Thermal Resistance

θ_{CS} = Case to Heat Sink Thermal Resistance

θ_{SA} = Heat Sink to Ambient Thermal Resistance

θ_{JA} = Junction to Ambient Thermal Resistance

Typical Applications

Bypass capacitors are necessary for stable operation of the KIA79MXX series of regulators over the input voltage and output current ranges. Output bypass capacitors will improve the transient response of the regulator.

The bypass capacitors (2.2 μ F on the input, 1.0 μ F on the output), Should be ceramic or solid tantalum which have good high frequency characteristics. If aluminum electrolytics are used, their values should be 10 μ F or larger. The bypass capacitors should be mounted with the shortest leads, and if possible, directly across the regulator terminals.

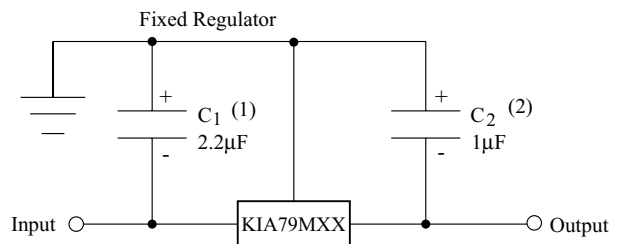

- (1) Required if regulator is separated from filter capacitor by more than 3". For value given, capacitor must be solid tantalum. 25 μ F aluminum electrolytic may be substituted.
- (2) Required for stability. For value given, capacitor must be solid tantalum. 25 μ F aluminum electrolytic may be substituted. Values given may be increased without limit. For output capacitance in excess of 100 μ F, a high current diode from input to output (1N4001, etc.) will protect the regulator from momentary input shorts.

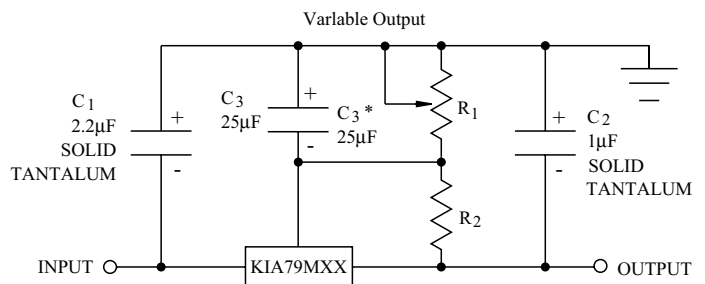

* Improves transient response and ripple rejection.

Do not increase beyond $50 \leq F$.

$$V_{\text{OUT}} = V_{\text{SET}} \left(\frac{R_1 + R_2}{R_2} \right)$$

Select R2 as follows :

KIA79M05	300 Ω
KIA79M08	470 Ω
KIA79M12	750 Ω
KIA79M15	1k Ω