

GENERAL PURPOSE APPLICATION.  
SWITCHING APPLICATION.

### FEATURES

- A super-minimold package houses 2 transistor.
- Excellent temperature response between these 2 transistor.
- High pairing property in  $h_{FE}$ .
- The following characteristics are common for  $Q_1, Q_2$ .

### MAXIMUM RATING (Ta=25 °C)

CHARACTERISTIC	SYMBOL	RATING	UNIT
Collector-Base Voltage	$V_{CBO}$	60	V
Collector-Emitter Voltage	$V_{CEO}$	50	V
Emitter-Base Voltage	$V_{EBO}$	5	V
Collector Current	$I_C$	150	mA
Base Current	$I_B$	30	mA
Collector Power Dissipation	$P_C^*$	200	mW
Junction Temperature	$T_j$	150	°C
Storage Temperature Range	$T_{stg}$	-55 ~ 150	°C

\* Total Rating

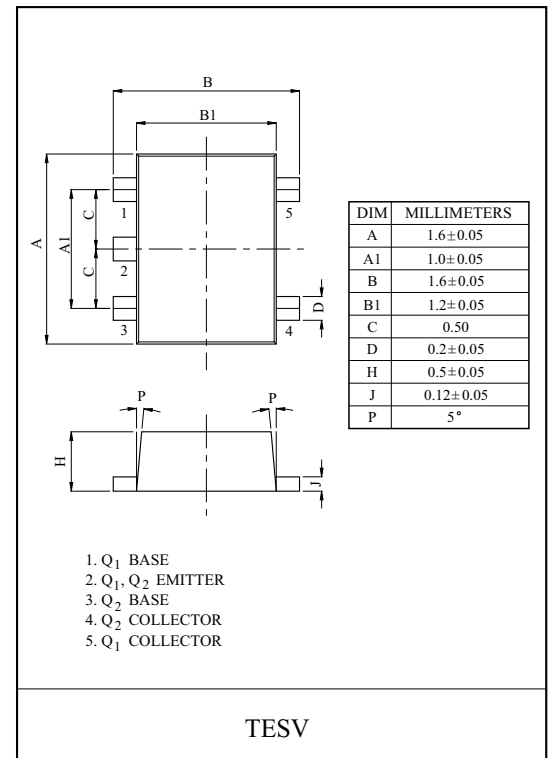

### EQUIVALENT CIRCUIT (TOP VIEW)

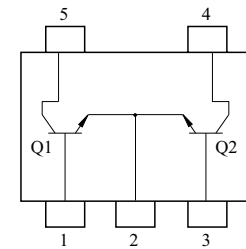

### ELECTRICAL CHARACTERISTICS (Ta=25 °C)

CHARACTERISTIC	SYMBOL	TEST CONDITION	MIN.	TYP.	MAX.	UNIT.
Collector Cut-off Current	$I_{CBO}$	$V_{CB}=60V, I_E=0$	-	-	0.1	$\mu A$
Emitter Cut-off Current	$I_{EBO}$	$V_{EB}=5V, I_C=0$	-	-	0.1	$\mu A$
DC Current Gain	$h_{FE}$ (Note)	$V_{CE}=6V, I_C=2mA$	120	-	400	
Collector-Emitter Saturation Voltage	$V_{CE(sat)}$	$I_C=100mA, I_B=10mA$	-	0.1	0.25	V
Transition Frequency	$f_T$	$V_{CE}=10V, I_C=1mA$	80	-	-	MHz
Collector Output Capacitance	$C_{ob}$	$V_{CB}=10V, I_E=0, f=1MHz$	-	2	3.5	pF
Noise Figure	NF	$V_{CE}=6V, I_C=0.1mA, f=1kHz, R_g=10k\Omega$	-	1.0	10	dB

Note :  $h_{FE}$  Classification Y(4):120 ~ 240, GR(6):200 ~ 400

### Marking

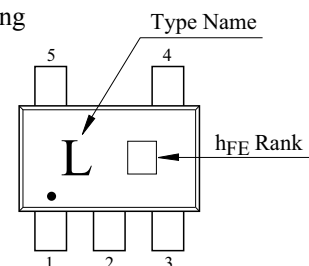

# KTC601E

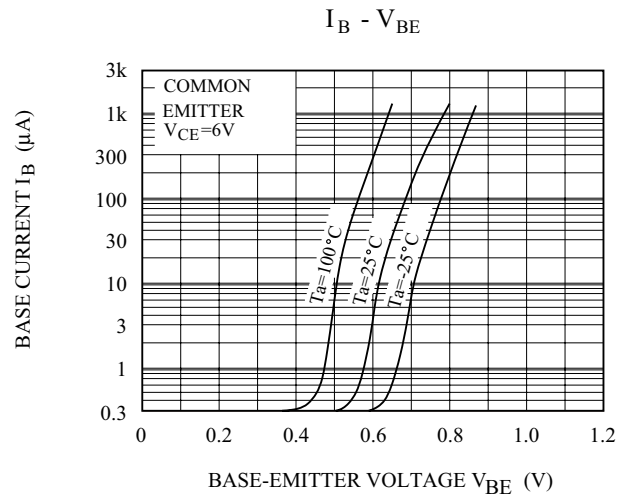
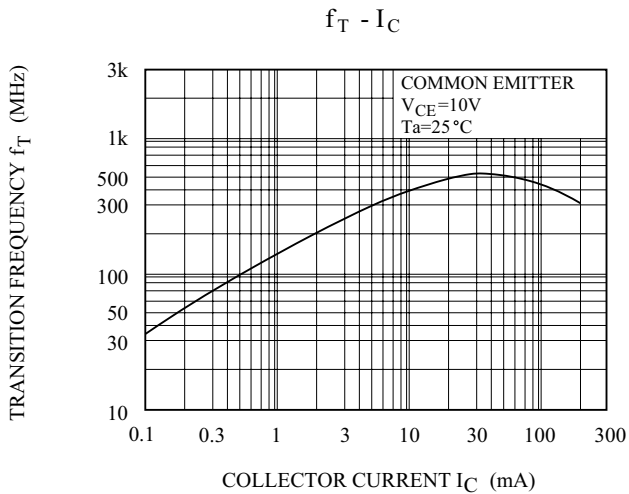
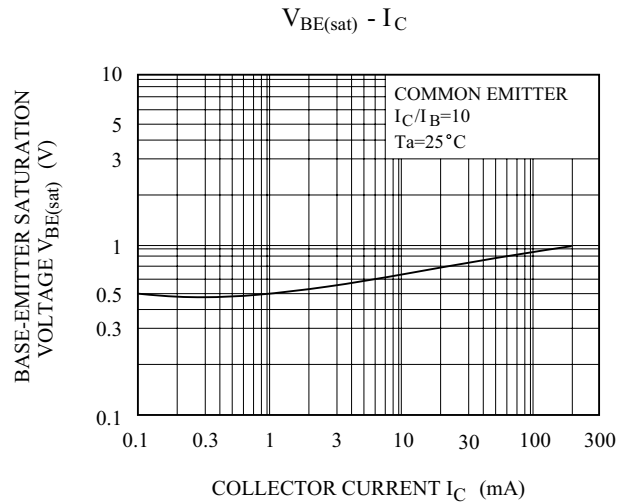
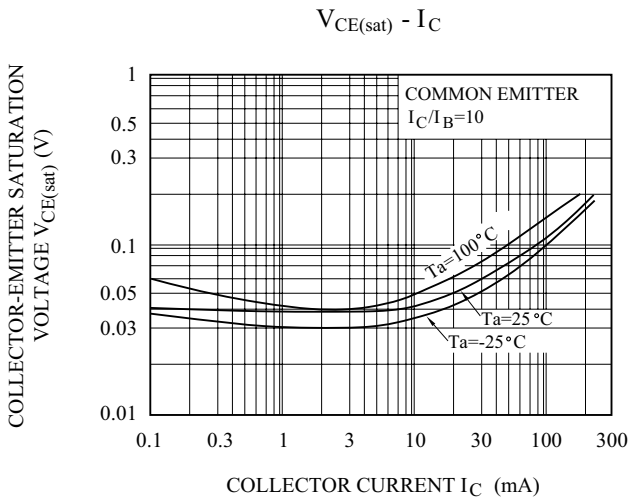
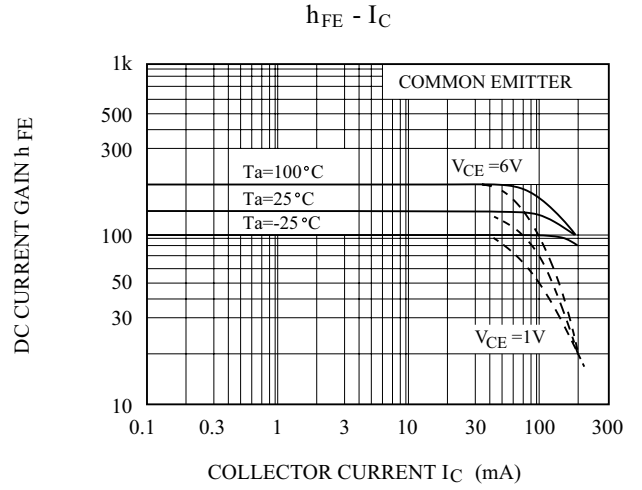
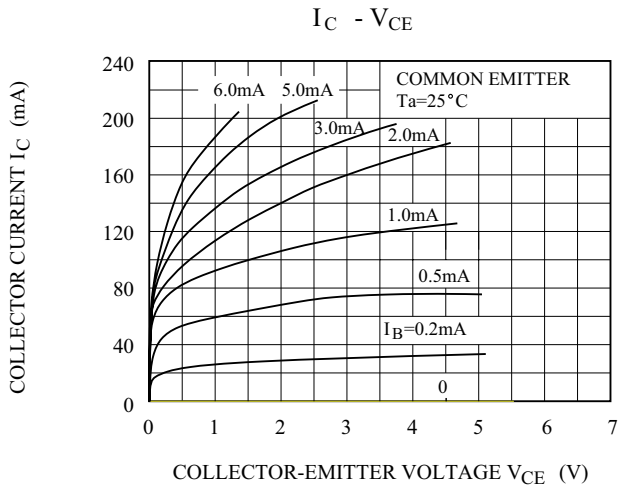

# KTC601E

---

