

ALTERNATOR DIODE FOR AUTOMOTIVE APPLICATION.

FEATURES

- Average Forward Current : $I_O=50A$.
- Zener Voltage : 37V(Typ.)

POLARITY

E50A37VBS (+ Type)

E50A37VBR (- Type)

MAXIMUM RATING (Ta=25°C)

CHARACTERISTIC	SYMBOL	RATING	UNIT
Average Forward Current	$I_{F(AV)}$	50	A
Peak 1 Cycle Surge Current	I_{FSM}	300 (60Hz)	A
Repetitive Peak Reverse Surge Current (Pulse width=10mS)	I_{RSM}	50	A
Transient Peak Reverse Voltage	V_{RSM}	34	V
Peak Reverse Voltage	V_{RM}	32	V
Junction Temperature	T_j	-40 ~ 215	°C
Storage Temperature Range	T_{stg}	-40 ~ 215	°C

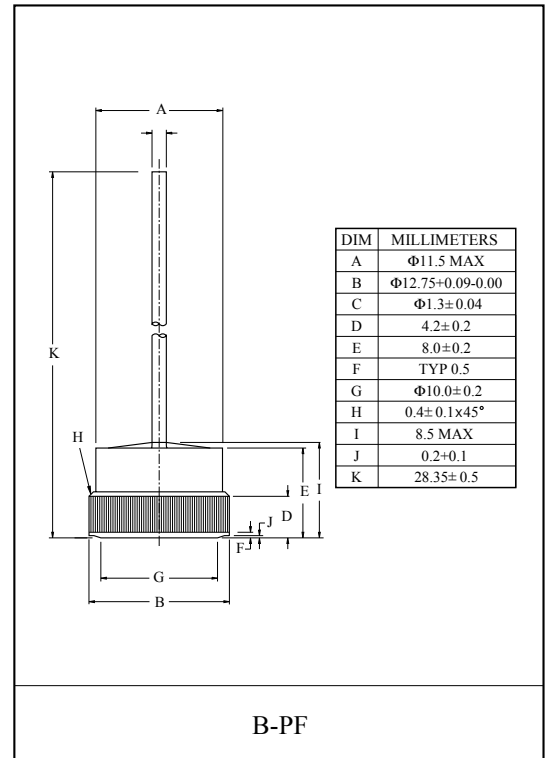

ELECTRICAL CHARACTERISTICS (Ta=25°C)

CHARACTERISTIC	SYMBOL	TEST CONDITION	MIN.	TYP.	MAX.	UNIT
Forward Voltage	V_F	$I_{FM}=100A$	-	-	1.10	V
Zener Voltage	V_Z	$I_Z=10mA$	34	37	40	V
Reverse Current	I_R	$V_R=32V$	-	-	10	μA
Transient Thermal Resistance	ΔV_F	$I_{FM}=100A, I_M=100mA, Pw=100mS$	-	-	60	mV
Breakdown Voltage	V_{br}	$I_{RSM}=50A, Pw=10mS$	-	-	55	V
Temperature Coefficient	α_T	$I_Z=10mA$	-	27	-	mV/°C
Reverse Leakage Current Under High Temperature	HI_R	$T_a=150^\circ C, V_R=32V$	-	-	100	μA
Temperature Resistance	R_{th}	DC total junction to case	-	-	0.6	°C/W