

Kingbright®

30mm (1.2 INCH) 5x7 DOT MATRIX DISPLAYS

TA12-11
TBA12-11
TBA12-12
TBA12-22

TC12-11
TBC12-11
TBC12-12
TBC12-22

Features

- 1.2 INCH MATRIX HEIGHT.
- DOT SIZE 3mm.
- LOW CURRENT OPERATION.
- HIGH CONTRAST AND LIGHT OUTPUT.
- COMPATIBLE WITH USASCII AND EBCDIC CODES.
- COLUMN CATHODE AND COLUMN ANODE AVAILABLE.
- EASY MOUNTING ON P.C. BOARDS OR SOCKETS.
- CATEGORIZED FOR LUMINOUS INTENSITY,
- YELLOW AND GREEN CATEGORIZED FOR COLOR.
- MECHANICALLY RUGGED.
- STANDARD : GRAY FACE, WHITE DOT.

Description

The Bright Red source color devices are made with Gallium Phosphide Red Light Emitting Diode.

The Green source color devices are made with Gallium Phosphide Green Light Emitting Diode.

The High Efficiency Red source color devices are made with Gallium Arsenide Phosphide on Gallium Phosphide Orange Light Emitting Diode.

The Yellow source color devices are made with Gallium Arsenide Phosphide on Gallium Phosphide Yellow Light Emitting Diode.

The Super Bright Red source color devices are made with Gallium Aluminum Arsenide Red Light Emitting Diode.

Package Dimensions & Internal Circuit Diagram

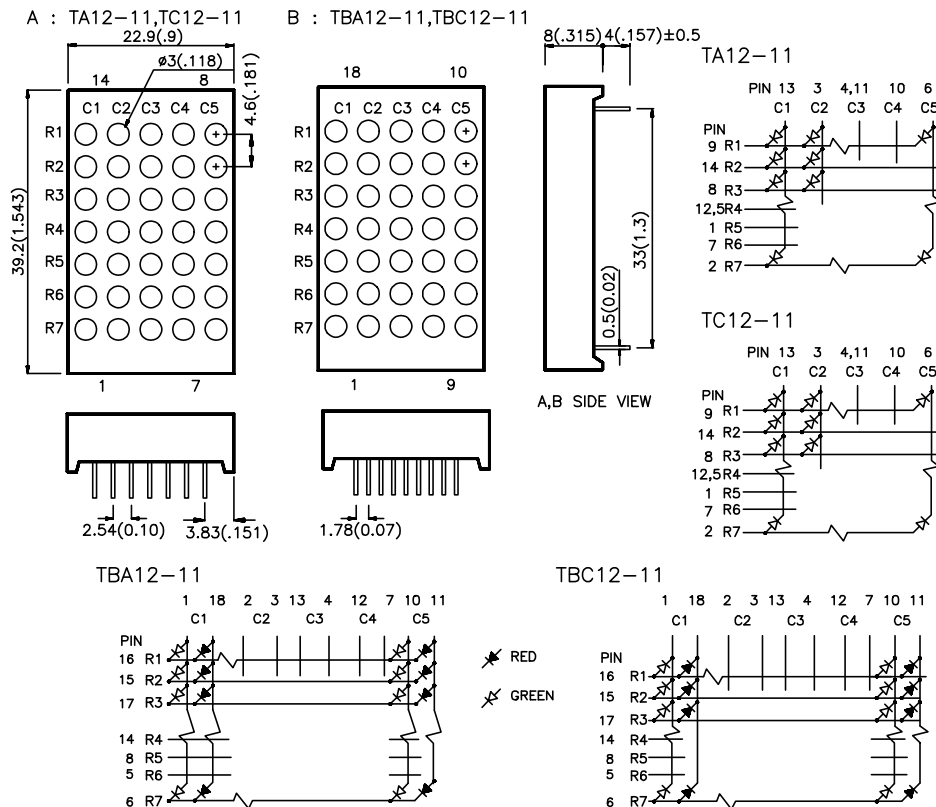

Package Dimensions & Internal Circuit Diagram

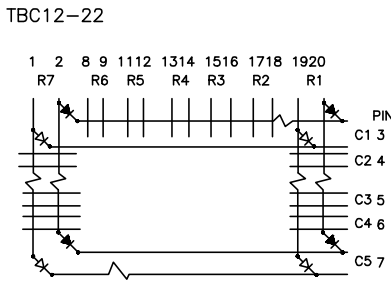
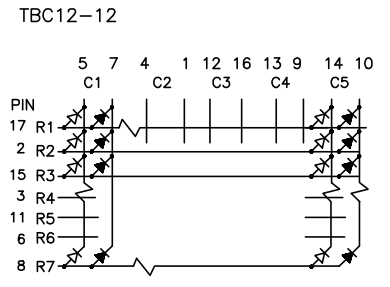
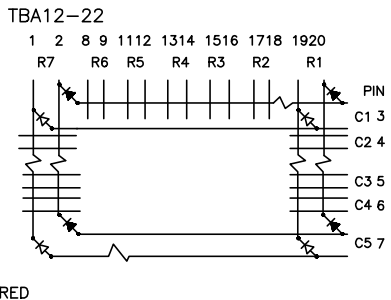
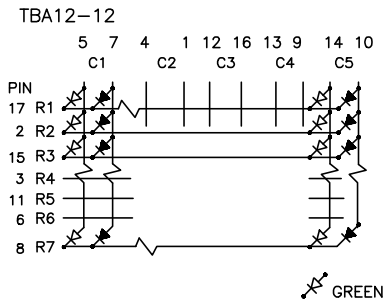
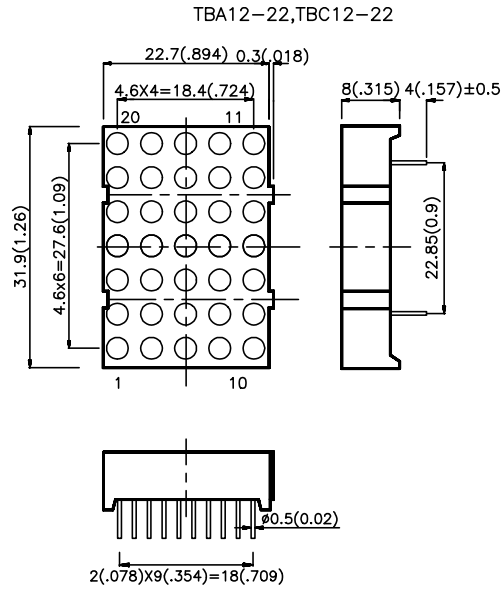
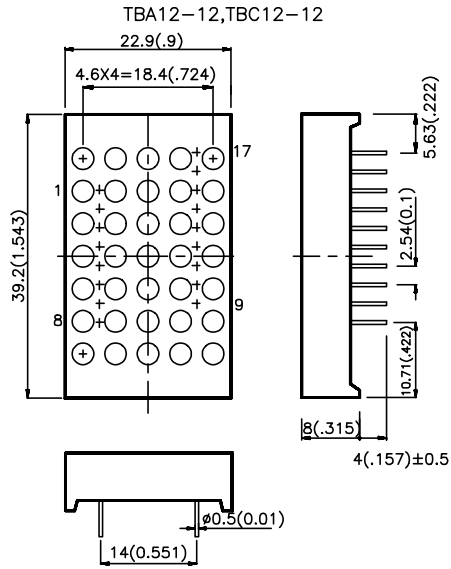

- Notes:
1. All dimensions are in millimeters (inches). Tolerance is $\pm 0.25(0.01)$ unless otherwise noted.
 2. Specifications are subjected to change without notice.

Selection Guide

Part No.	Dice	Iv (ucd) @ 10 mA		Description
		Min.	Max.	
TA12-11HWA	BRIGHT RED (GaP)	560	1400	Column Anode
TC12-11HWA				Column Cathode
TA12-11EWA	HIGH EFFICIENCY RED (GaAsP/GaP)	3600	9000	Column Anode
TC12-11EWA				Column Cathode
TA12-11GWA	GREEN (GaP)	2200	5600	Column Anode
TC12-11GWA				Column Cathode
TA12-11YWA	YELLOW (GaAsP/GaP)	2200	5600	Column Anode
TC12-11YWA				Column Cathode
TA12-11SRWA	SUPER BRIGHT RED (GaAlAs)	5600	14000	Column Anode
TC12-11SRWA				Column Cathode
TBA12-11EGWA	HIGH EFFICIENCY RED (GaAsP/GaP) GREEN (GaP)	2200	9000	Column Anode
TBC12-11EGWA		2200	9000	Column Cathode
TBA12-12EGWA	HIGH EFFICIENCY RED (GaAsP/GaP) GREEN (GaP)	2200	9000	Column Anode
TBC12-12EGWA		2200	9000	Column Cathode
TBA12-22EGWA	HIGH EFFICIENCY RED (GaAsP/GaP) GREEN (GaP)	2200	9000	Column Anode
TBC12-22EGWA		2200	9000	Column Cathode

Electrical / Optical Characteristics at T_A=25°C

Symbol	Parameter	Device	Typ.	Max.	Units	Test Conditions
λ_{peak}	Peak Wavelength	Bright Red High Efficiency Red Green Yellow Super Bright Red	700 625 565 590 660		nm	IF=20mA
$\Delta\lambda_{1/2}$	Spectral Line Halfwidth	Bright Red High Efficiency Red Green Yellow Super Bright Red	45 45 30 35 20		nm	IF=20mA
C	Capacitance	Bright Red High Efficiency Red Green Yellow Super Bright Red	40 12 45 10 95		pF	VF=0V;f=1MHz
V _F	Forward Voltage	Bright Red High Efficiency Red Green Yellow Super Bright Red	2.0 2.0 2.2 2.1 1.85	2.5 2.5 2.5 2.5 2.5	V	IF=20mA
I _R	Reverse Current	All	10		uA	VR = 5V

Absolute Maximum Ratings at $T_A=25^\circ\text{C}$

Parameter	Bright Red	High Efficiency Red	Green	Yellow	Super Bright Red	Units
Power dissipation	120	105	105	105	100	mW
DC Forward Current	25	30	25	30	30	mA
Peak Forward Current [1]	150	150	150	150	150	mA
Reverse Voltage	5	5	5	5	5	V
Operating/Storage Temperature	-40°C To +85°C					
Lead Soldering Temperature [2]	260°C For 5 Seconds					

Notes:

- 1/10 Duty Cycle, 0.1ms Pulse Width.
2. 4mm below package base.

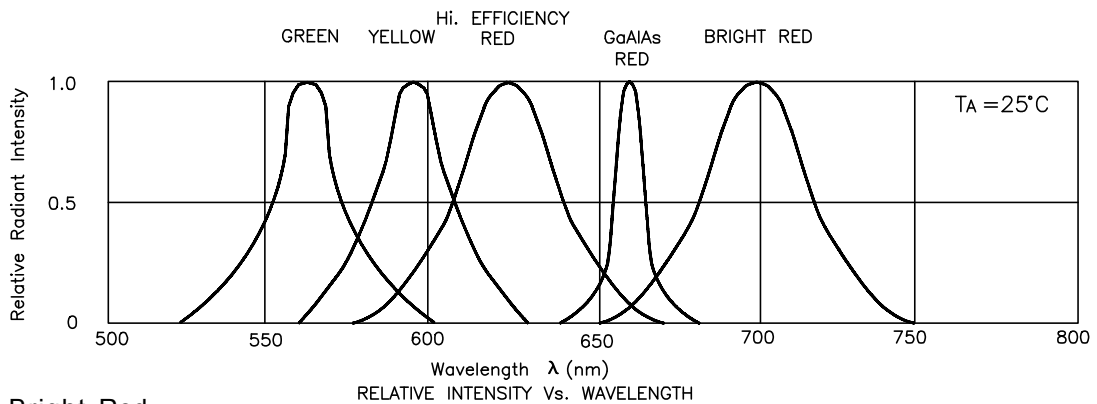

Bright Red

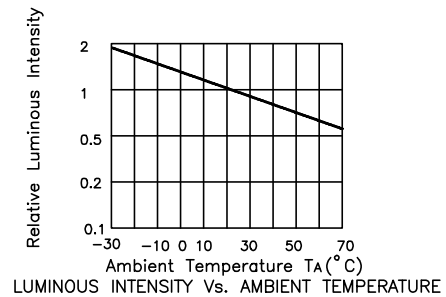
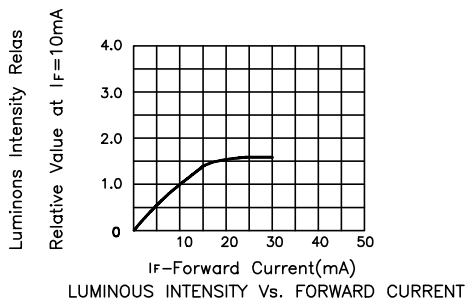
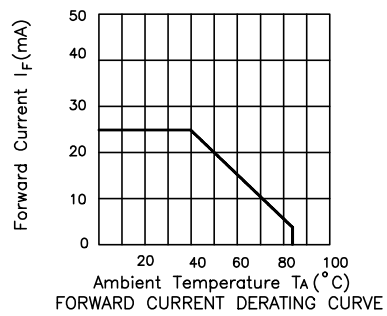
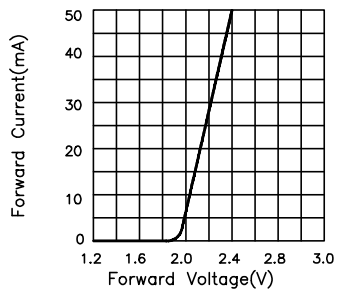

High Efficiency Red

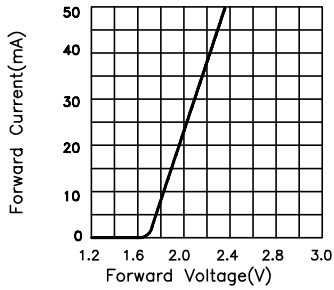

FORWARD CURRENT Vs. FORWARD VOLTAGE

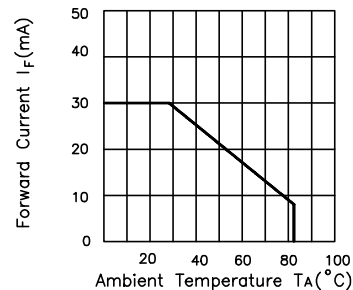

FORWARD CURRENT DERATING CURVE

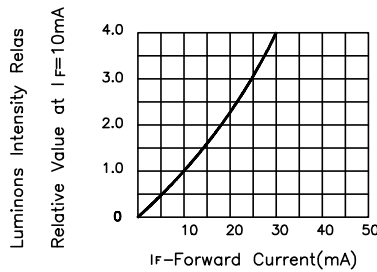

LUMINOUS INTENSITY Vs. FORWARD CURRENT

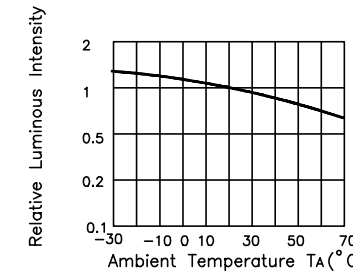

LUMINOUS INTENSITY Vs. AMBIENT TEMPERATURE

Green

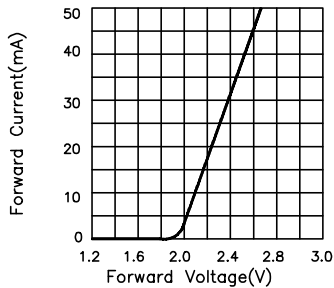

FORWARD CURRENT Vs. FORWARD VOLTAGE

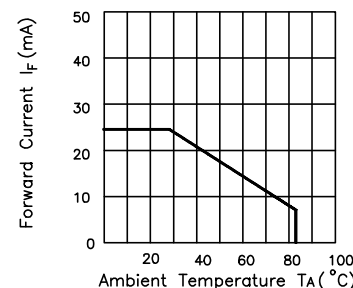

FORWARD CURRENT DERATING CURVE

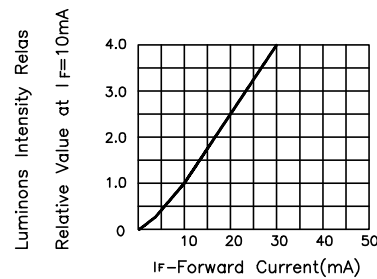

LUMINOUS INTENSITY Vs. FORWARD CURRENT

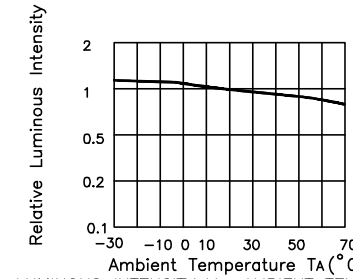

LUMINOUS INTENSITY Vs. AMBIENT TEMPERATURE

Yellow

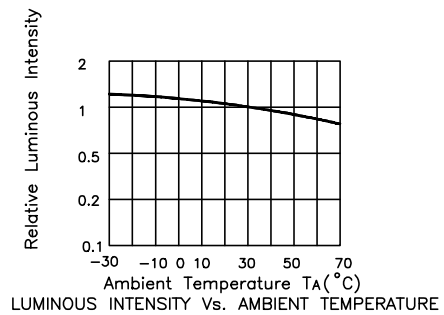
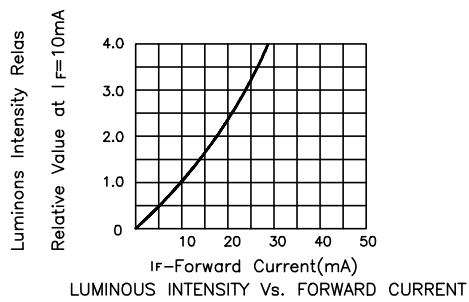
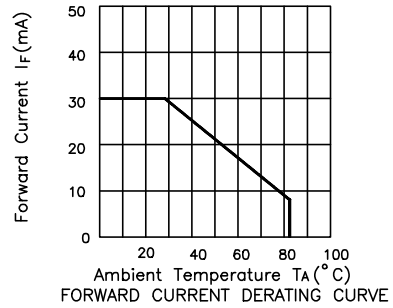
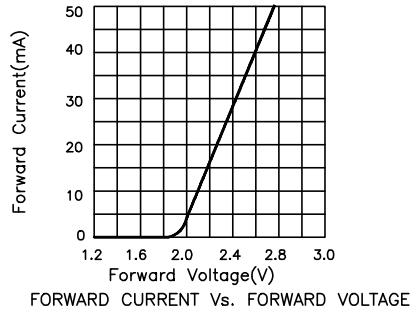

Super Bright Red

