

Reflective Object Sensor

Model No: LBR-132

Features

- Fast response time
- High analytic
- High sensitivity

Applications

- Copiers, Scanners
- Non-Contact switching

Outline Dimensions

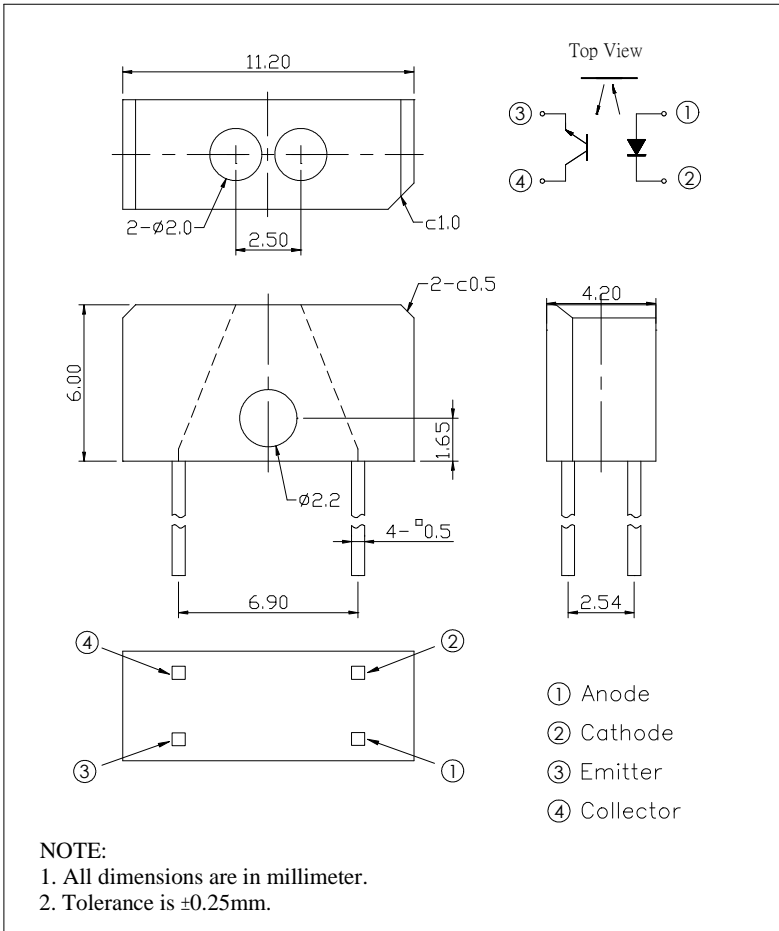

Reflective Object Sensor

Model No: LBR-132

Absolute Maximum Ratings (Ambient Temperature: 25°C)

Item		Symbol	Rating	Units	Note
Input	Forward current	I _F	50	mA	
	Reverse voltage	V _R	5	V	
	Peak forward current	I _{FP}	1	A	T _w =10 μs, t=10ms
	Power dissipation	P _d	75	mW	
Output	Collector current	I _c	20	mA	
	Collector-Emitter voltage	V _{ceo}	30	V	
	Emitter-Collector voltage	V _{eco}	5	V	
	Collector power dissipation	P _c	100	mW	
Storage Temperature		T _{stg}	-40 to +85	°C	
Operating Temperature		T _{op}	-25 to +85	°C	
Soldering Temperature		T _{sol}	260	°C	5 seconds max.

Electrical Specifications (Ambient Temperature: 25°C)

Item		Symbol	MIN.	TYP.	MAX.	Units	Conditions
Input	Forward voltage	V _F		1.2	1.5	V	I _F =20mA
	Reverse current	I _R			10	μA	V _R =5V
	Peak wavelength	λ _p		940		nm	
	View angle	2θ 1/2		35		deg.	I _F =20mA
Output	Dark current	I _{ceo}			100	nA	V _{ce} =20V
	C-E saturation voltage	V _{ce(sat)}			0.4	μA	I _c =2mA, I _B =0.1mA
Light current		I _{c(on)}	0.1			mA	V _{ce} =5V I _F =20mA
Leakage current		I _{leak}			1	μA	
Speed	Rise Time	t _r		15		μs	V _{ce} =5V I _c =1mA R _L =1KΩ
	Fall Time	t _f		15			

Reflective Object Sensor

Reference Data

Forward current Vs. Ambient temperature

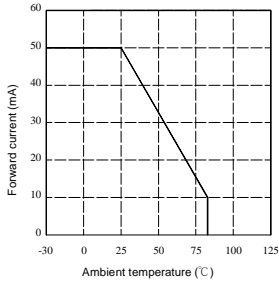

Power dissipation Vs. Ambient temperature

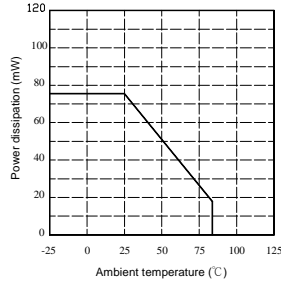

Peak forward current Vs. Duty ratio

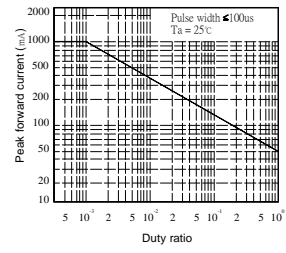

Forward current Vs. Forward voltage

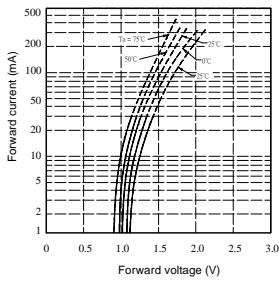

Collector current Vs. Forward current

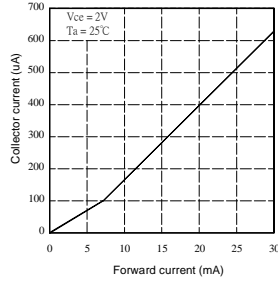

Collector current Vs. Collector-Emitter voltage

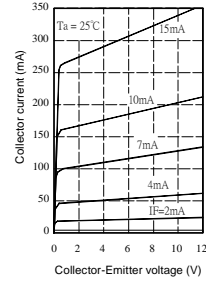

Collector current Vs. Ambient temperature

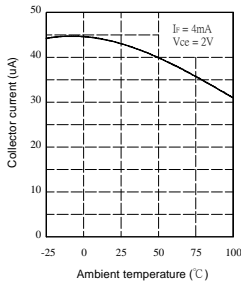

Response time Vs. Load resistance

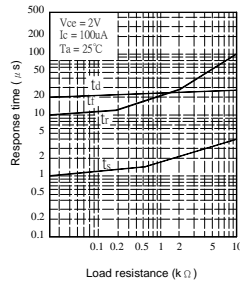

Collector dark current Vs. Ambient temperature

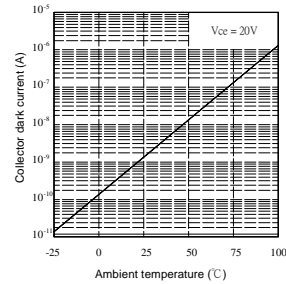

Relative collector current Vs. Card moving distance(1)

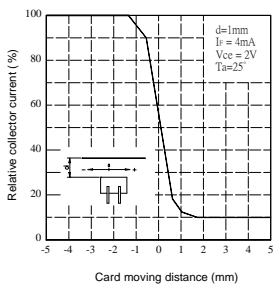

Relative collector current Vs. Card moving distance(2)

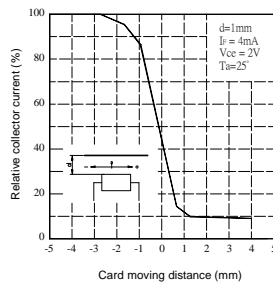

Test circuit for response time

