

## Photo DMOS-FET Relay

### **Description**

The **LT315** is a miniature 2-Form A solid state relay in a 8 pin SOP package that employs optically coupled MOSFET technology to provide 1500V of input to output isolation. The Input of optical coupler been controlled by a highly efficient GaAlAs infrared LED and MOS FETs on the output side.

### **Features**

- SOP package 8 Pin type in miniature design (4.4×9.4×2.0mm / .173×.37×.083inch)
- Low driver power requirements (TTL/CMOS Compatible)
- High reliability
- Arc-Free with no snubbing circuits
- 1500Vrms Input/Output isolation
- Tape & Reel version available

### **Applications**

- Telecommunications (PC, Electronic notepad)
- Measuring and Testing equipment
- Industrial control
- Security equipments
- High speed inspection machine
- Data communication equipment
- Factory automotive equipments

## Photo DMOS-FET Relay Specifications

### Part Name: LT315

(Load voltage: 60V / Load current: 400mA)

#### Absolute Maximum Ratings (Ambient Temperature: 25°C)

Item		Symbol	Value	Units	Note
Input	Continuous LED Current	I <sub>F</sub>	50	mA	
	Peak LED Current	I <sub>FP</sub>	1000	mA	f=100Hz, duty=1%
	LED Reverse Voltage	V <sub>R</sub>	5	V	
	Input Power Dissipation	P <sub>In</sub>	75	mW	
Output	Load Voltage	V <sub>L</sub>	60	V(AC peak or DC)	
	Load Current	I <sub>L</sub>	400	mA	
	Peak Load Current	I <sub>Peak</sub>	1.0	A	100ms(1 pulse)
	Output Power Dissipation	P <sub>out</sub>	400	mW	
Total Power Dissipation		P <sub>T</sub>	450	mW	
I/O Breakdown Voltage		V <sub>I/O</sub>	1500	V <sub>rm</sub>	RH=60%, 1min
Operating Temperature		T <sub>Opr</sub>	-40 to +85	°C	
Storage Temperature		T <sub>Stg</sub>	-40 to +100	°C	
Pin Soldering Temperature		T <sub>Sol</sub>	260	°C	10 sec max.

#### Electrical Specifications (Ambient Temperature: 25°C)

Item		Symbol	MIN.	TYP.	MAX.	Units	Conditions
Input	LED Forward Voltage	V <sub>F</sub>		1.2	1.4	V	I <sub>F</sub> =10mA
	Operation LED Current	I <sub>F On</sub>		0.5	3.0	mA	
	Recovery LED Current	I <sub>F Off</sub>		0.35	0.5	mA	
	Recovery LED Voltage	V <sub>F Off</sub>	0.5			V	
Output	On-Resistance	R <sub>On</sub>		0.8	2.0	Ω	I <sub>F</sub> =5mA, I <sub>L</sub> =100mA, Time to flow is within 1 sec.
	Off-State Leakage Current	I <sub>Leak</sub>			1	μA	V <sub>L</sub> =Rating
	Output Capacitance	C <sub>Out</sub>		115		pF	V <sub>L</sub> =0, f=1MHz
Transmis sion	Turn-On Time	T <sub>On</sub>		0.65	2.0	ms	I <sub>F</sub> =5mA, I <sub>L</sub> =100mA
	Turn-Off Time	T <sub>Off</sub>		0.08	0.2	ms	
Coupled	I/O Isolation Resistance	R <sub>I/O</sub>	10 <sup>9</sup>			Ω	DC500V
	I/O Capacitance	C <sub>I/O</sub>		0.8	1.5	pF	f=1MHz

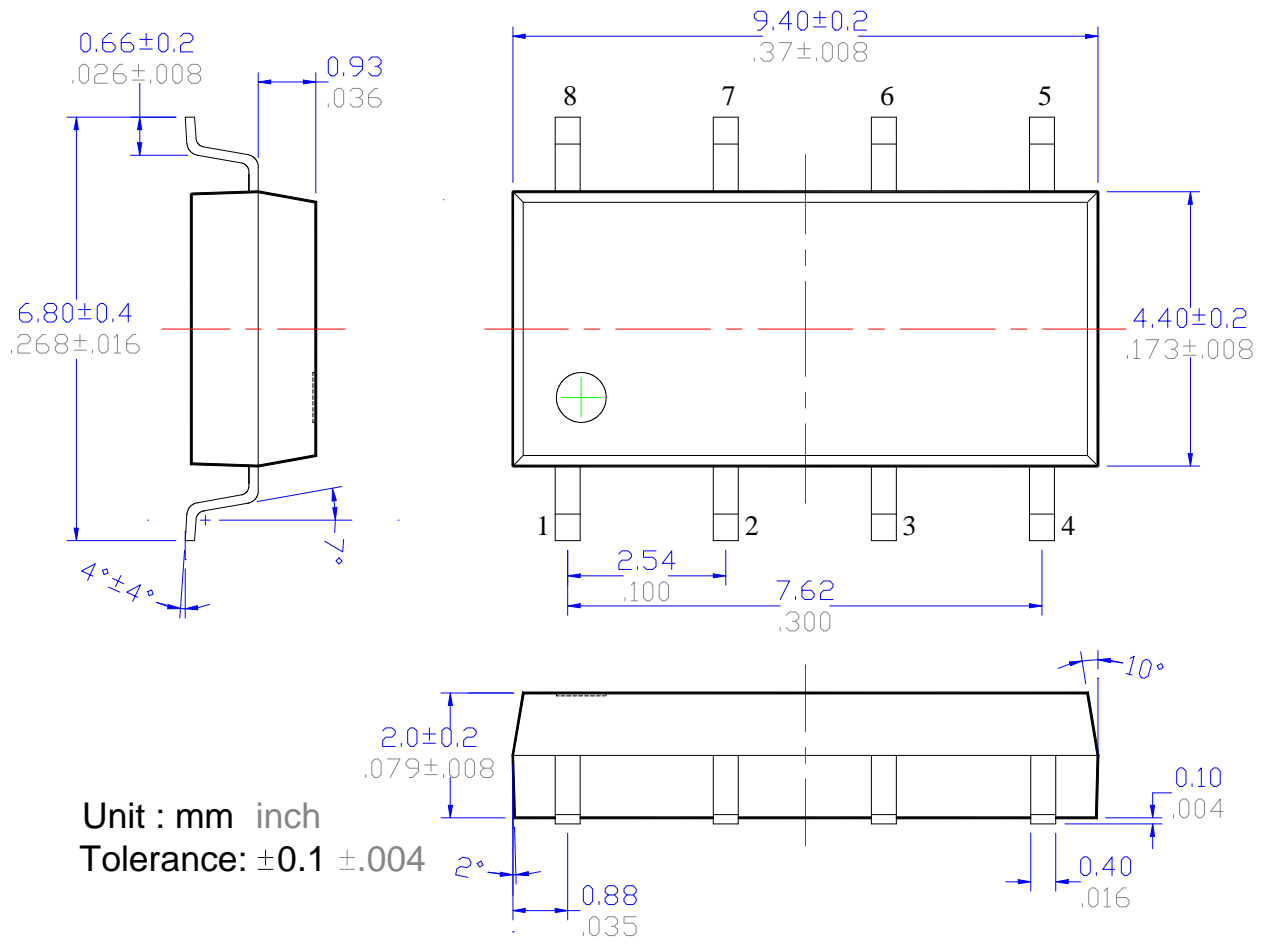

### Schematic

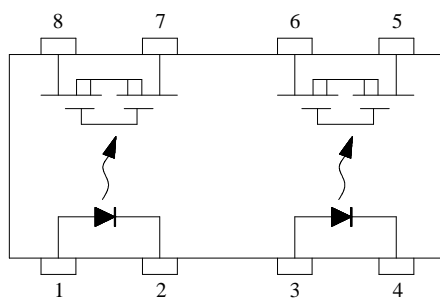

- 1,3. LED Anode
- 2,4. LED Cathode
- 5,6,7,8. MOS FET

Load current Vs. Ambient temperature

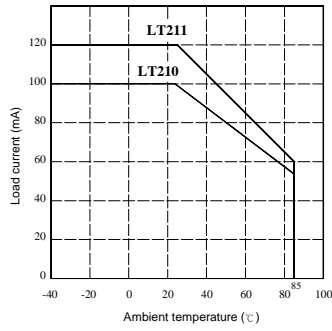

On resistance Vs. Ambient temperature

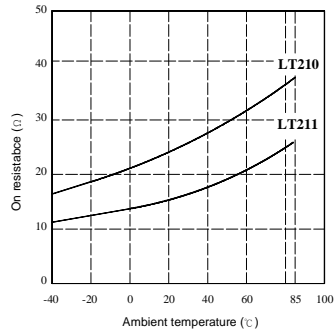

Turn on time Vs. Ambient temperature

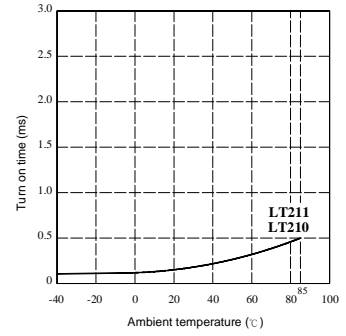

Turn off time Vs. Ambient temperature

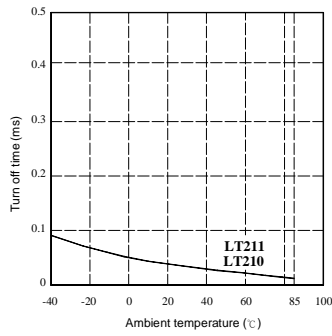

LED operate current Vs. Ambient temperature

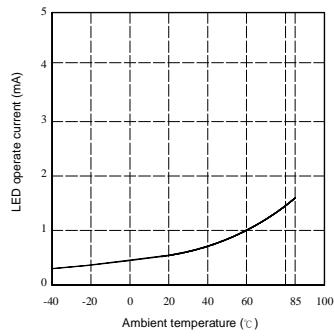

LED turn off current Vs. Ambient temperature

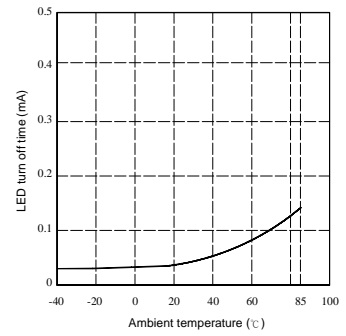

LED forward voltage Vs. Ambient temperature

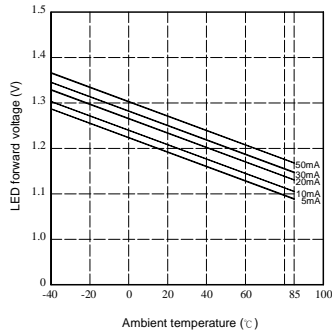

Voltage Vs. current characteristics of output at MOS portion

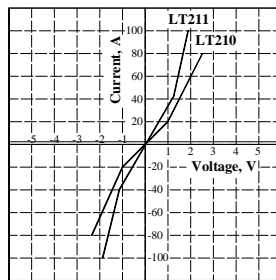

Off state leakage current

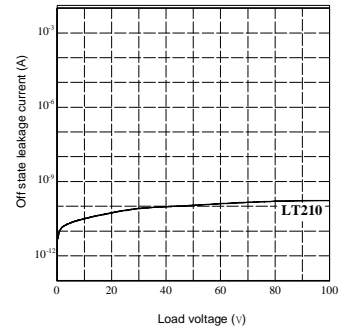

LED forward current Vs. turn on time characteristics

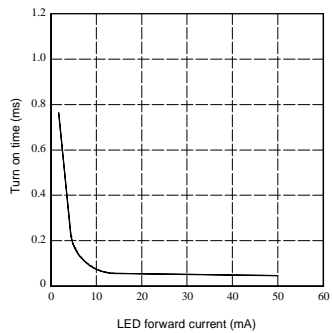

LED forward current Vs. turn off time characteristics

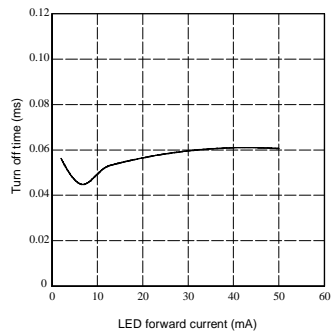

Applied voltage Vs. output capacitance characteristics

