

FEATURES

- *Guaranteed* Max Input Offset Voltage 1.0mV
- *Guaranteed* Max Input Offset Current 5nA
- *Guaranteed* Max Response Time 250ns
- *Guaranteed* Min. Voltage Gain 200,000
- $\pm 30V$ Differential Input Voltage
- Drives 50mA Loads At Up To 50V.
- $\frac{1}{2}$ The Power Dissipation For LT111A/LT311A

APPLICATIONS

- General Purpose Comparator
- Zero Crossing Detector
- Voltage To Frequency Converter

DESCRIPTION

The LT111A is an improved version of the LM111 general purpose comparator. These new devices offer maximum input offset voltage of 1.0mV and input offset current of 5.0nA with a maximum response time of 250ns. The LT111A operates from a single 5V supply to $\pm 15V$ supplies and can drive up to 50mA loads referred to ground or either supply. A separate output ground pin allows output signals to be isolated from analog ground.

The versatility of the LT111A is enhanced by an input stage design which allows differential input signals of up to $\pm 30V$. Offset balancing, strobe capability and the ability to "OR" the output is also included. These features plus Linear Technology Corporation's advanced processing and reliability enhancements make the LT111A an ideal choice for most comparator applications. For higher performance requirements, see the LT1011. For operation up to 200°C, see LT111X data sheet.

Low Drift R/C Oscillator

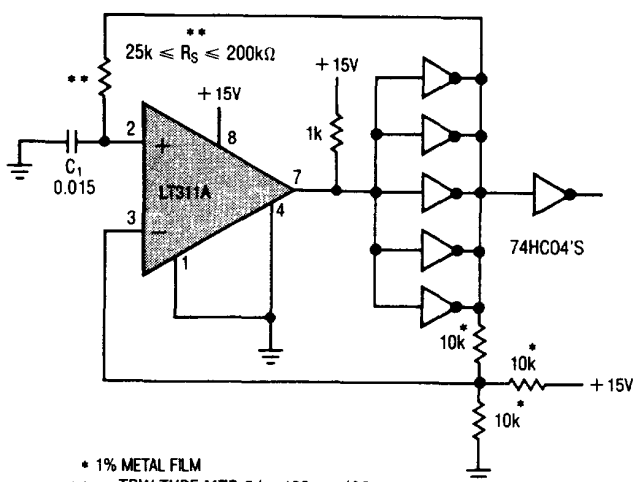

* 1% METAL FILM
 ** = TRW TYPE MTR-5/ +120ppm/°C.
 C₁ = .015 = POLYSTYRENE - 120ppm/°C ± 30ppm WESCO TYPE 32-P
 NOTE: COMPARATOR CONTRIBUTES $\leq 10\text{ppm}/^\circ\text{C}$ DRIFT FOR FREQUENCIES BELOW 10kHz.

Transfer Function

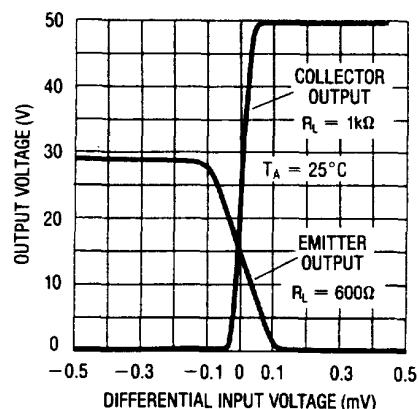

LT111A/LT311A LM111/LM311

ABSOLUTE MAXIMUM RATINGS

Supply Voltage (pin 8 to pin 4)	36V
Output to Negative Supply (pin 7 to pin 4)	
LT111A/LM111	50V
LT311A/LM311	40V
Ground to Negative Supply (pin 1 to pin 4)	30V
Differential Input Voltage	±30V
Voltage at Strobe Pin (pin 6 to pin 8)	5V
Input Voltage (Note 1)	±15V
Output Short Circuit Duration	10 sec.
Operating Temperature Range (Note 2)	
LT111A/LM111	-55°C to 125°C
LT311A/LM311	0°C to 70°C
Storage Temperature Range	-65°C to 150°C
Lead Temperature (Soldering, 10 sec.)	300°C

PACKAGE/ORDER INFORMATION

<p>H PACKAGE TO-5 METAL CAN</p>	ORDER PART NUMBER LT111AH LM111H LT311AH LM311H
<p>TOP VIEW</p> <p>NOTE: PIN 4 CONNECTED TO CASE. J8 PACKAGE 8 PIN CERDIP N8 PACKAGE 8 PIN PLASTIC</p>	LT111AJ8 LM111J8 LT311AJ8 LM311J8 LT311AN8 LM311N8

ELECTRICAL CHARACTERISTICS $V_S = \pm 15V$, $T_A = 25^\circ C$ unless otherwise noted.

SYMBOL	PARAMETER	CONDITIONS	LT 111A			LM 111			UNITS	
			MIN	TYP	MAX	MIN	TYP	MAX		
V_{OS}	Input Offset Voltage	$R_S \leq 50k$ (Note 3, 4)	●	0.5	1.0 2.0		0.7	3.0 4.0	mV	
I_{OS}	Input Offset Current	(Note 3,4)	●	2.0	5.0 10.0		4.0	10.0 20.0	nA	
I_B	Input Bias Current	Note 3	●	60	100 150		60	100 150	nA	
A_{VOL}	Large Signal Voltage Gain	Note 7		200	500		40	200	V/mV	
	Response Time	Note 5		200	250		200		nS	
	Saturation Voltage	$V_{IN} \leq -5mV$, $I_{OUT} = 50mA$ $V_+ \geq 4.5V$, $V_- = 0$ $V_{IN} \leq -6mV$, $I_{SNK} \leq 8mA$	●	0.75	1.5		0.75	1.5	V	
	Strobe ON Current	Note 6		3.0	4.0		3.0		mA	
	Output Leakage Current	$V_{IN} \geq 5mV$, $V_{OUT} = 35V$ $I_{STROBE} = 3mA$	●	0.2	10.0		0.2	10.0	nA	
				0.1	0.5		0.1	0.5	μA	
	Input Voltage Range	$V_+ = 15V$, $V_- = 15V$ Pin 7 Pull up may go to 5V	●	-14.5	{ 13.8 } { -14.7 }	13.0	-14.5	{ 13.8 } { -14.7 }	13.0	V
	Positive Supply Current			3.0	4.0		5.1	6.0	mA	
	Negative Supply Current			1.5	2.5		4.1	5.0	mA	

Shading of a specification highlights those items which offer key improvements in parametric performance or guaranteed test limits provided for the first time.

ELECTRICAL CHARACTERISTICS $V_S = \pm 15V$, $T_A = 25^\circ C$ unless otherwise noted.

SYMBOL	PARAMETER	CONDITIONS	LT 311A			LM311			UNITS	
			MIN	TYP	MAX	MIN	TYP	MAX		
V_{OS}	Input Offset Voltage	$R_S \leq 50k$ (Note 3, 4)	●	0.5	1.0 2.0	2.0	7.5 10	mV		
I_{OS}	Input Offset Current	(Note 3,4)	●	2.0	10 20	6.0	50 70	nA		
I_B	Input Bias Current	Note 3		60	100 150	100	250 300	nA		
A_{VOL}	Large Signal Voltage Gain			200	500	40	200	V/mV		
	Response Time	Note 5		200	250	200		nS		
	Saturation Voltage	$V_{IN} \leq -10mV$, $I_{OUT} = 50mA$ $V_+ \geq 4.5V$, $V_- = 0$ $V_{IN} \leq -10mV$, $I_{SINK} \leq 8mA$		0.75	1.5	0.75	1.5	V		
			●	0.23	0.4	0.23	0.4	V		
	Strobe ON Current	Note 6		3.0	4.0	3.0		mA		
	Output Leakage Current	$V_{IN} \geq 10mV$, $V_{OUT} = 35V$ $I_{STROBE} = 3mA$		0.2	50	0.2	50	nA		
			●	0.1	0.5			μA		
	Input Voltage Range		●	-14.5	{ 13.8 } { -14.7 }	13.0	-14.5	{ 13.8 } { -14.7 }	13.0	V
	Positive Supply Current			3.0	4.0	5.1	7.5	mA		
	Negative Supply Current			1.5	2.5	4.1	5.0	mA		

The ● denotes the specifications which apply over the full operating temperature range.

Note 1: Applicable for $\pm 15V$ supplies. The positive input voltage limit is 30V above the negative supply. The negative input voltage limit is the negative supply.

Note 2: T_j max. = $150^\circ C$ for the LT111A and $95^\circ C$ for the LT311A.

Note 3: Offset voltage, offset current and bias current specifications apply for any supply voltage from a single 5V up to $\pm 15V$ supplies.

Note 4: Offset voltages and offset currents shown are the maximum values required to drive the output within a volt of either supply with a 1mA load. These parameters define an error band and take into account the worst case effects of voltage gain and input impedance.

Note 5: Response time is specified for a 100mV input step with 5mV overdrive with the collector output terminated with a 500 Ω pullup resistor tied to 5V.

Note 6: Do not short the strobe pin to ground. It should be current driven at 3 to 5mA for the shortest strobe time. Currents as low as 500 μA will strobe the LT111A if speed is not important. External leakage on the strobe pin in excess of 0.2 μA when the strobe is "off" can cause offset voltage shifts.

Note 7: $R_L = 1k\Omega$, $-10V \leq V_{OUT} \leq 14.5V$

TYPICAL PERFORMANCE CHARACTERISTICS

Input Bias Current

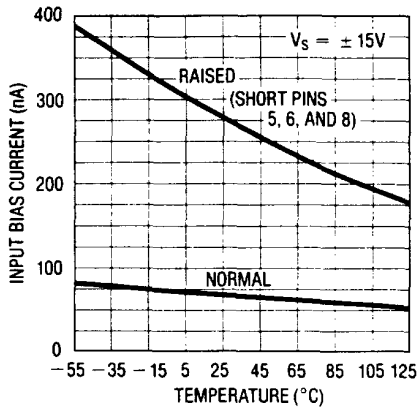

Input Offset Current

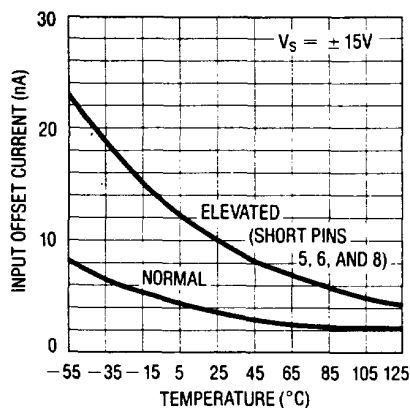

Offset Error

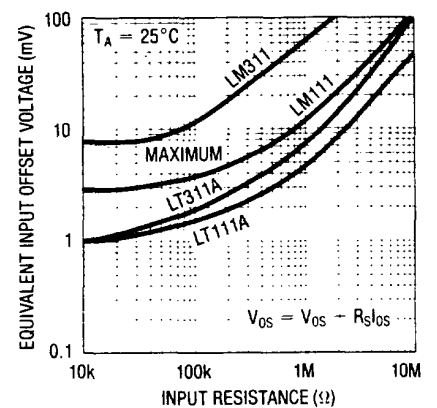

Input Characteristics

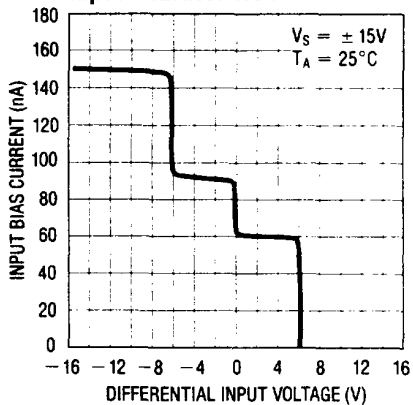

Common Mode Limits

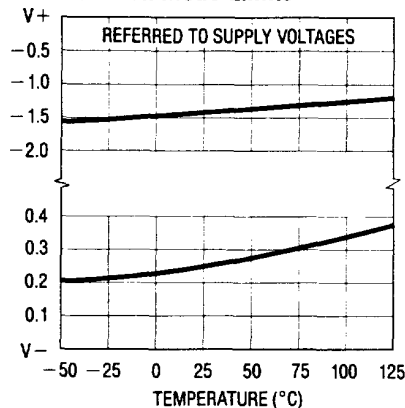

Transfer Function

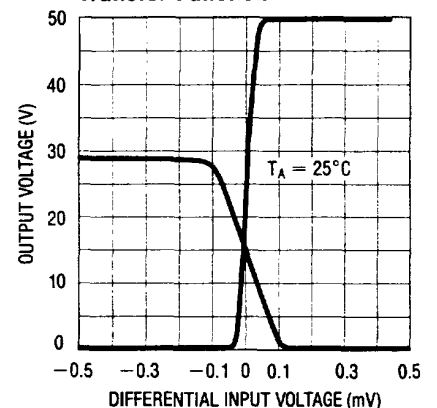

Response Time for Various Input Overdrives

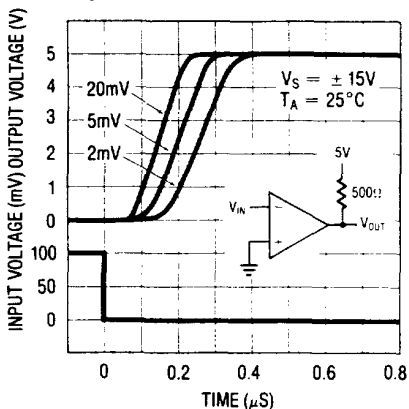

Response Time for Various Input Overdrives

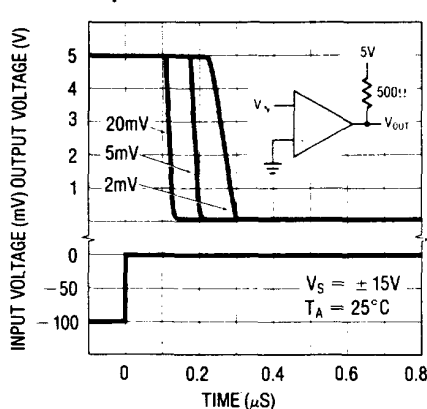

Collector Output Saturation Voltage

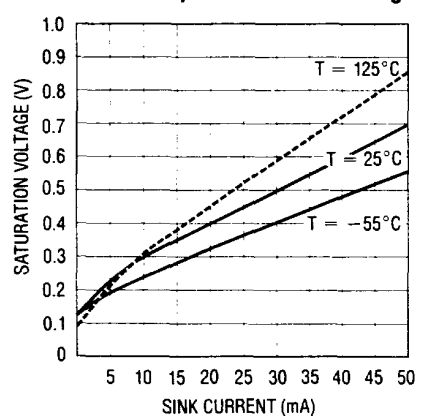

TYPICAL PERFORMANCE CHARACTERISTICS

Response Time Using GND Pin as Output

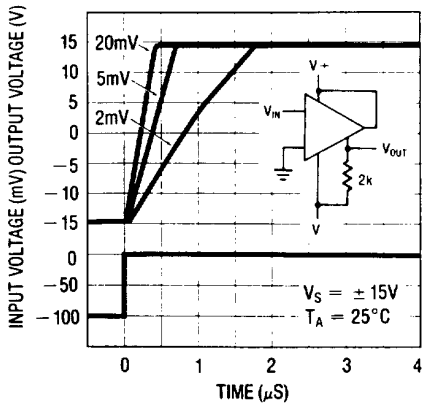

Response Time Using GND Pin as Output

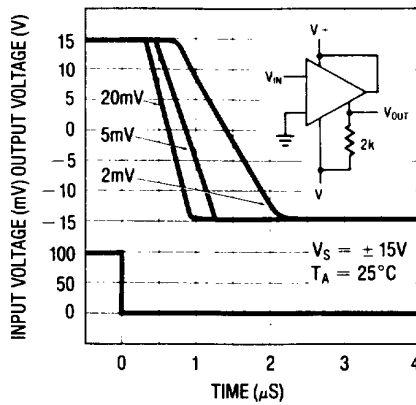

Output Limiting Characteristics

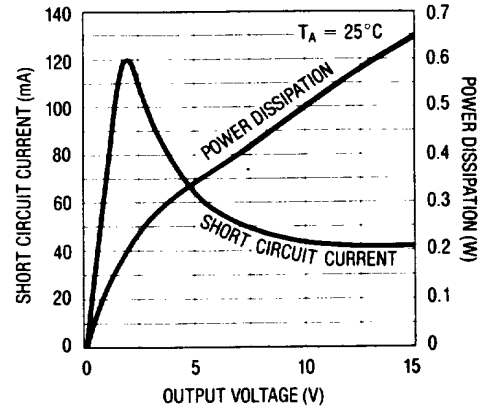

Supply Current vs Supply Voltage

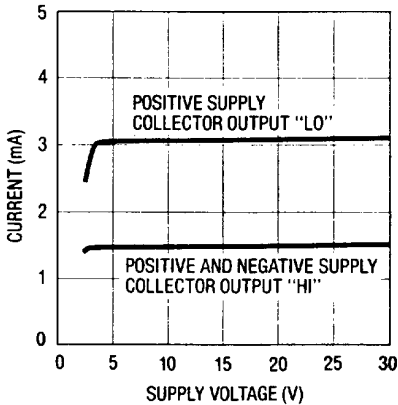

Supply Current vs Temperature

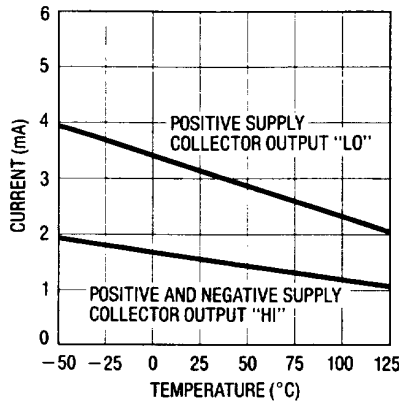

Leakage Current vs Temperature

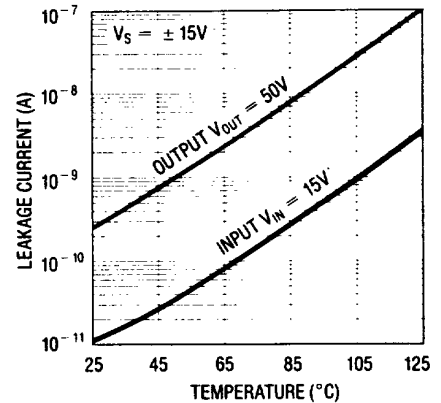

6

TYPICAL APPLICATIONS

Offset Balancing

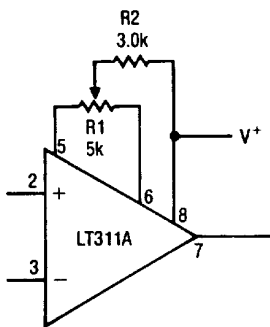

Note: Pin Connections Shown are for T0-5 package

Strobing

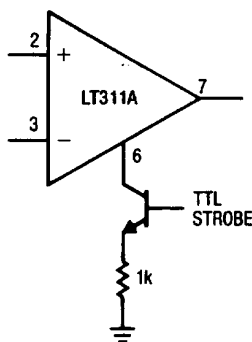

Note: Do Not Ground Strobe Pin.

Increasing Input Stage Current

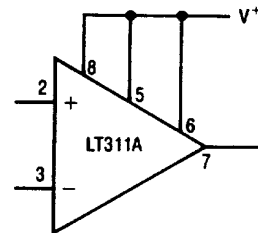

Increases typical common mode slew rate from 7.0 V/ μ S to 18V/ μ S.

TYPICAL APPLICATIONS

**Driving Load Referenced
To Positive Supply**

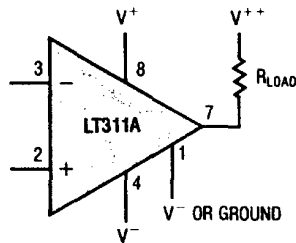

V^{++} CAN BE GREATER OR LESS THAN V^+

**Driving Load Referenced
To Negative Supply**

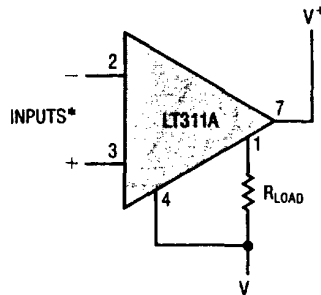

* NOTE THAT INPUT
POLARITY IS REVERSED
WHEN USING PIN 1 AS
OUTPUT

Driving Ground Referred Load

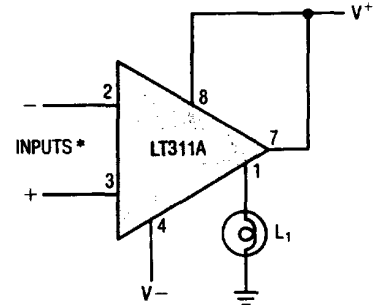

* NOTE THAT INPUT
POLARITY IS REVERSED
WHEN USING PIN 1 AS
OUTPUT

Window Detector

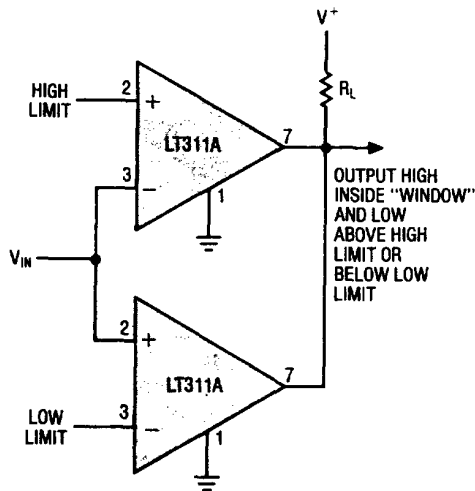

Using Clamp Diodes To Improve Frequency Response*

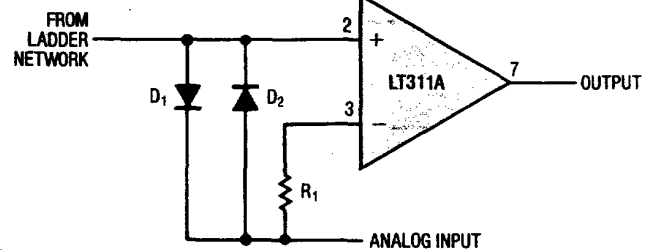

* RESPONSE TIME
INCREASES TO $\approx 500\text{nS}$
IF INPUT MUST SLEW 5V
TO REACH THRESHOLD.

Crystal Oscillator

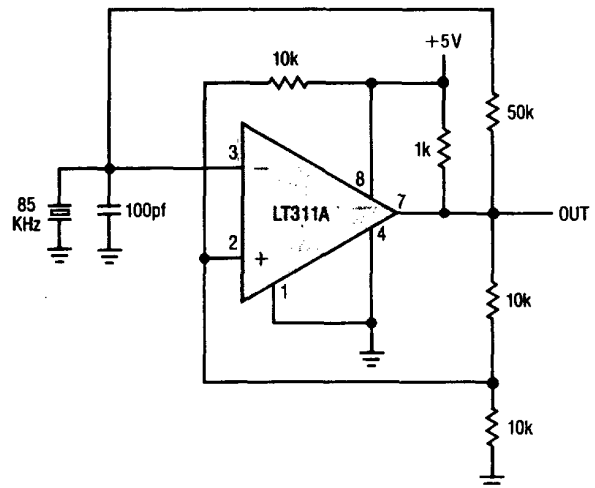

Detector For Magnetic Transducer

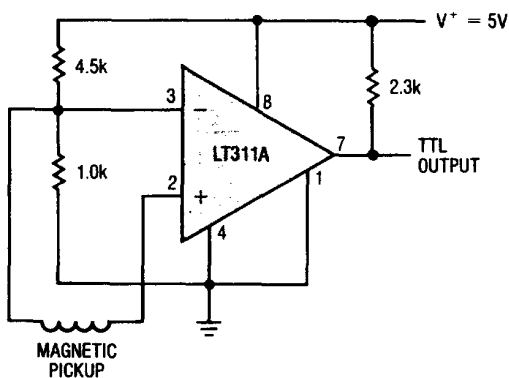

Low Drift R/C Oscillator

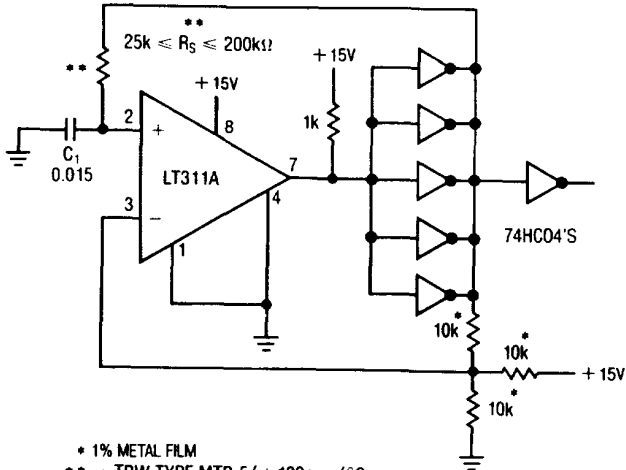

* 1% METAL FILM
 ** = TRW TYPE MTR-5/ +120ppm/°C.
 C₁ = .015 = POLYSTYRENE - 120ppm/°C ± 30ppm WESCO TYPE 32-P
 NOTE: COMPARTOR CONTRIBUTES ≤ 10ppm/°C DRIFT FOR FREQUENCIES BELOW 10kHz.

Strobing Off Both Input* And Output Stages

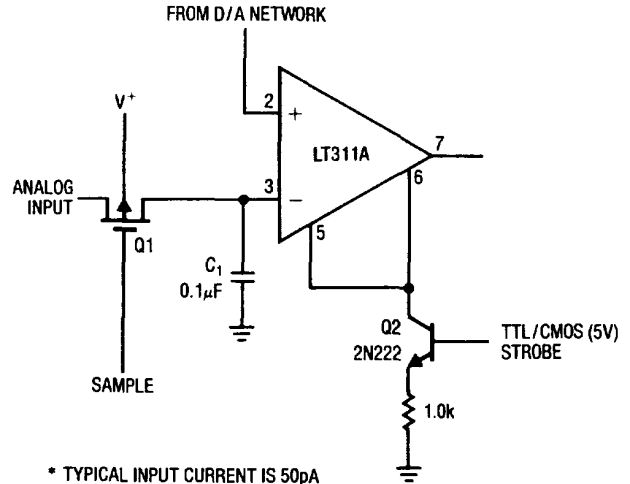

* TYPICAL INPUT CURRENT IS 50pA WITH INPUTS STROBED OFF. DO NOT GROUND STROBE PIN

Positive Peak Detector

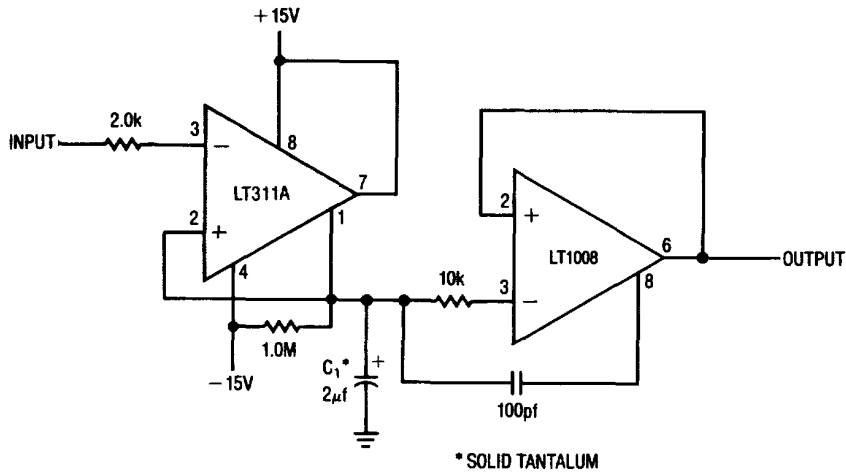

* SOLID TANTALUM

Negative Peak Detector

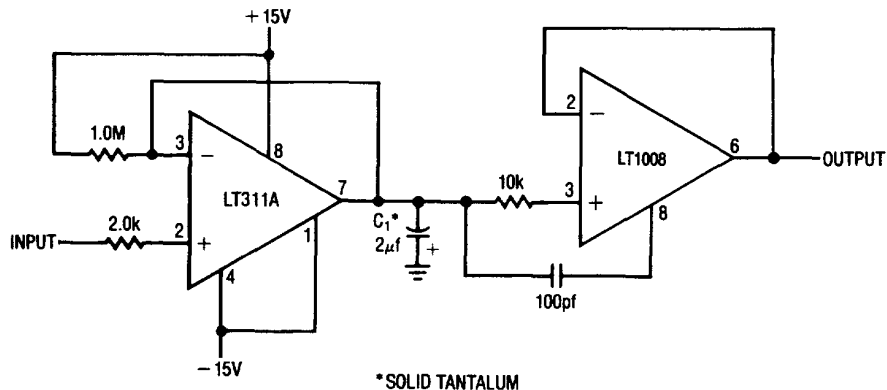

* SOLID TANTALUM

6

SCHEMATIC DIAGRAM

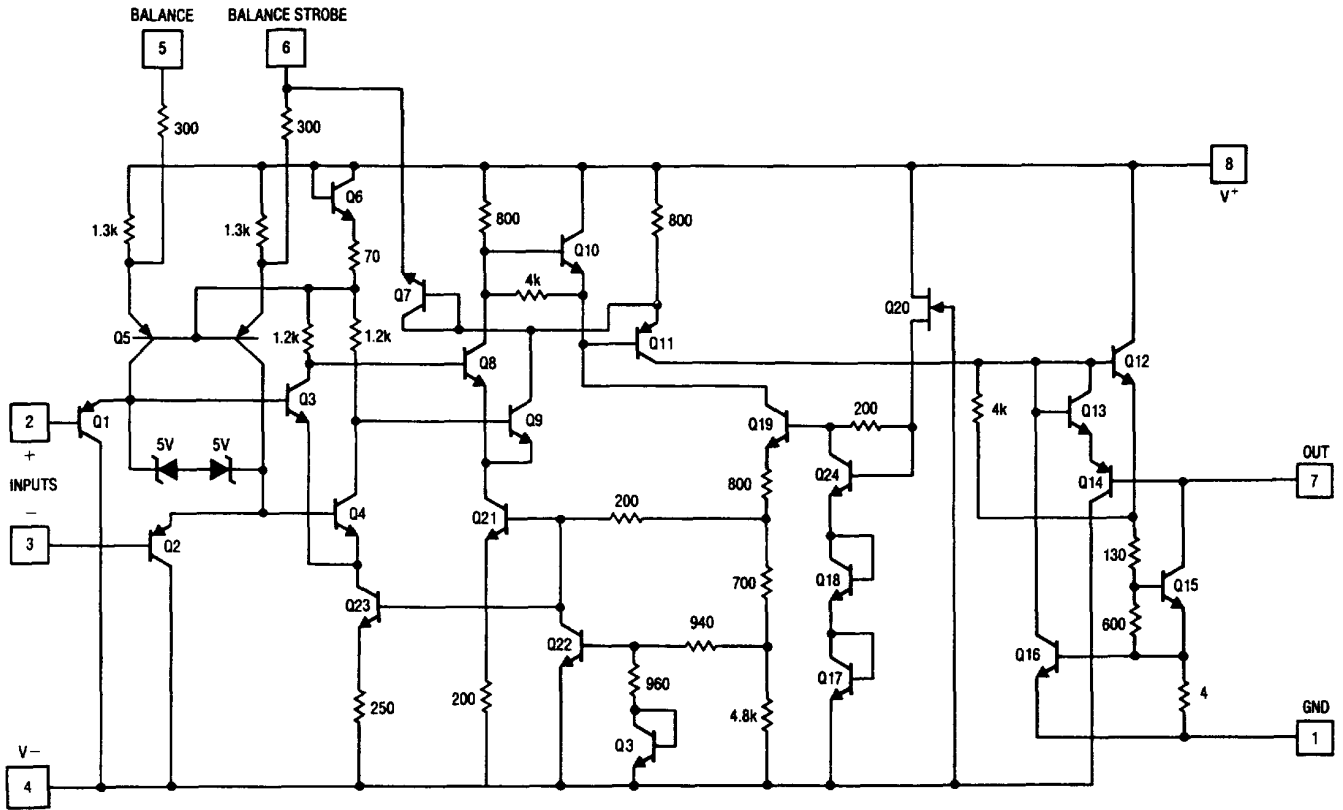

PACKAGE DESCRIPTION

Dimensions in inches (millimeters) unless otherwise noted.

H Package
Metal Can

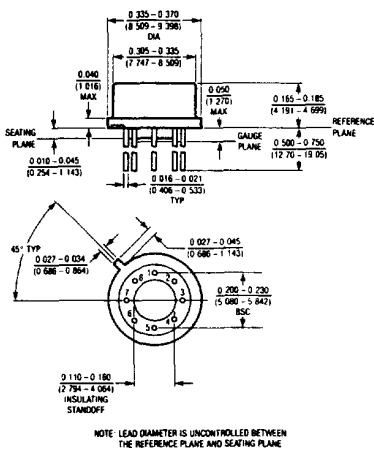

T_j max	θ_{ja}	θ_{jc}
150°C	150°C/W	45°C/W

J8 Package
8 Lead Hermetic Dip

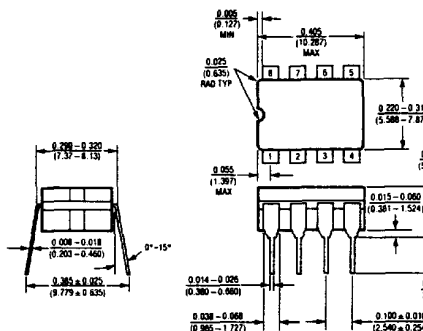

T_j max	θ_{ja}
150°C	100°C/W

N8 Package
8 Lead Plastic

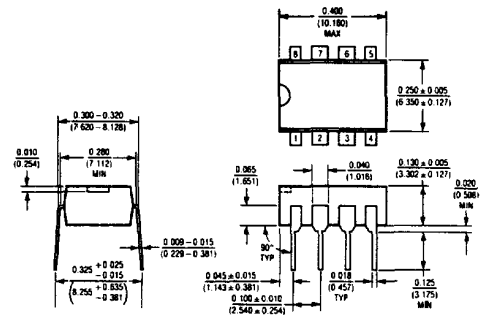

T_j max	θ_{ja}
100°C	130°C/W