

## FEATURES

- Maximum Offset Voltage 1mV
- Maximum Bias Current 15nA
- Typical Output Drive 70mA
- Operates from 1.1V to 40V
- Internal Pull-Up Current
- Output Can Drive Loads Above  $V^+$
- 30 $\mu$ A Supply Current (LT1017)
- 110 $\mu$ A Supply Current (LT1018)

## APPLICATIONS

- Power Supply Monitors
- Relay Driving
- Oscillators

## DESCRIPTION

The LT1017 and LT1018 are general purpose micropower comparators. The LT1017 is optimized for lowest operating power while the LT1018 operates at higher power and higher speed. Both devices can operate from a single 1.1V cell up to 40V. The output stage includes a class "B" pull-up current source, eliminating the need for an external resistive pull-up and saving power. The output stage is also designed to allow driving loads connected to a supply more positive than the device, as can comparators with open collector output stages.

Input specifications are also excellent. On-chip trimming minimizes offset voltage, while high gain and common-mode rejection ratio keep other input-referred errors low. Common-mode voltage range includes ground. Special circuitry prevents false output states even if the input is overdriven.

The LT1017 and LT1018 are pin compatible with older dual comparators such as 393 type devices.

### 1.5V Powered Refrigerator Alarm

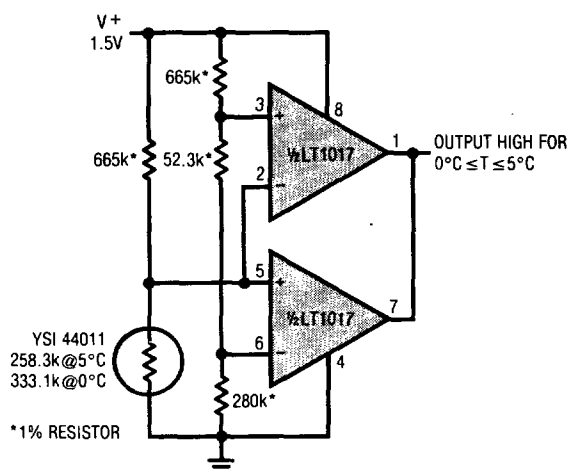

### Supply Current

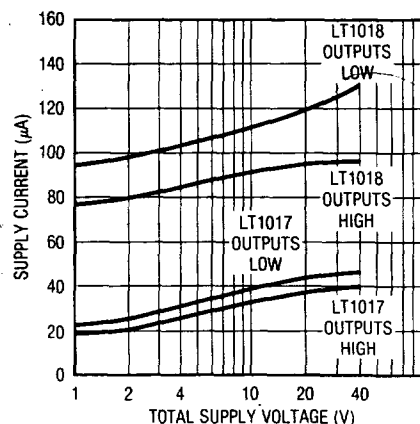

## ABSOLUTE MAXIMUM RATINGS

Supply Voltage ..... 40V  
 Differential Input Voltage ..... 40V  
 Input Voltage ..... -0.3V to 40V  
 Short Circuit Duration ..... Indefinite  
 Storage Temperature Range ..... -65°C to 150°C

Operating Temperature Range  
 LT1017M, LT1018M ..... -55°C to 125°C  
 LT1017C, LT1018C ..... 0°C to 70°C  
 LT1017I, LT1018I ..... -40°C to 85°C  
 Lead Temperature (Soldering, 10 sec) ..... 300°C

## PACKAGE/ORDER INFORMATION

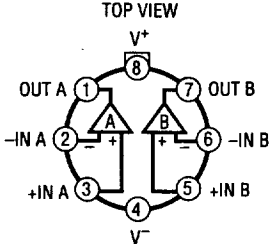
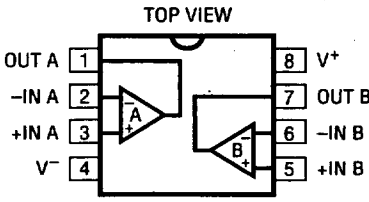
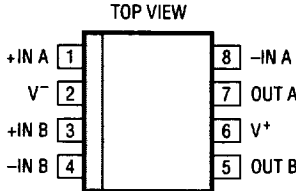
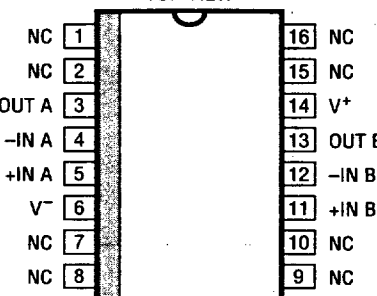
 <p>H PACKAGE 8-LEAD TO-5 METAL CAN</p> <p><math>T_{JMAX} = 150^{\circ}\text{C}</math>, <math>\theta_{JA} = 150^{\circ}\text{C/W}</math>, <math>\theta_{JC} = 45^{\circ}\text{C/W}</math></p>	<p>ORDER PART NUMBER</p> <p>LT1017MH LT1017CH LT1018MH LT1018CH</p>	 <p>N8 PACKAGE 8-LEAD PLASTIC DIP</p> <p><math>T_{JMAX} = 100^{\circ}\text{C}</math>, <math>\theta_{JA} = 130^{\circ}\text{C/W}</math></p>	<p>ORDER PART NUMBER</p> <p>LT1017CN8 LT1018CN8</p>
 <p>S8 PACKAGE 8-LEAD PLASTIC SO (0.150" BODY WIDTH)</p> <p>NOTE: PINOUT ON S8 PACKAGE DOES NOT MATCH 8 PIN DIP PINOUT.</p> <p><math>T_{JMAX} = 100^{\circ}\text{C}</math>, <math>\theta_{JA} = 190^{\circ}\text{C/W}</math></p>	<p>ORDER PART NUMBER</p> <p>LT1017CS8 LT1017IS8 LT1018CS8</p>	 <p>S PACKAGE 16-LEAD PLASTIC SOL</p> <p><math>T_{JMAX} = 100^{\circ}\text{C}</math>, <math>\theta_{JA} = 130^{\circ}\text{C/W}</math></p>	<p>ORDER PART NUMBER</p> <p>LT1017CS8 LT1017CS LT1018CS LT1017IS LT1017IS8</p> <p>PART MARKING</p> <p>1017CS 1018CS 1017IS</p>

10

## ELECTRICAL CHARACTERISTICS

PARAMETER	CONDITIONS	LT1017			LT1018			UNITS
		MIN	TYP	MAX	MIN	TYP	MAX	
Offset Voltage (Note 1)	$\pm 0.75\text{V} \leq V_S \leq \pm 20\text{V}$	25°C	0.4	1	0.4	1	mV	
		●	0.5	1.4	0.5	1.4	mV	
		125°C		1.5	0.7	1.5	mV	
Bias Current	$\pm 0.75\text{V} \leq V_S \leq \pm 20\text{V}$	25°C	5	15	15	75	nA	
		●	7	25	18	100	nA	
		125°C	10	40		110	nA	
Offset Current	$\pm 0.75\text{V} \leq V_S \leq \pm 20\text{V}$	25°C	0.4	2	1	8	nA	
		●	0.5	3	1.6	12	nA	
		125°C		12		20	nA	

**ELECTRICAL CHARACTERISTICS**

PARAMETER	CONDITIONS		LT1017			LT1018			UNITS
			MIN	TYP	MAX	MIN	TYP	MAX	
Common-Mode Rejection Ratio	$V_S = \pm 20V, -20V \leq V_{CM} \leq 19.1V$	25°C	105	115		105	115	dB	
		●	100	115		100	115	dB	
		125°C	86	100		95	110	dB	
Power Supply Rejection Ratio	$\pm 0.75V \leq V_S \leq \pm 20V$	25°C	96	110		96	110	dB	
		●	95	105		95	105	dB	
		125°C	86			86	100	dB	
Gain	No Load, $V_{OUT} = \pm 19.9V$ (Note 2)	25°C	110	115		110	125	dB	
		●	105	115		105	120	dB	
		125°C	100			100		dB	
		25°C	100	110		100	110	dB	
		●	94			94		dB	
Output Sink Current	$V^+ = 4.5V, V^- = 0$ Overdrive > 30mV	25°C	30	65		35	70	mA	
		●	25	50		25	50	mA	
		125°C	10	20		10	30	mA	
Output Source Current	$V^+ = 40V, V^- = 0$ $V_{IN} = 5mV, V_{OUT} = 0.4V$	25°C	30	75		75	250	μA	
		●	25	70		50	220	μA	
		125°C	25	75		50	200	μA	
Output Source Current	$V^+ = 1.2V, V^- = 0$ $V_{IN} = 5mV, V_{OUT} = 0.4V$	25°C	25	35		70	140	μA	
		●	15	20		45	120	μA	
		125°C	25	40		40	110	μA	
Negative Output Saturation	$I_{OUT} = 0$ $V^+ = 4.5V, V^- = 0$ $V_{IN} = -10mV$	25°C		5	20		5	15	mV
		●		35	60		35	60	mV
		25°C		60	120		60	120	mV
		●		120	200		120	250	mV
		25°C		350	600		350	700	mV
		●		5	20		8	20	mV
		25°C		40	75		35	70	mV
		●		75	150		70	150	mV
		25°C		150	300		150	300	mV
		●		600	900		500	900	mV
		125°C		25	50		10	40	mV
		●		60	100		60	100	mV
		125°C		100	200		110	200	mV
		●		300	600		300	400	mV
		125°C					900		mV
Positive Output Saturation	$I_{OUT} = 0$ $= 10\mu A$ $= 0$ $= 10\mu A$ $= 0$ $= 10\mu A$	25°C		40	80		35	80	mV
		●		175	250		175	250	mV
		25°C		45	90		45	90	mV
		●		190	300		190	300	mV
		125°C		50	100		50	100	mV
		●			300			300	mV
Leakage Current	$V_S = 5V, V_{OUT} = 40V$ $V_{IN} = 100mV$	25°C		0.5	3		1	8	μA
		●		0.6	3		1.8	10	μA
		125°C			5			15	μA
Supply Current	$V_S = 5V$	25°C		30	60		110	250	μA
		●		40	80		110	250	μA
		125°C			80			300	μA
	$V_S = 40V$	25°C		40	90		130	250	μA
		●		55	100		140	270	μA
		125°C			100			300	μA
Minimum Operating Voltage	$I_{OUT} = 1mA$	25°C			1.15		1.2	V	
		●			1.15		1.2	V	
		125°C			1.15		1.2	V	

The ● denotes specifications which apply over operating temperature range of -55°C to 85°C for M grade parts and 0°C to 70°C for C grade parts.

**Note 1:** Offset voltage is guaranteed over a common-mode voltage range of  $V^- \leq V_{IN} \leq (V^+ - 0.9V)$ .

**Note 2:** No load gain is guaranteed but not tested (LT1017 only).

# TYPICAL PERFORMANCE CHARACTERISTICS

**Input Bias Current**

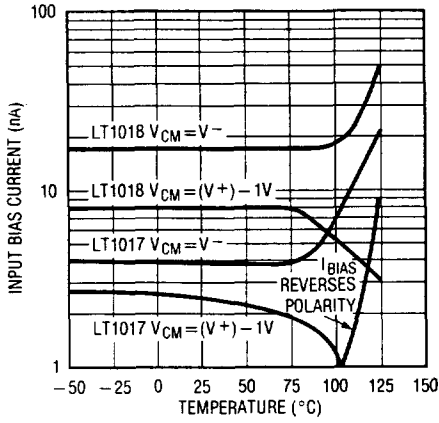

**Input Offset Current**

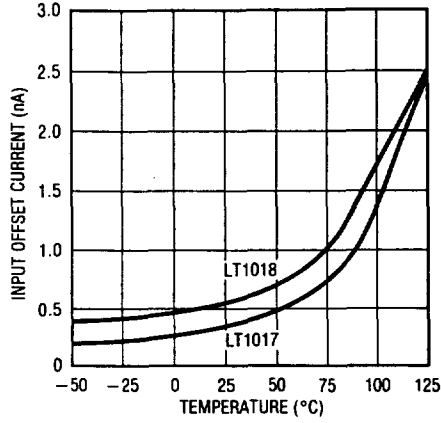

**Bias Current vs Differential Input**

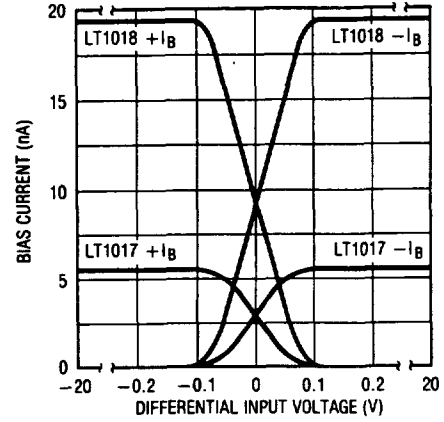

**Input Bias Current with Inputs Driven Below the Supply**

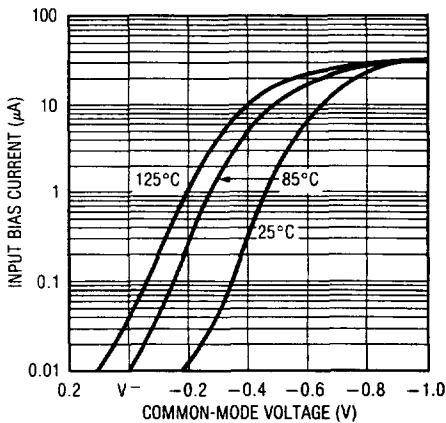

**Common-Mode Limits**

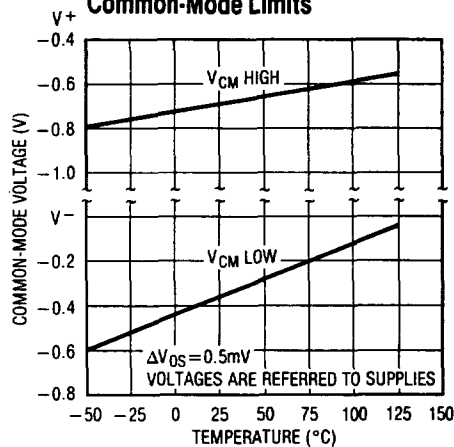

**Supply Current**

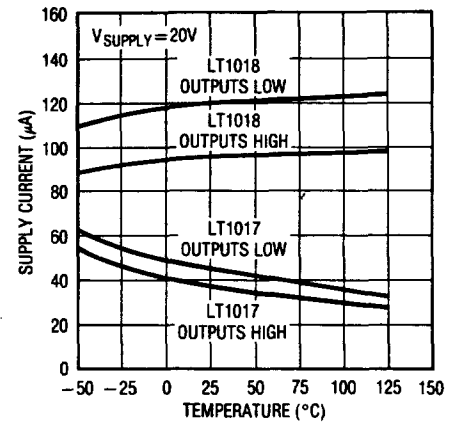

**Positive Supply Current**

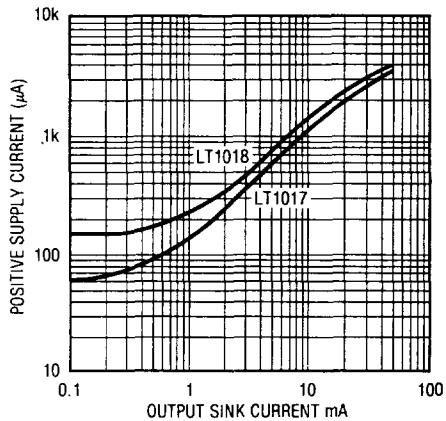

**NPN Output Saturation Voltage**

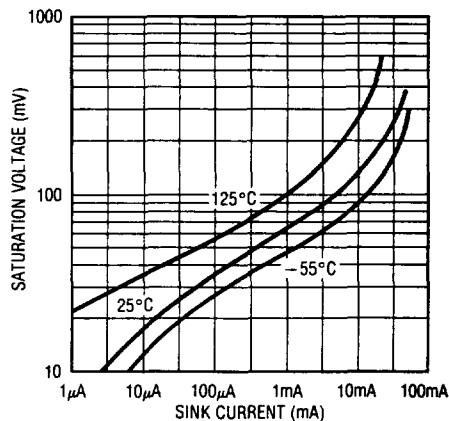

**Output Sinking Current Limit**

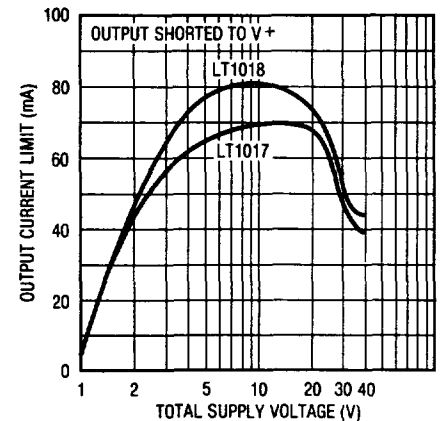

10

# TYPICAL PERFORMANCE CHARACTERISTICS

**Output Sinking Current Limit**

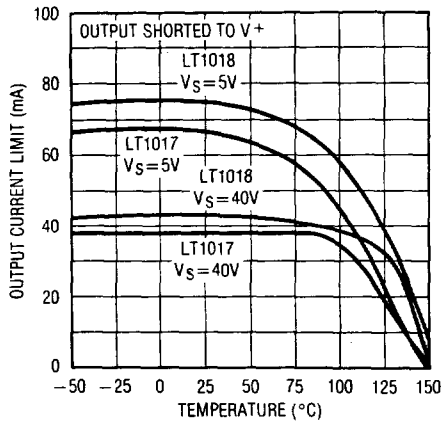

**Total Switching Time**

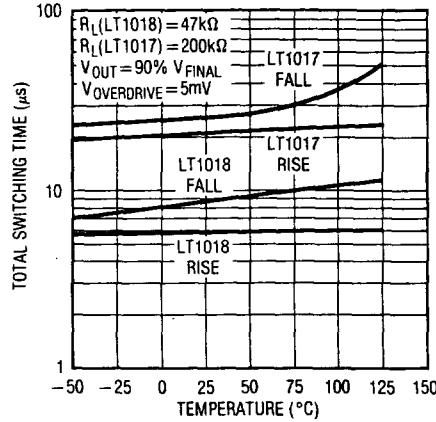

**Output Delay**

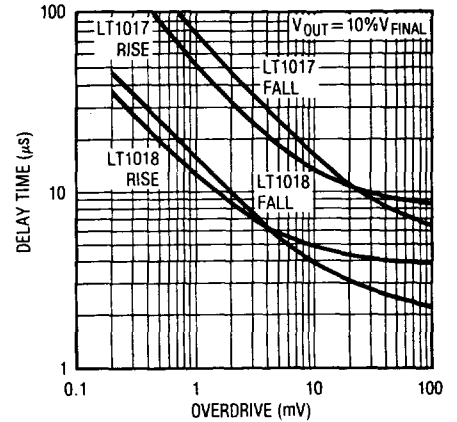

**Transition Time**

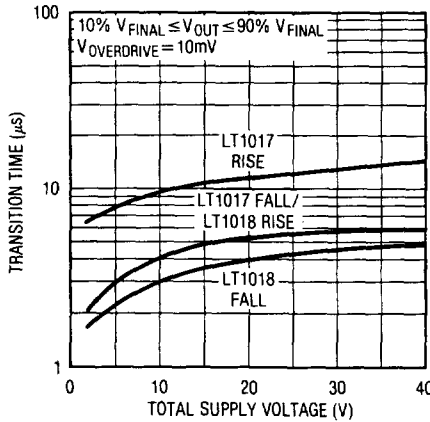

**Positive Transition Time**

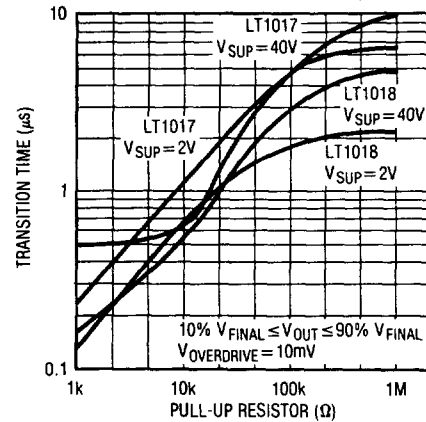

**LT1017 Response Time**

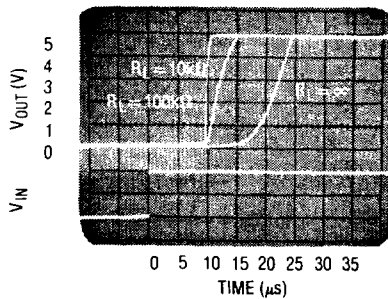

$V^+ = 5V; V^- = 0V$   
 $V_{IN} = 100mV$  WITH  
10mV OVERDRIVE

**LT1017 Response Time**

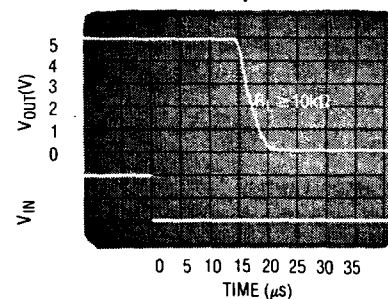

$V^+ = 5V; V^- = 0V$   
 $V_{IN} = 100mV$  WITH  
10mV OVERDRIVE

**LT1018 Response Time**

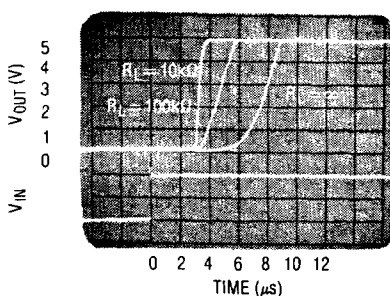

$V^+ = 5V; V^- = 0V$   
 $V_{IN} = 100mV$  WITH  
10mV OVERDRIVE

**LT1018 Response Time**

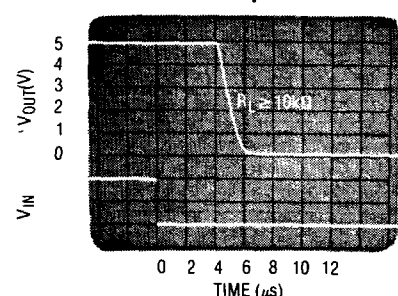

$V^+ = 5V; V^- = 0V$   
 $V_{IN} = 100mV$  WITH  
10mV OVERDRIVE

APPLICATIONS

LT1018 Op Amp,  $A_v = 100$

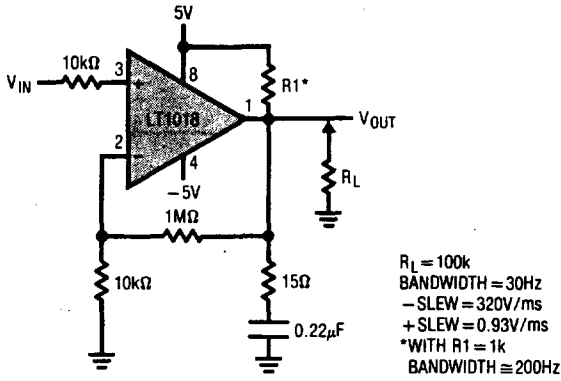

LT1017 Op Amp,  $A_v = 100$

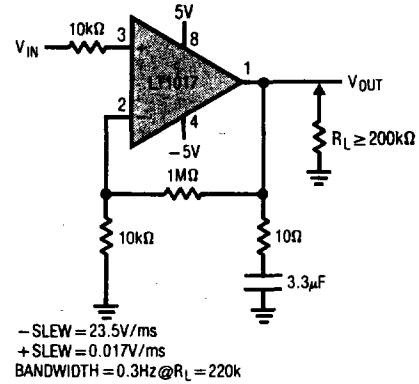

Negative Voltage Regulator

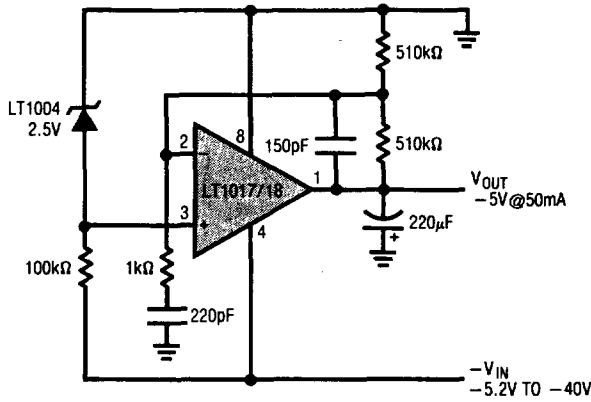

2-Wire Comparator

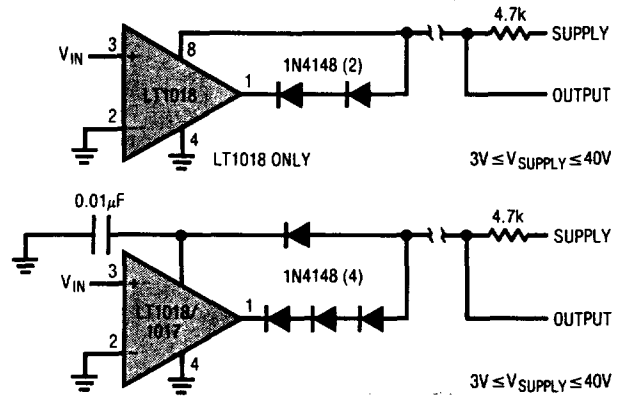

5V Power Supply Monitor

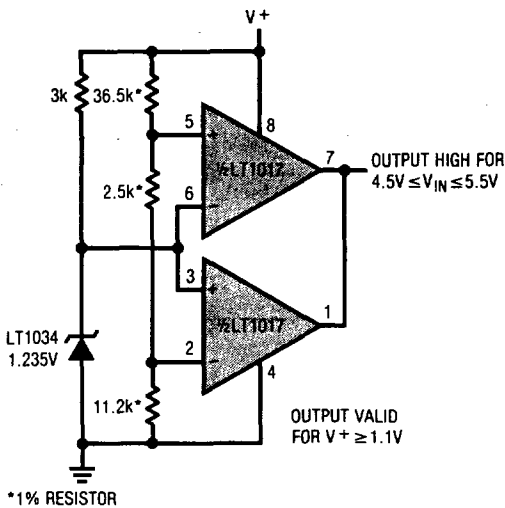

Precise Tri-Wave Generator

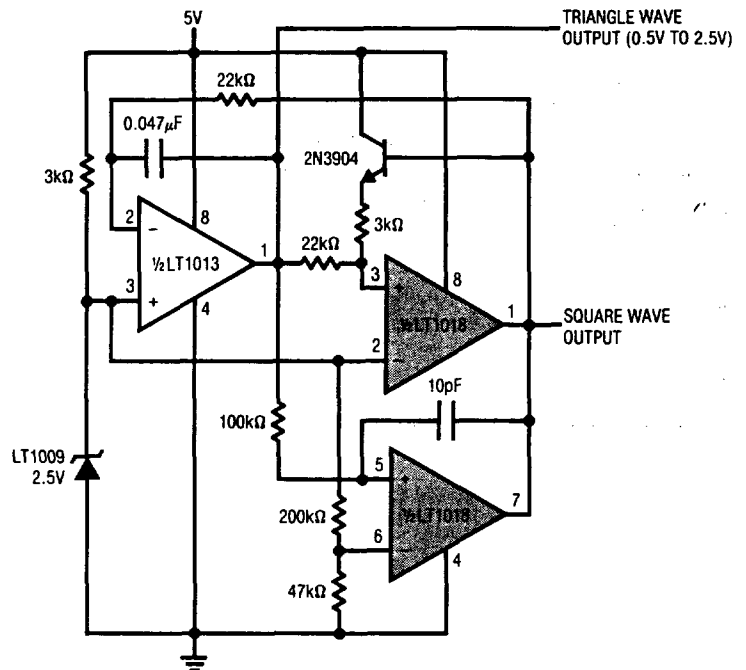

APPLICATIONS

Power Supply Monitor

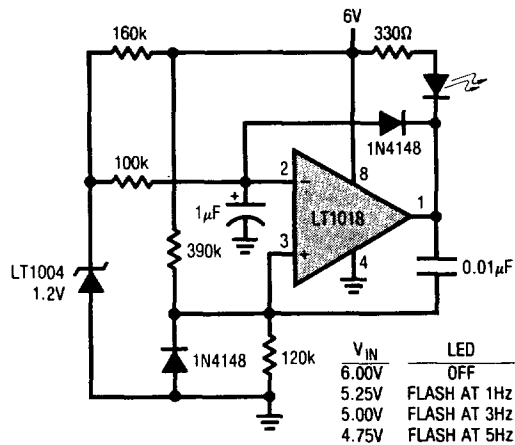

1.5V Input Flyback Regulator

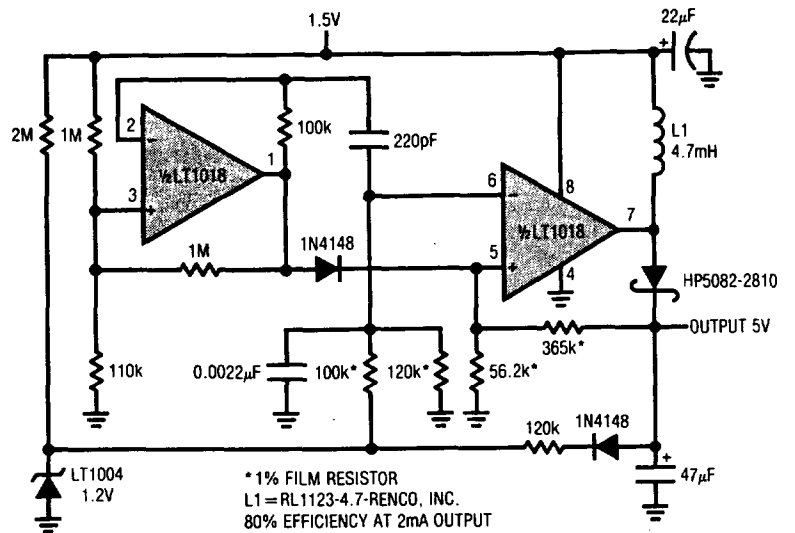

Regulated Up Converter

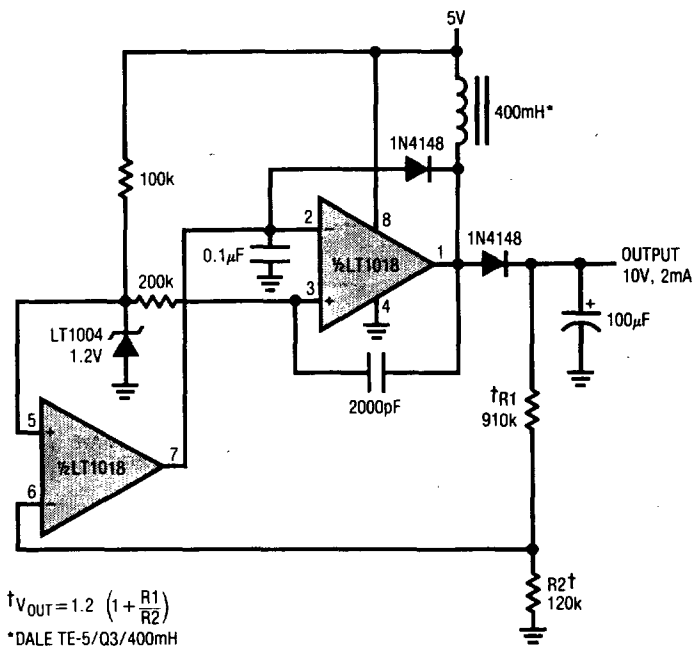

Low Power\* V to F Converter

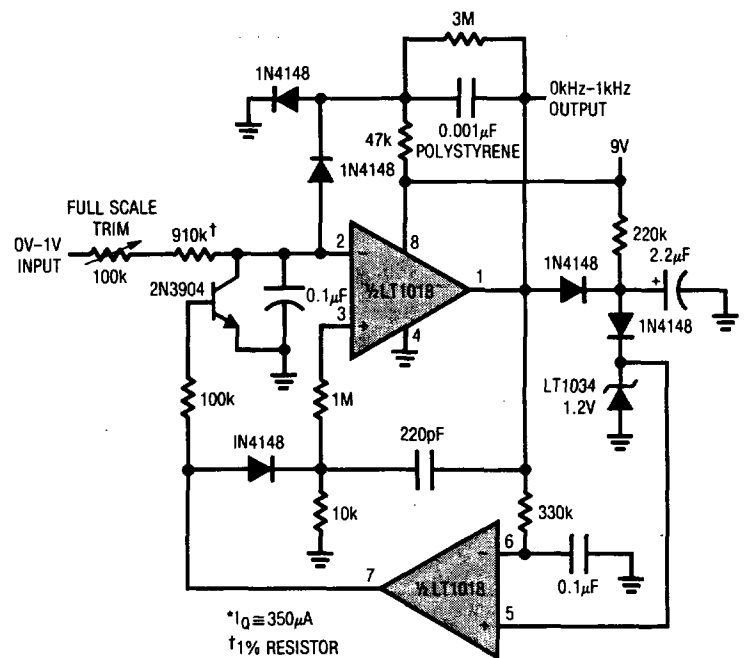

**APPLICATIONS**

**Fully Isolated Limit Comparator**

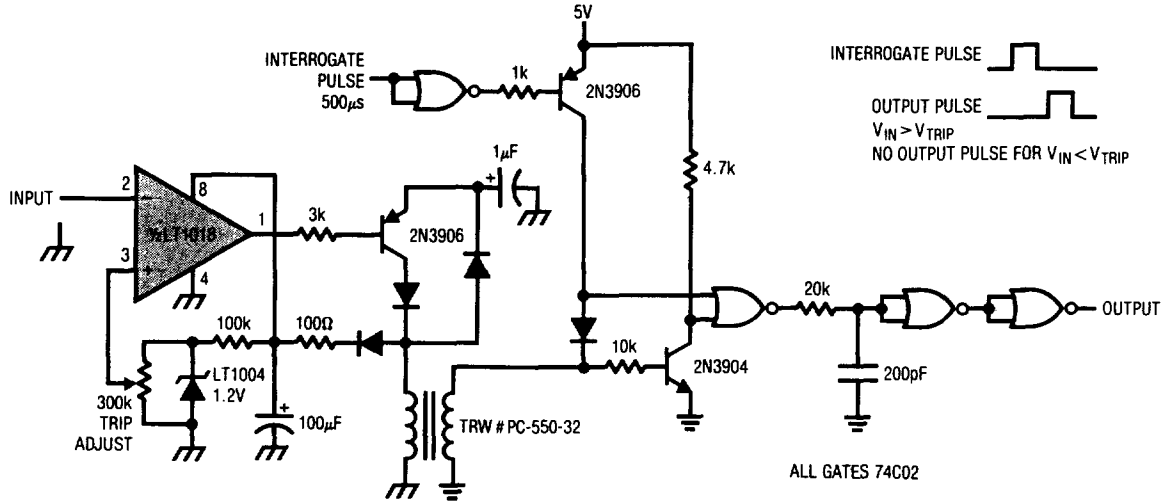

**Driving Relays**

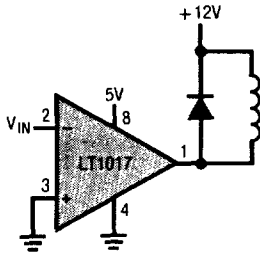

**Increasing Positive Output Current**

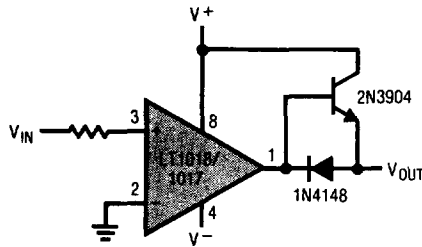

**Delay On Power Up**

