

High Speed, Precision, JFET Input Instrumentation Amplifier (Fixed Gain = 10 or 100)

FEATURES

■ Slew Rate	30V/ μ s
■ Gain-Bandwidth Product	35MHz
■ Settling Time (0.01%)	3 μ s
■ Overdrive Recovery	0.4 μ s
■ Gain Error	0.05% Max
■ Gain Drift	5ppm/ $^{\circ}$ C
■ Gain Non-Linearity	16ppm Max
■ Offset Voltage (Input + Output)	600 μ V Max
– Drift with Temperature	2.5 μ V/ $^{\circ}$ C
■ Input Bias Current	40pA Max
■ Input Offset Current	40pA Max
– Drift with Temperature (to 70 $^{\circ}$ C)	0.5pA/ $^{\circ}$ C

APPLICATIONS

- Fast Settling Analog Signal Processing
- Multiplexed Input Data Acquisition Systems
- High Source Impedance Signal Amplification from High Resistance Bridges, Capacitance Sensors, Photodetector Sensors
- Bridge Amplifier with <1Hz Lowpass Filtering

DESCRIPTION

The LT1102 is the first fast FET input instrumentation amplifier offered in the low cost, space saving 8-pin packages. Fixed gains of 10 and 100 are provided with excellent gain accuracy (0.01%) and non-linearity (3ppm). No external gain setting resistor is required.

Slew rate, settling time, gain-bandwidth product, overdrive recovery time are all improved compared to competitive high speed instrumentation amplifiers.

Industry best speed performance is combined with impressive precision specifications: less than 10pA input bias and offset currents, 200 μ V offset voltage. Unlike other FET input instrumentation amplifiers, on the LT1102 there is no output offset voltage contribution to total error, and input bias currents do not double with every 10 $^{\circ}$ C rise in temperature. Indeed, at 70 $^{\circ}$ C ambient temperature the input bias current is only 50pA.

3

Wideband Instrumentation Amplifier with ± 150 mA Output Current

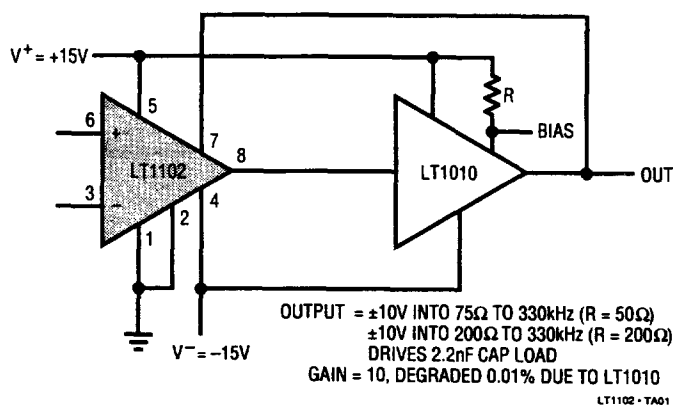

Slew Rate

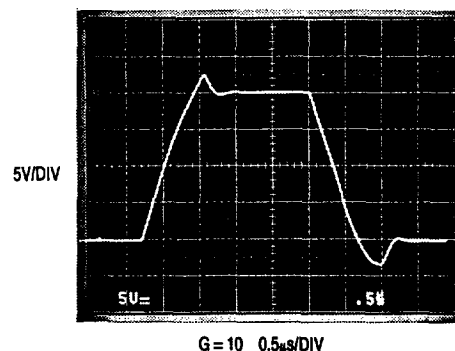

ABSOLUTE MAXIMUM RATINGS

Supply Voltage	$\pm 20V$
Differential Input Voltage	$\pm 40V$
Input Voltage	$\pm 20V$
Output Short Circuit Duration	Indefinite
Operating Temperature Range	
LT1102AM/LT1102M	$-55^{\circ}C$ to $125^{\circ}C$
LT1102I	$-40^{\circ}C$ to $85^{\circ}C$
LT1102AC/LT1102C	$0^{\circ}C$ to $70^{\circ}C$
Storage Temperature Range	
All Grades	$-65^{\circ}C$ to $150^{\circ}C$
Lead Temperature (Soldering, 10 sec.)	$300^{\circ}C$

PACKAGE/ORDER INFORMATION

<p>TOP VIEW OUTPUT</p> <p>H PACKAGE 8-LEAD TO-5 METAL CAN</p>	<p>ORDER PART NUMBER</p> <p>LT1102AMH LT1102MH LT1102ACH LT1102CH</p>
<p>TOP VIEW</p> <p>J PACKAGE 8-LEAD CERAMIC DIP</p> <p>N PACKAGE 8-LEAD PLASTIC DIP</p>	<p>LT1102IN8 LT1102ACN8 LT1102CN8 LT1102MJ8 LT1102CJ8</p>

Basic Connections

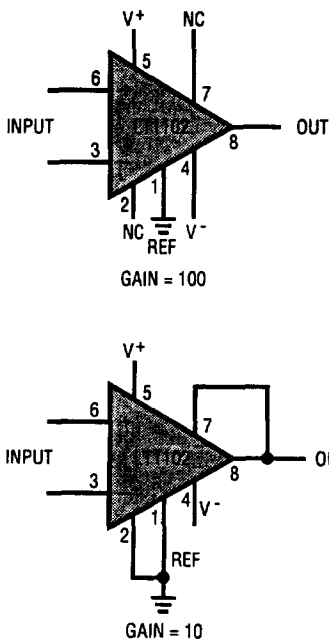

Settling Time Test Circuit

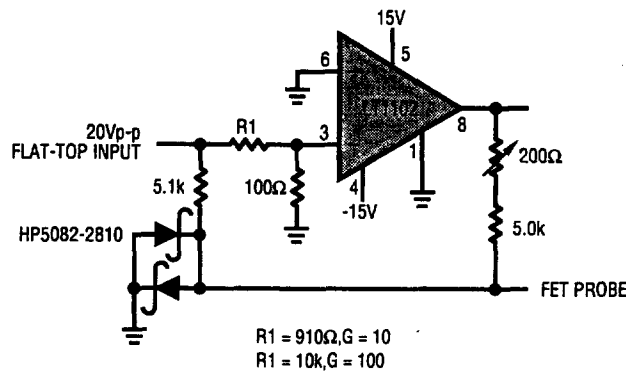

Offset Nulling

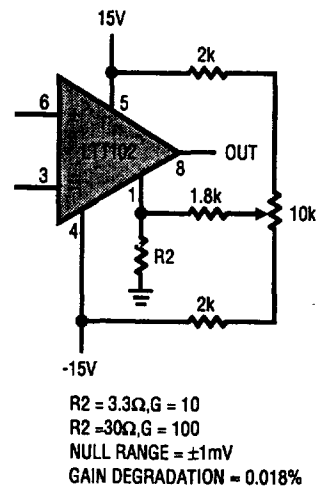

ELECTRICAL CHARACTERISTICS

V_S = ±15V, V_{CM} = 0V, T_A = 25°C, Gain = 10 or 100, unless otherwise noted.

SYMBOL	PARAMETER	CONDITIONS	LT1102AM/AC			LT1102M/IC			UNITS
			MIN	TYP	MAX	MIN	TYP	MAX	
G _E	Gain Error	V _O = ±10V, R _L = 50k or 2k		0.010	0.050		0.012	0.070	%
G _{NL}	Gain Non-Linearity	G = 100, R _L = 50k		3	14		4	18	ppm
		G = 100, R _L = 2k		8	20		8	25	ppm
		G = 10, R _L = 50k or 2k		7	16		7	30	ppm
V _{OS}	Input Offset Voltage			180	600		200	900	μV
I _{OS}	Input Offset Current			3	40		4	60	pA
I _B	Input Bias Current			±3	±40		±4	±60	pA
e _n	Input Resistance Common-Mode	V _{CM} = -11V to 8V		10 ¹²			10 ¹²		Ω
	Differential Mode	V _{CM} = 8V to 11V		10 ¹¹			10 ¹¹		Ω
				10 ¹²			10 ¹²		Ω
e _n	Input Noise Voltage	0.1Hz to 10Hz		2.8			2.8		μVp-p
	Input Noise Voltage Density	f _o = 10Hz f _o = 1000Hz (Note 1)		37 19	30		37 20		nV/√Hz nV/√Hz
	Input Noise Current Density	f _o = 1000Hz, 10Hz (Note 2)		1.5	4		2	5	fA/√Hz
	Input Voltage Range		±10.5	±11.5		±10.5	±11.5		V
CMRR	Common-Mode Rejection Ratio	1k Source Imbalance, V _{CM} = ±10.5V	84	98		82	97		dB
PSRR	Power Supply Rejection Ratio	V _S = ±9V to ±18V	88	102		86	101		dB
I _S	Supply Current			3.3	5.0		3.4	5.6	mA
V _O	Maximum Output Voltage Swing	R _L = 50k	±13.0	±13.5		±13.0	±13.5		V
		R _L = 2k	±12.0	±13.0		±12.0	±13.0		V
BW	Bandwidth	G = 100 (Note 3)	120	220		100	220		kHz
		G = 10 (Note 3)	2.0	3.5		1.7	3.5		MHz
SR	Slew Rate	G = 100, V _{IN} = ±0.13V, V _O = ±5V	12	17		10	17		V/μs
		G = 10, V _{IN} = ±1V, V _O = ±5V	21	30		18	30		V/μs
	Overdrive Recovery	50% Overdrive (Note 4)		400		400			ns
	Settling Time	V _O = 20V Step (Note 3)							
		G = 10 to 0.05%		1.8	4.0		1.8	4.0	μs
		G = 10 to 0.01%		3.0	6.5		3.0	6.5	μs
		G = 100 to 0.05%		7	13		7	13	μs
		G = 100 to 0.01%		9	18		9	18	μs

Note 1: This parameter is tested on a sample basis only.

Note 2: Current noise is calculated from the formula:

$$i_n = (2qI_b)^{1/2}$$

where q = 1.6 × 10⁻¹⁹ coulomb. The noise of source resistors up to 1GΩ swamps the contribution of current noise.

Note 3: This parameter is not tested. It is guaranteed by design and by inference from the slew rate measurement.

Note 4: Overdrive recovery is defined as the time delay from the removal of an input overdrive to the output's return from saturation to linear operation. 50% overdrive equals V_{IN} = ±2V (G = 10) or V_{IN} = ±200mV (G = 100).

Note 5: This parameter is not tested. It is guaranteed by design and by inference from other tests.

3

ELECTRICAL CHARACTERISTICS

$V_S = \pm 15V$, $V_{CM} = 0V$, Gain = 10 or 100, $-55^\circ C \leq T_A \leq 125^\circ C$ for AM/M grades, $-40^\circ C \leq T_A \leq 85^\circ C$ for I grades, unless otherwise noted.

SYMBOL	PARAMETER	CONDITIONS	LT1102AM			LT1102M/I			UNITS
			MIN	TYP	MAX	MIN	TYP	MAX	
G_E	Gain Error	$G = 100, V_O = \pm 10V, R_L = 50k \text{ or } 2k$		0.10	0.25		0.10	0.30	%
		$G = 10, V_O = \pm 10V, R_L = 50k \text{ or } 2k$		0.05	0.12		0.06	0.15	%
TCG_E	Gain Error Drift (Note 5)	$G = 100, R_L = 50k \text{ or } 2k$		9	20		10	25	ppm/ $^\circ C$
		$G = 10, R_L = 50k \text{ or } 2k$		5	10		6	14	ppm/ $^\circ C$
G_{NL}	Gain Non-Linearity	$G = 100, R_L = 50k$		20	70		24	90	ppm
		$G = 100, R_L = 2k$		28	85		32	110	ppm
		$G = 10, R_L = 50k \text{ or } 2k$		9	20		9	24	ppm
V_{OS}	Input Offset Voltage			300	1400		400	2000	μV
$\Delta V_{OS}/\Delta T$	Input Offset Voltage Drift	(Note 5)		2	8		3	12	$\mu V/^\circ C$
I_{OS}	Input Offset Current			0.3	4		0.4	6	nA
I_B	Input Bias Current			± 2	± 10		± 2.5	± 15	nA
CMRR	Common-Mode Rejection Ratio	$V_{CM} = \pm 10.3V$		82	97		80	96	dB
PSRR	Power Supply Rejection Ratio	$V_S = \pm 10V \text{ to } \pm 17V$		86	100		84	99	dB
I_S	Supply Current	$T_A = 125^\circ C$		2.5			2.5		mA
V_O	Maximum Output Voltage Swing	$R_L = 50k$	± 12.5	± 13.2		± 12.5	± 13.2		V
		$R_L = 2k$	± 12.0	± 12.6		± 12.0	± 12.6		V

ELECTRICAL CHARACTERISTICS

$V_S = \pm 15V$, $V_{CM} = 0V$, Gain = 10 or 100, $0^\circ C \leq T_A \leq 70^\circ C$, unless otherwise noted.

SYMBOL	PARAMETER	CONDITIONS	LT1102AC			LT1102C			UNITS
			MIN	TYP	MAX	MIN	TYP	MAX	
G_E	Gain Error	$G = 100, V_O = \pm 10V, R_L = 50k \text{ or } 2k$		0.04	0.11		0.05	0.14	%
		$G = 10, V_O = \pm 10V, R_L = 50k \text{ or } 2k$		0.03	0.09		0.04	0.12	%
TCG_E	Gain Error Drift (Note 5)	$G = 100, R_L = 50k \text{ or } 2k$		8	18		9	22	ppm/ $^\circ C$
		$G = 10, R_L = 50k \text{ or } 2k$		5	10		6	14	ppm/ $^\circ C$
G_{NL}	Gain Non-Linearity	$G = 100, R_L = 50k$		8	30		9	40	ppm
		$G = 100, R_L = 2k$		11	36		12	48	ppm
		$G = 10, R_L = 50k \text{ or } 2k$		8	18		8	22	ppm
V_{OS}	Input Offset Voltage			230	1000		280	1400	μV
$\Delta V_{OS}/\Delta T$	Input Offset Voltage Drift	(Note 5)		2	8		3	12	$\mu V/^\circ C$
I_{OS}	Input Offset Current			10	150		15	220	pA
$\Delta I_{OS}/\Delta T$	Input Offset Current Drift	(Note 5)		0.5	3		0.5	4	pA/ $^\circ C$
I_B	Input Bias Current			± 40	± 300		± 50	± 400	pA
$\Delta I_B/\Delta T$	Input Bias Current Drift	(Note 5)		1	4		1	6	pA/ $^\circ C$
CMRR	Common-Mode Rejection Ratio	$V_{CM} = \pm 10.3V$		83	98		81	97	dB
PSRR	Power Supply Rejection Ratio	$V_S = \pm 10V \text{ to } \pm 17V$		87	101		85	100	dB
I_S	Supply Current	$T_A = 70^\circ C$		2.8			2.9		mA
V_O	Maximum Output Voltage Swing	$R_L = 50k$	± 12.8	± 13.4		± 12.8	± 13.4		V
		$R_L = 2k$	± 12.0	± 12.8		± 12.0	± 12.8		V

TYPICAL PERFORMANCE CHARACTERISTICS

Small Signal Response, G = 10
(Input = 50mV Pulse)

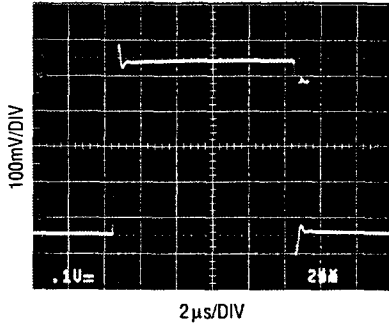

Small Signal Response, G = 100
(Input = 5mV Pulse)

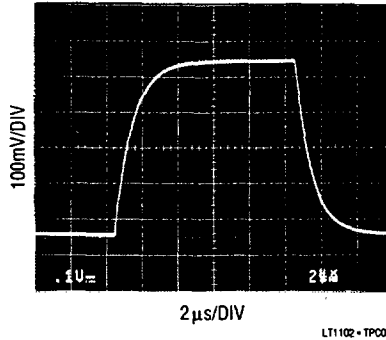

Slew Rate, G = 100
(Input = ±130mV Pulse)

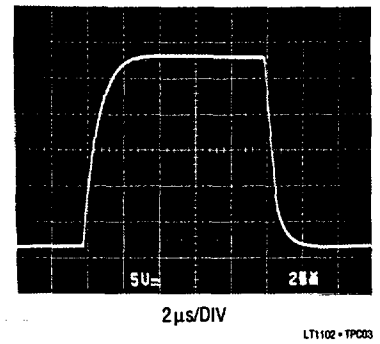

Settling Time, G = 10
(Input From -10V to +10V)

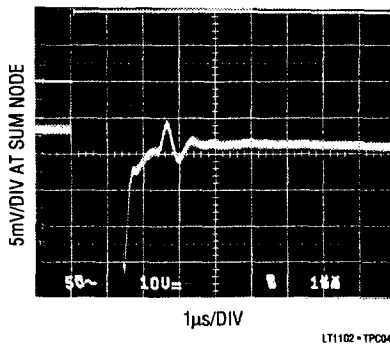

Settling Time, G = 10
(Input From +10V to -10V)

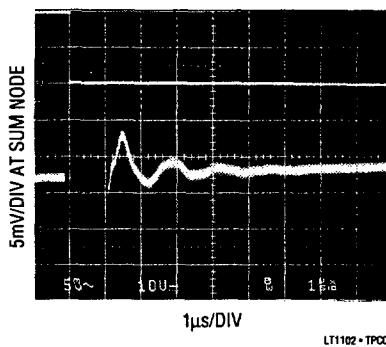

Settling Time, G = 100
(Input From -10V to +10V)

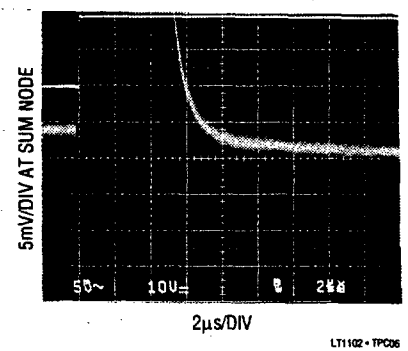

Settling Time, G = 100
(Input From +10V to -10V)

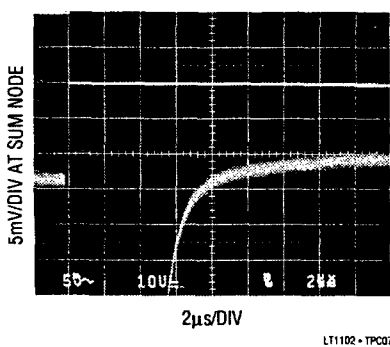

Capacitive Load Handling

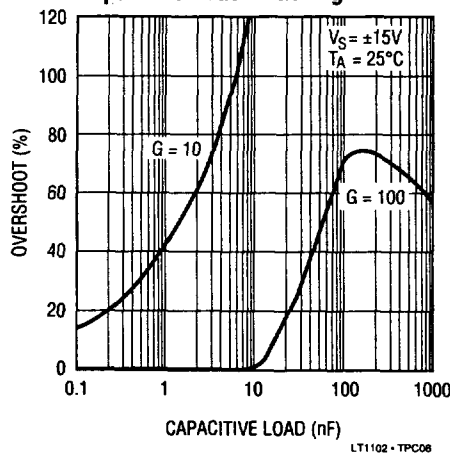

Output Impedance vs Frequency

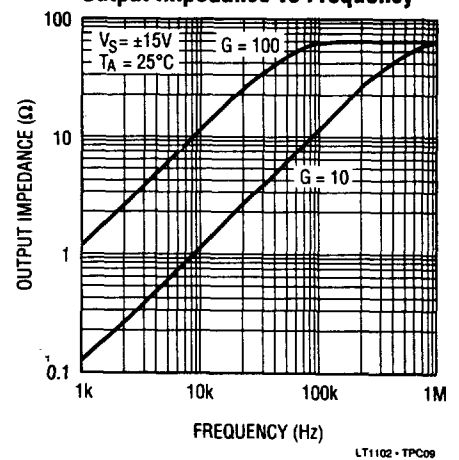

3

TYPICAL PERFORMANCE CHARACTERISTICS

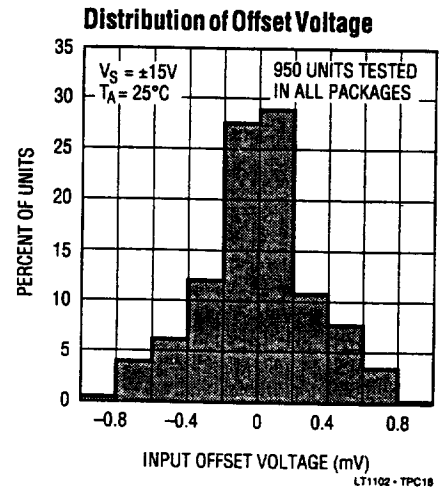
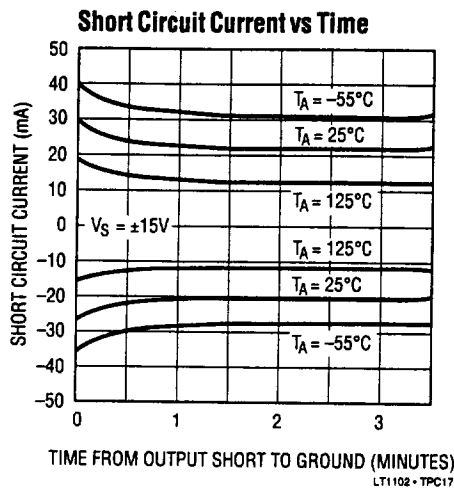
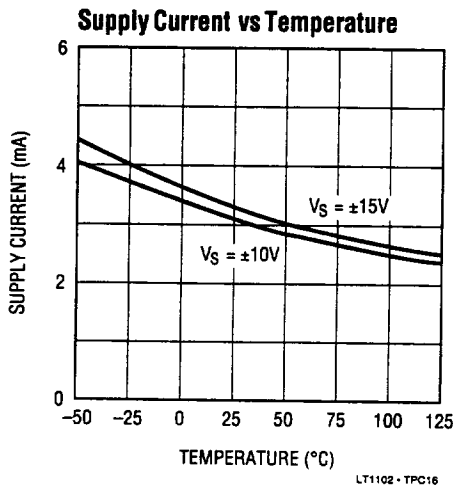
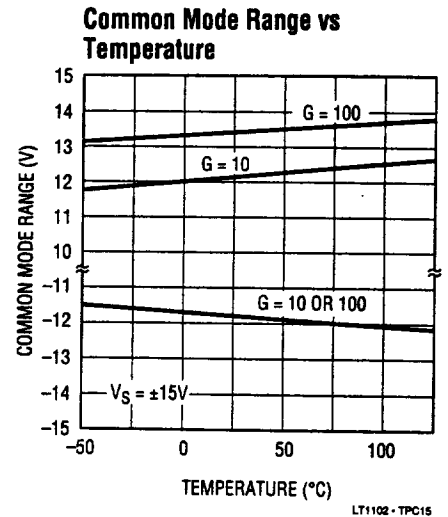
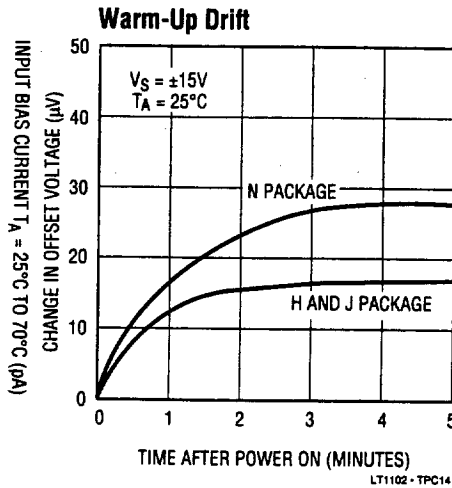
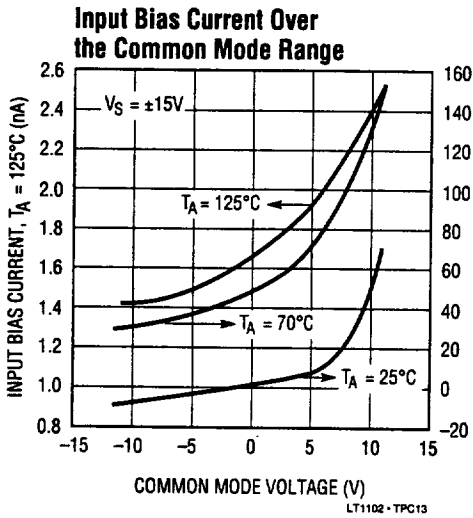
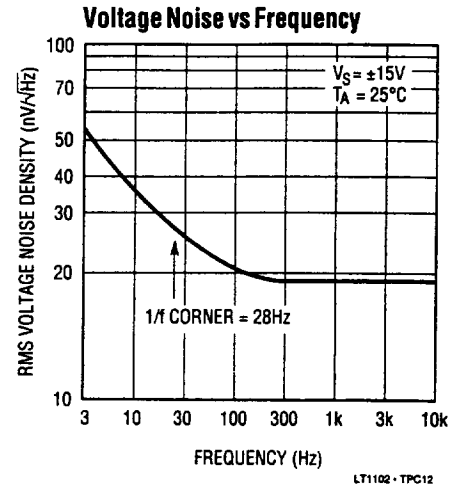
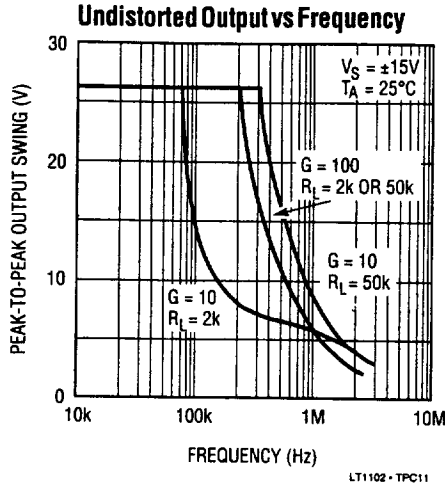
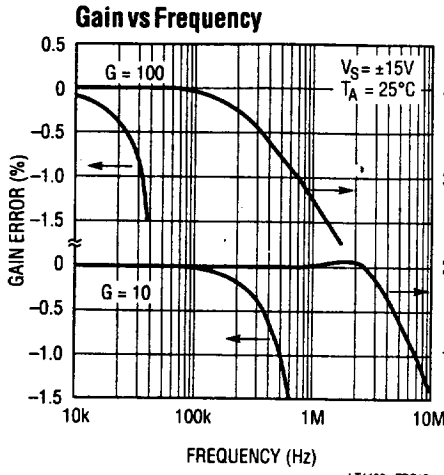

TYPICAL PERFORMANCE CHARACTERISTICS

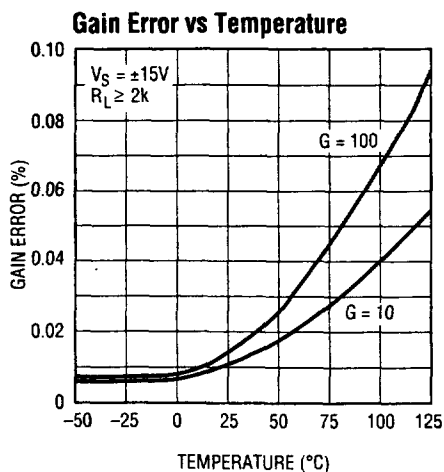

LT1102 - TPC19

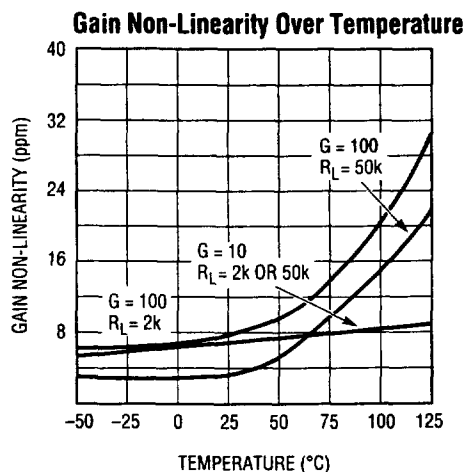

LT1102 - TPC20

APPLICATIONS INFORMATION

In the two op amp instrumentation amplifier configuration, the first amplifier is basically in unity gain, and the second amplifier provides all the voltage gain. In the LT1102 the second amplifier is decompensated for gain of 10 stability, therefore high slew rate and bandwidth are achieved. Common mode rejection versus frequency is also optimized in the $G = 10$ mode, because the bandwidths of the two op amps are similar. When $G = 100$ this statement is no longer true. However, by connecting an 18pF capacitor between pins 1 and 2, a common mode AC gain is created to cancel the inherent roll-off. From 200Hz to 30kHz CMRR versus frequency is improved by an order of magnitude.

Input Protection

Instrumentation amplifiers are often used in harsh environments where overload conditions can occur. The LT1102 employs FET input transistors, consequently the differential input voltage can be $\pm 30V$ (with $\pm 15V$ supplies, $\pm 36V$ with $\pm 18V$ supplies) Some competitive instrumentation amplifiers have NPN inputs which are protected by back to back diodes. When the differential input voltage exceeds $\pm 1.3V$ on these competitive devices, input current increases to milliampere level; more than $\pm 10V$ differential voltage can cause permanent damage.

When the LT1102 inputs are pulled below the negative supply or above the positive supply, the inputs will clamp a diode voltage below or above the supplies. No damage will occur if the input current is limited to 20mA.

Common Mode Rejection Ratio vs Frequency

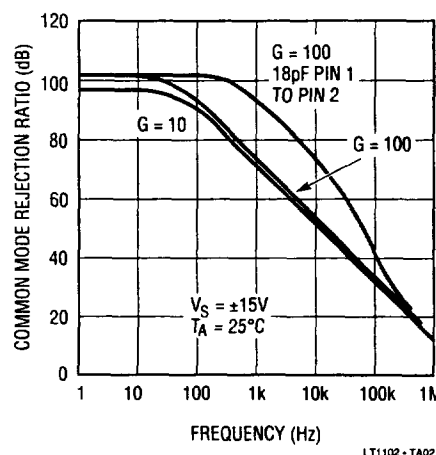

LT1102 - TA02

Gains Between 10 and 100

Gains between 10 and 100 can be achieved by connecting two equal resistors ($=R_x$) between pins 1 and 2 and pins 7 and 8.

$$\text{Gain} = 10 + \frac{R_x}{R + R_x/90}$$

The nominal value of R is $1.84k\Omega$. The usefulness of this method is limited by the fact that R is not controlled to better than $\pm 10\%$ absolute accuracy in production. However, on any specific unit 90R can be measured between pins 1 and 2.

APPLICATIONS INFORMATION

Gain = 20, 110, or 200 Instrumentation Amplifiers

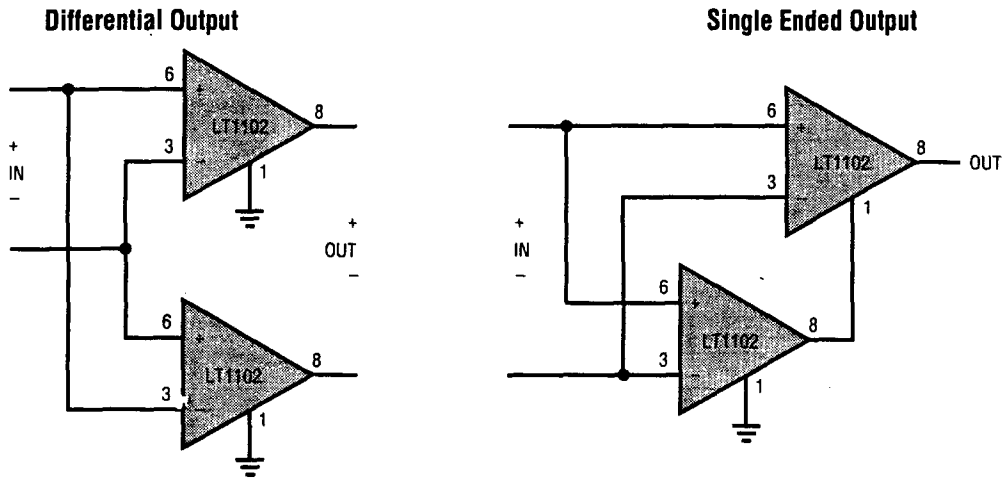

GAIN = 200, AS SHOWN
 GAIN = 20, SHORT PIN 1 TO PIN 2, PIN 7 TO PIN 8 ON BOTH DEVICES
 GAIN = 110, SHORT PIN 1 TO PIN 2, PIN 7 TO PIN 8 ON ONE DEVICE, NOT ON THE OTHER
 INPUT REFERRED NOISE IS REDUCED BY $\sqrt{2}$ (G = 200 OR 20)

LT1102 - TA03

Multiplexed Input Data Acquisition

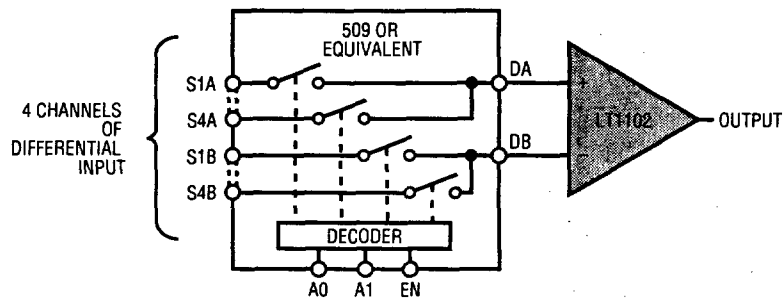

800kHz SIGNALS CAN BE MULTIPLEXED WITH LT1102 IN G = 10

LT1102 - TA04

Voltage Programmable Current Source is Simple and Precise

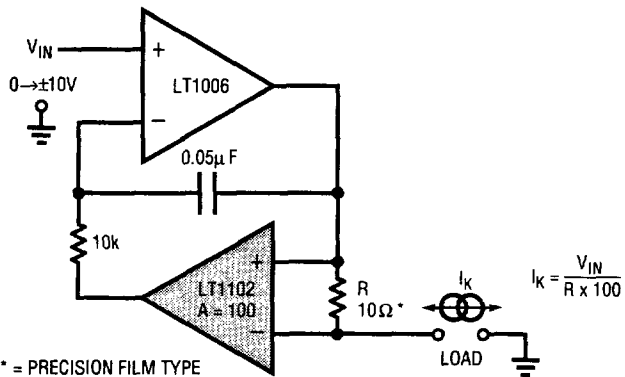

* = PRECISION FILM TYPE

LT1102 - TA05

Dynamic Response of the Current Source

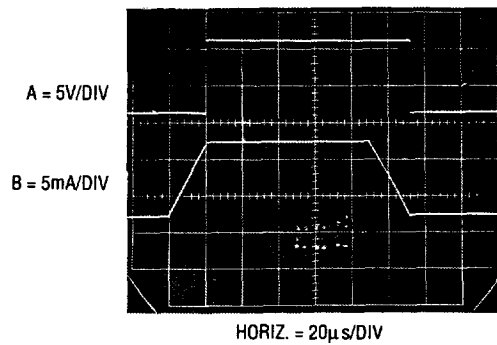

LT1102 - TA06