

## FEATURES

- Gain Bandwidth Product,  $A_V = +1$       50MHz
- Slew Rate      450V/ $\mu$ s
- Low Cost
- Output Current       $\pm 50$ mA
- Settling Time      140ns to 0.1%
- Differential Gain Error      0.1%, ( $R_L = 1k$ )
- Differential Phase Error      0.06°, ( $R_L = 1k$ )
- High Open Loop Gain      15V/mV Min
- Single Supply +5V Operation
- Output Shutdown

## APPLICATIONS

- Video Cable Drivers
- Video Signal Processing
- Fast Integrators
- Pulse Amplifiers
- D/A Current to Voltage Conversion

## DESCRIPTION

The LT1190 is a video operational amplifier optimized for operation on  $\pm 5V$ , and a single +5V supply. Unlike many high speed amplifiers, this amplifier features high open loop gain, over 85dB, and the ability to drive heavy loads to a full power bandwidth of 20MHz at 7Vp-p. In addition to its very fast slew rate, the LT1190 features a unity gain stable bandwidth of 50MHz, and a 75° phase margin, making it extremely easy to use.

Because the LT1190 is a true operational amplifier, it is an ideal choice for wideband signal conditioning, fast integrators, active filters, and applications requiring speed, accuracy, and low cost.

The LT1190 is available in 8-pin miniDIPs and SO packages with standard pinouts. The normally unused pin 5 is used for a shutdown feature that shuts off the output and reduces power dissipation to a mere 15mW.

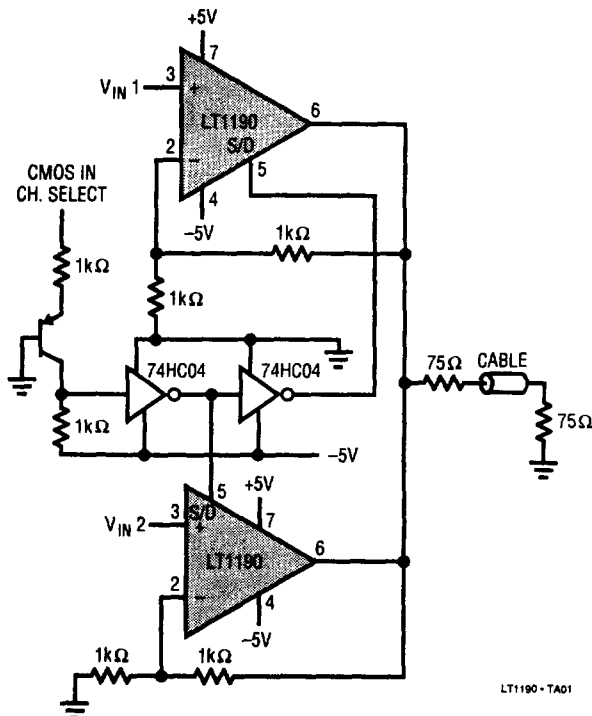
**Video MUX Cable Driver**

LT1190 - TA01

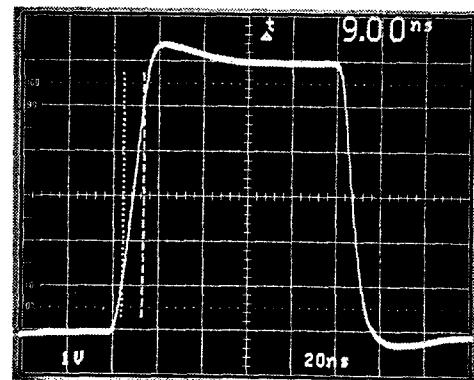
**Inverter Pulse Response**

 $A_V = -1$ ,  $C_L = 10$ pF SCOPE PROBE

LT1190 - TA02

## ABSOLUTE MAXIMUM RATINGS

Total Supply Voltage ( $V^+$ to $V^-$ ) .....	18V
Differential Input Voltage .....	$\pm 6V$
Input Voltage .....	$\pm V_S$
Output Short Circuit Duration (Note 1) .....	Continuous
Operating Junction Temperature Range	
LT1190M .....	$-55^\circ\text{C}$ to $150^\circ\text{C}$
LT1190C .....	$0^\circ\text{C}$ to $150^\circ\text{C}$
Max. Junction Temperature .....	See Pkg. Descriptions
Storage Temperature Range .....	$-65^\circ\text{C}$ to $150^\circ\text{C}$
Lead Temperature (Soldering, 10 sec.) .....	$300^\circ\text{C}$

## PACKAGE/ORDER INFORMATION

	ORDER PART NUMBER
	LT1190MJ8 LT1190CJ8 LT1190CN8 LT1190CS8
	S8 PART MARKING
	1190

2

## ELECTRICAL CHARACTERISTICS $V_S = \pm 5V$ , $T_A = 25^\circ\text{C}$ , $C_L \leq 10\text{pF}$ , pin 5 open circuit unless otherwise noted.

SYMBOL	PARAMETER	CONDITIONS	LT1190M/C			UNITS
			MIN	TYP	MAX	
$V_{OS}$	Input Offset Voltage			3.0	10.0	mV
$I_{OS}$	Input Offset Current			0.2	1.7	$\mu\text{A}$
$I_B$	Input Bias Current			$\pm 0.5$	$\pm 2.5$	$\mu\text{A}$
$e_n$	Input Noise Voltage	$f_0 = 10\text{kHz}$		50		$\text{nV}/\sqrt{\text{Hz}}$
$i_n$	Input Noise Current	$f_0 = 10\text{kHz}$		4.0		$\text{pA}/\sqrt{\text{Hz}}$
$R_{IN}$	Input Resistance	Differential Mode		130		$\text{k}\Omega$
		Common Mode		5.0		$\text{M}\Omega$
$C_{IN}$	Input Capacitance	$A_V = +1$		2.2		pF
	Input Voltage Range	(Note 2)	-2.5		+3.5	V
CMRR	Common Mode Rejection Ratio	$V_{CM} = -2.5V$ to $+3.5V$	60	70		dB
PSRR	Power Supply Rejection Ratio	$V_S = \pm 2.375V$ to $\pm 8.0V$	60	70		dB
$A_{VOL}$	Large Signal Voltage Gain	$R_L = 1\text{k}, V_0 = \pm 3.0V$	10	22		V/mV
		$R_L = 100\Omega, V_0 = \pm 3.0V$	2.5	6		
		$V_S = \pm 8V, R_L = 100\Omega, V_0 = \pm 5V$	3.5	12		
$V_{OUT}$	Output Voltage Swing	$V_S = \pm 5V, R_L = 1\text{k}$	$\pm 3.7$	$\pm 4.0$		V
		$V_S = \pm 8V, R_L = 1\text{k}$	$\pm 6.7$	$\pm 7.0$		
SR	Slew Rate	$A_V = -1, R_L = 1\text{k}$ , (Note 3, 8)	325	450		V/ $\mu\text{s}$
FPBW	Full Power Bandwidth	$V_0 = 6V_{p-p}$ , (Note 4)	17.2	23.9		MHz
GBW	Gain Bandwidth Product			50		MHz
$t_{r1}, t_{f1}$	Rise Time, Fall Time	$A_V = +50, V_0 = \pm 1.5V$ , 20% to 80%, (Note 8)	175	250	325	ns
$t_{r2}, t_{f2}$	Rise Time, Fall Time	$A_V = +1, V_0 = \pm 125\text{mV}$ , 10% to 90%		1.9		ns
$t_{PD}$	Propagation Delay	$A_V = +1, V_0 = \pm 125\text{mV}$ , 50% to 50%		2.4		ns
	Overshoot	$A_V = +1, V_0 = \pm 125\text{mV}$		5		%
$t_s$	Settling Time	3V Step, 0.1%, (Note 5)		140		ns
Diff $A_V$	Differential Gain	$R_L = 150\Omega, A_V = +2$ , (Note 6)		0.35		%
Diff Ph	Differential Phase	$R_L = 150\Omega, A_V = +2$ , (Note 6)		0.16		Deg. p-p

LT1190

**ELECTRICAL CHARACTERISTICS**  $V_S = \pm 5V$ ,  $T_A = 25^\circ C$ ,  $C_L \leq 10pF$ , pin 5 open circuit unless otherwise noted.

SYMBOL	PARAMETER	CONDITIONS	LT1190M/C			UNITS
			MIN	TYP	MAX	
$I_S$	Supply Current			32	38	mA
	Shutdown Supply Current	Pin 5 at $V^-$		1.3	2.0	mA
$I_{S/D}$	Shutdown Pin Current	Pin 5 at $V^-$		20	50	$\mu A$
$t_{on}$	Turn On Time	Pin 5 from $V^-$ to Ground, $R_L = 1k$		100		ns
$t_{off}$	Turn Off Time	Pin 5 from Ground to $V^-$ , $R_L = 1k$		400		ns

**ELECTRICAL CHARACTERISTICS**

$V_{S+} = +5V$ ,  $V_{S-} = 0V$ ,  $V_{CM} = +2.5V$ ,  $T_A = 25^\circ C$ ,  $C_L \leq 10pF$ , pin 5 open circuit unless otherwise noted.

SYMBOL	PARAMETER	CONDITIONS	LT1190M/C			UNITS
			MIN	TYP	MAX	
$V_{OS}$	Input Offset Voltage			3.0	11.0	mV
$I_{OS}$	Input Offset Current			0.2	1.2	$\mu A$
$I_B$	Input Bias Current			$\pm 0.5$	$\pm 1.5$	$\mu A$
	Input Voltage Range	(Note 2)	+2.0		+3.5	V
CMRR	Common Mode Rejection Ratio	$V_{CM} = +2.0V$ to $+3.5V$	55	70		dB
$A_{VOL}$	Large Signal Voltage Gain	$R_L = 100\Omega$ to Ground	85	70		dB

**ELECTRICAL CHARACTERISTICS**  $V_S = \pm 5V, 0^\circ C \leq T_A \leq 70^\circ C$ , pin 5 open circuit unless otherwise noted.

SYMBOL	PARAMETER	CONDITIONS	LT1190C			UNITS
			MIN	TYP	MAX	
$V_{OS}$	Input Offset Voltage		●	3.0	11.0	mV
$\Delta V_{OS}/\Delta T$	Input $V_{OS}$ Drift		●	16		$\mu V/^\circ C$
$I_{OS}$	Input Offset Current		●	0.2	1.7	$\mu A$
$I_B$	Input Bias Current		●	$\pm 0.5$	$\pm 2.5$	$\mu A$
CMRR	Common Mode Rejection Ratio	$V_{CM} = -2.5V$ to $+3.5V$	●	58	70	dB
PSRR	Power Supply Rejection Ratio	$V_S = \pm 2.375V$ to $\pm 5.0V$	●	58	70	dB
$A_{VOL}$	Large Signal Voltage Gain	$R_L = 1k, V_O = \pm 3.0V$	●	9	20	V/mV
		$R_L = 100\Omega, V_O = \pm 3.0V$	●	2.0	6.0	
$V_{OUT}$	Output Voltage Swing	$R_L = 1k$	●	$\pm 3.70$	$\pm 3.9$	V
$I_S$	Supply Current		●	32	38	mA
	Shutdown Supply Current	Pin 5 at $V^-$ , (Note 7)	●	1.4	2.1	mA
$I_{S/D}$	Shutdown Pin Current	Pin 5 at $V^-$	●	20		$\mu A$

The ● denotes the specifications which apply over the full operating temperature range.

**Note 1:** A heat sink is required to keep the junction temperature below absolute maximum when the output is shorted.

**Note 2:** Exceeding the input common mode range may cause the output to invert.

**Note 3:** Slew rate is measured between  $\pm 1V$  on the output, with a  $\pm 3V$  input step.

**Note 4:** Full power bandwidth is calculated from the slew rate measurement:  $FPBW = SR/2\pi V_p$ .

**Note 5:** Settling time measurement techniques are shown in "Take the Guesswork Out of Settling Time Measurements," EDN, September 19, 1985.  $A_V = -1, R_L = 1k$ .

**Note 6:** NTSC (3.58MHz). For  $R_L = 1k, \text{Diff } A_V = 0.1\%, \text{Diff Ph} = 0.06^\circ$ .

**Note 7:** See Applications section for shutdown at elevated temperatures. Do not operate the shutdown above  $T_J > 125^\circ C$ .

**Note 8:** AC parameters are 100% tested on the ceramic and plastic DIP packaged parts (J and N suffix) and are sample tested on every lot of the SO packaged parts (S suffix).

2

**Optional Offset Nulling Circuit**

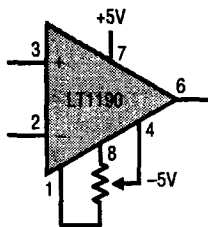

INPUT OFFSET VOLTAGE CAN BE ADJUSTED OVER A  $\pm 150mV$  RANGE WITH A  $1k\Omega$  TO  $10k\Omega$  POTENTIOMETER.

LT1190-TAQ3

# TYPICAL PERFORMANCE CHARACTERISTICS

**Input Bias Current vs Common Mode Voltage**

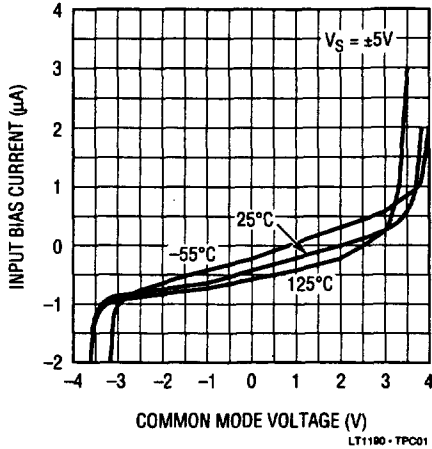

**Input Bias Current vs Temperature**

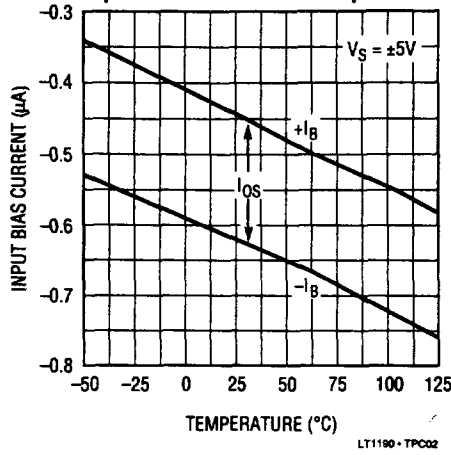

**Common Mode Voltage vs Supply Voltage**

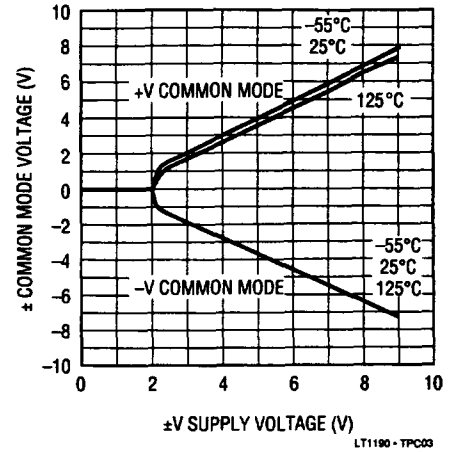

**Equivalent Input Noise Voltage vs Frequency**

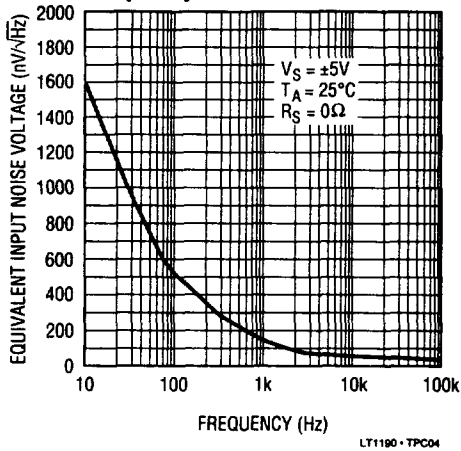

**Equivalent Input Noise Current vs Frequency**

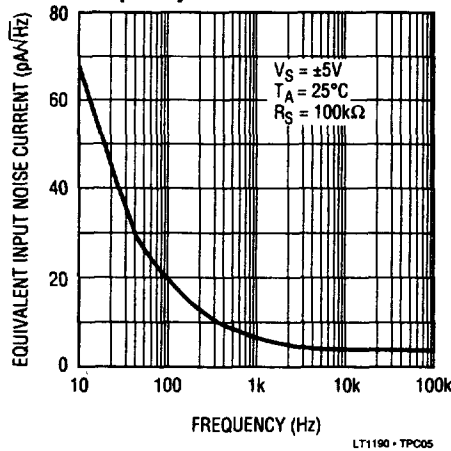

**Supply Current vs Supply Voltage**

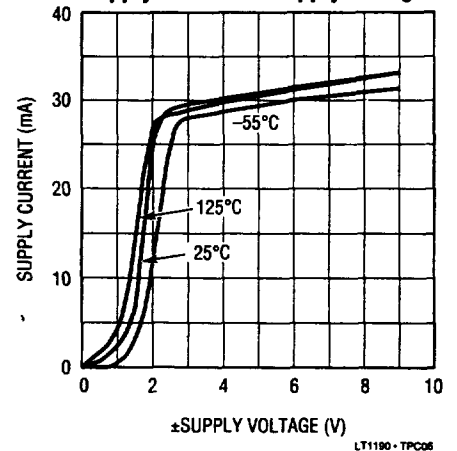

**Shutdown Supply Current vs Temperature**

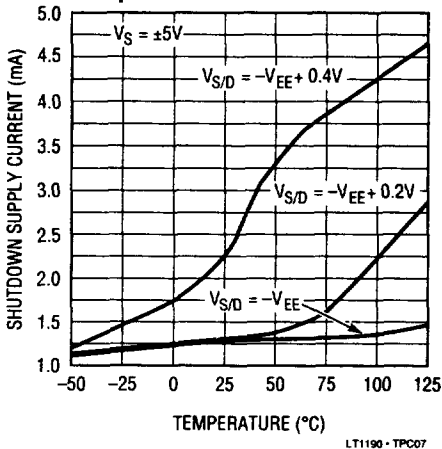

**Open Loop Voltage Gain vs Temperature**

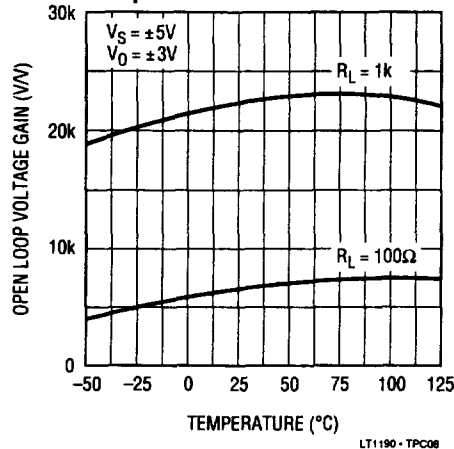

**Open Loop Voltage Gain vs Load Resistance**

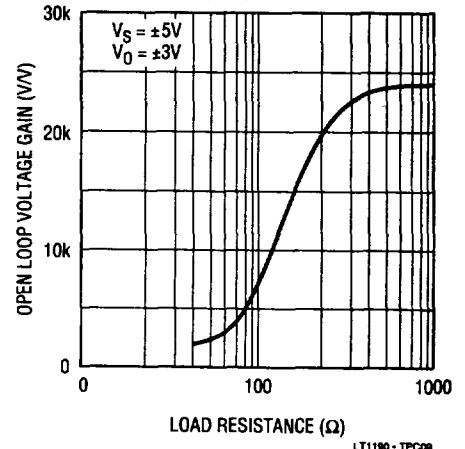

# TYPICAL PERFORMANCE CHARACTERISTICS

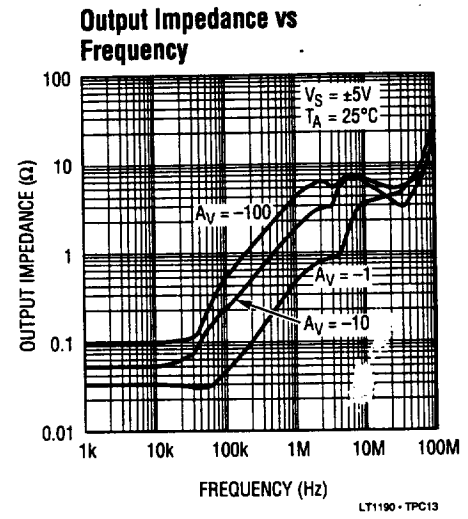
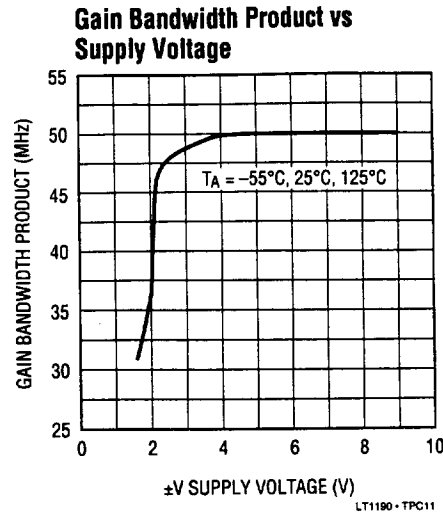
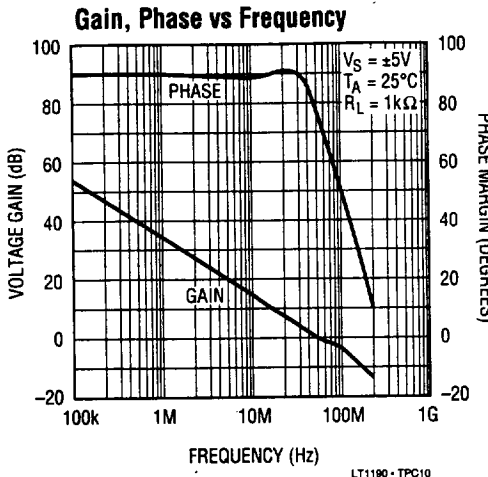

2

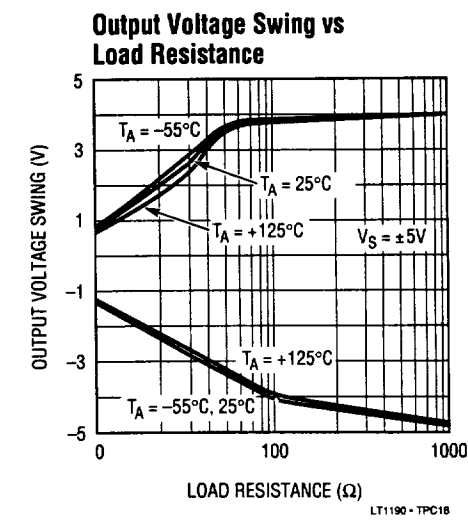
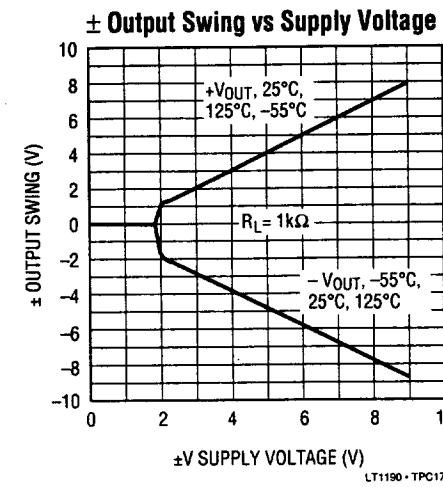
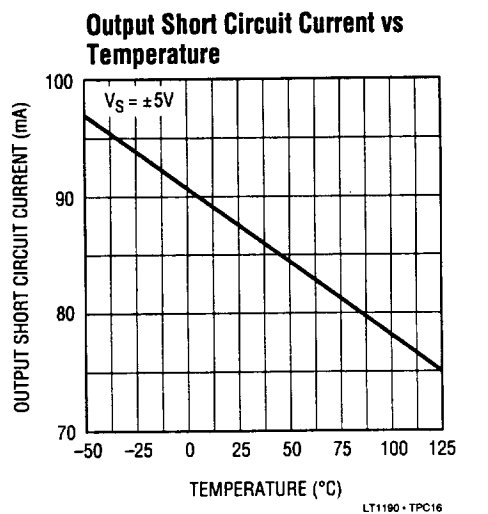
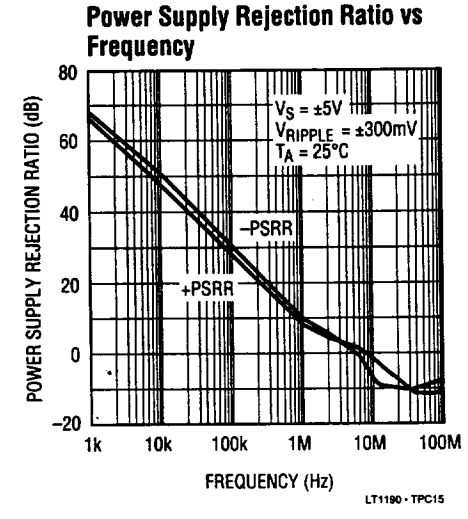
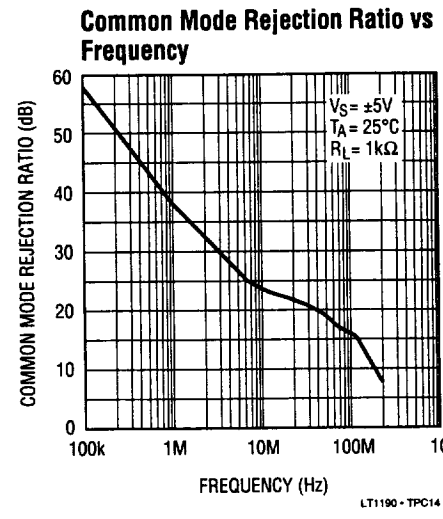
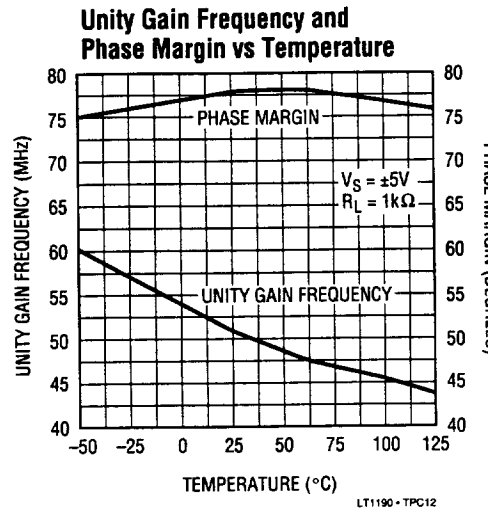

# TYPICAL PERFORMANCE CHARACTERISTICS

**Slew Rate vs Temperature**

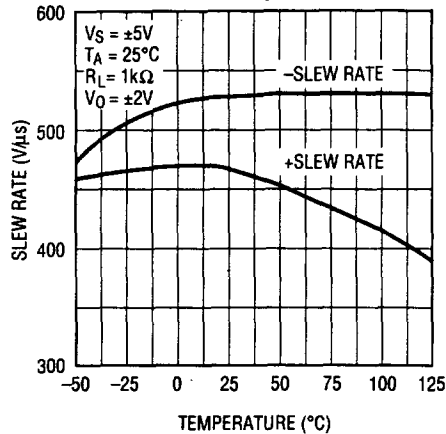

LT1190 - TPC19

**Output Voltage Step vs Settling Time,  $A_V = -1$**

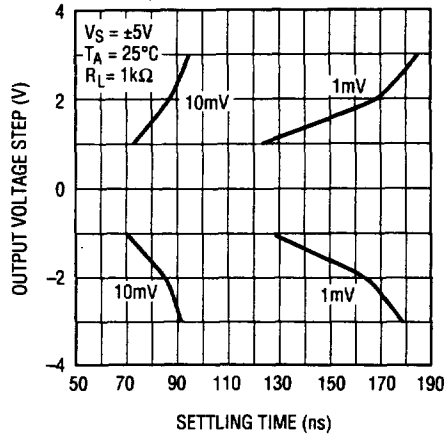

LT1190 - TPC20

**Output Voltage Step vs Settling Time,  $A_V = +1$**

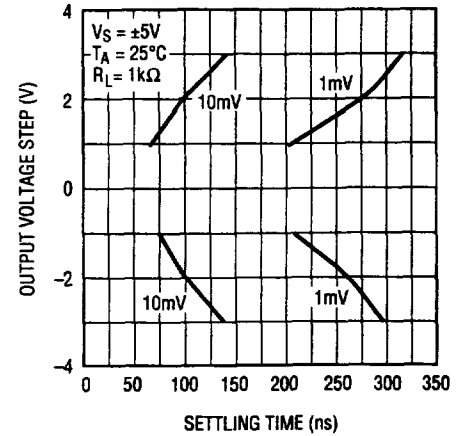

LT1190 - TPC21

**Large Signal Transient Response**

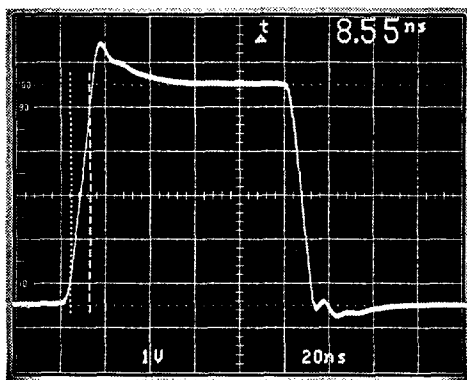

$A_V = +1, C_L = 10pF$  SCOPE PROBE

LT1190 - TPC22

**Output Overload**

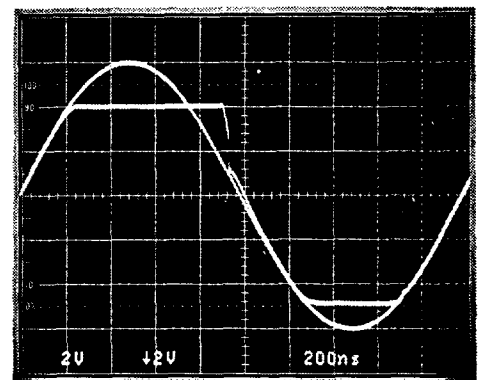

$A_V = -1, V_{IN} = 12Vp-p$

LT1190 - TPC23

**Small Signal Transient Response**

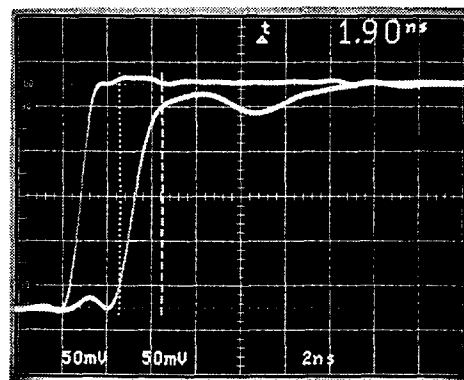

$A_V = +1, \text{SMALL SIGNAL RISE TIME, WITH FET PROBES}$

LT1190 - TPC24

# APPLICATIONS INFORMATION

## Power Supply Bypassing

The LT1190 is quite tolerant of power supply bypassing. In some applications a 0.1 $\mu$ F ceramic disc capacitor placed 1/2 inch from the amplifier is all that is required. A scope photo of the amplifier output with no supply bypassing is used to demonstrate this bypassing tolerance,  $R_L = 1k\Omega$ .

No Supply Bypass Capacitors

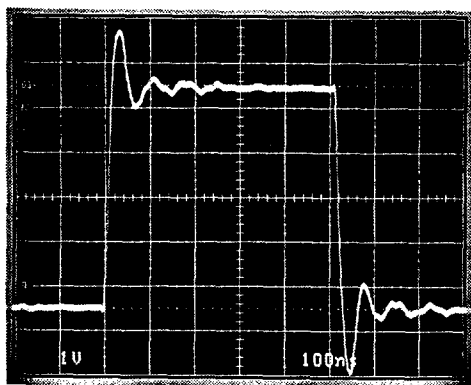

$A_V = -1$ , IN DEMO BOARD,  $R_L = 1k\Omega$

LT1190 - TA04

Supply bypassing can also affect the response in the frequency domain. It is possible to see a slight 1dB rise in the frequency response at 130MHz depending on the gain configuration, supply bypass, inductance in the supply leads, and printed circuit board layout. This can be further minimized by not using a socket.

Closed Loop Voltage Gain vs Frequency

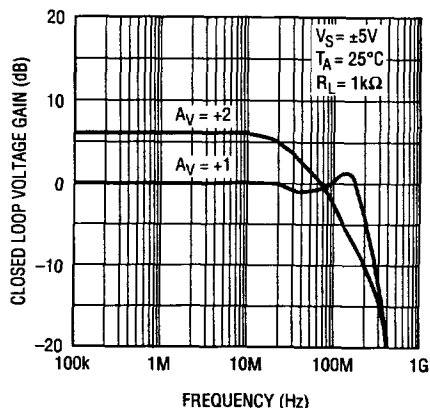

LT1190 - TA05

In most applications, and those requiring good settling time, it is important to use multiple bypass capacitors. A 0.1 $\mu$ F ceramic disc in parallel with a 4.7 $\mu$ F tantalum is recommended. Two oscilloscope photos with different bypass conditions are used to illustrate the settling time characteristics of the amplifier. Note that although the output waveform looks acceptable at 1V/div, when amplified to 1mV/div the settling time to 2mV is 4.244 $\mu$ s for the 0.1 $\mu$ F bypass; the time drops to 163ns with multiple bypass capacitors.

Settling Time Poor Bypass

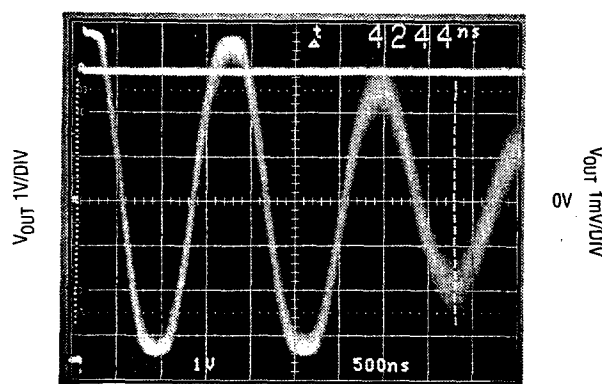

SETTLING TIME TO 2mV,  $A_V = -1$   
SUPPLY BYPASS CAPACITORS = 0.1 $\mu$ F

LT1190 - TA06

Settling Time Good Bypass

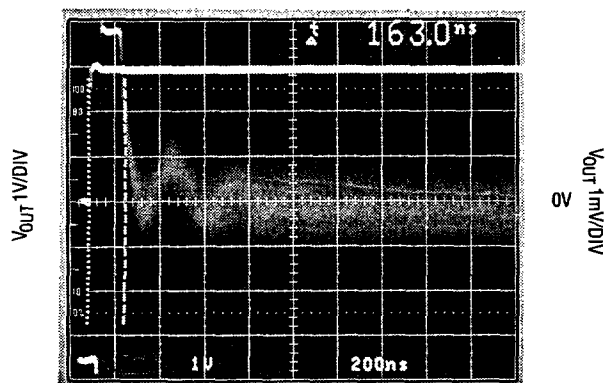

SETTLING TIME TO 2mV,  $A_V = -1$   
SUPPLY BYPASS CAPACITORS = 0.1 $\mu$ F + 4.7 $\mu$ F TANTALUM

LT1190 - TA07

2



# APPLICATIONS INFORMATION

## Cable Terminations

The LT1190 operational amplifier has been optimized as a low cost video cable driver. The  $\pm 50\text{mA}$  guaranteed output current enables the LT1190 to easily deliver  $7.5\text{Vp-p}$  into  $100\Omega$ , while operating on  $\pm 5\text{V}$  supplies, or  $2.6\text{Vp-p}$  on a single  $5\text{V}$  supply.

Double Terminated Cable Driver

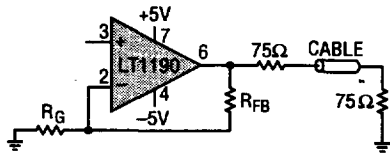

Cable Driver Voltage Gain vs Frequency

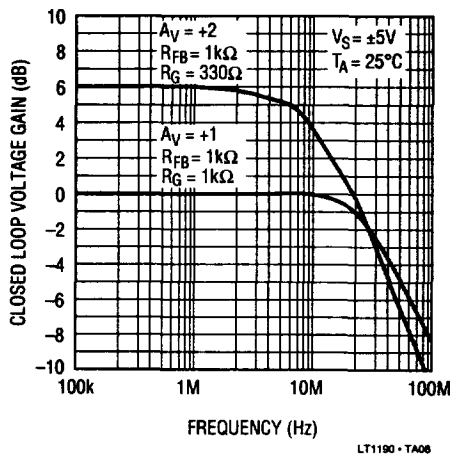

When driving a cable it is important to terminate the cable to avoid unwanted reflections. This can be done in one of two ways: single termination or double termination. With single termination, the cable must be terminated at the receiving end ( $75\Omega$  to ground) to absorb unwanted energy. The best performance can be obtained by double termination ( $75\Omega$  in series with the output of the amplifier, and  $75\Omega$  to ground at the other end of the cable). This termination is preferred because reflected energy is absorbed at each end of the cable. When using the double termination technique it is important to note that the signal is attenuated by a factor of 2, or  $6\text{dB}$ . This can be compensated for by taking a gain of 2, or  $6\text{dB}$  in the amplifier. The cable driver has a  $-3\text{dB}$  bandwidth in excess of  $30\text{MHz}$  while driving the  $150\Omega$  load.

## Using the Shutdown Feature

The LT1190 has a unique feature that allows the amplifier to be shutdown for conserving power, or for multiplexing several amplifiers onto a common cable. The amplifier will shutdown by taking pin 5 to  $V^-$ . In shutdown, the amplifier dissipates  $15\text{mW}$  while maintaining a true high impedance output state of  $15\text{k}\Omega$  in parallel with the feedback resistors. The amplifiers must be used in a non-inverting configuration for MUX applications. In inverting configurations the input signal is fed to the output through the feedback components. The following scope photos show that with very high  $R_L$ , the output is truly high impedance; the output slowly decays toward ground. Additionally, when the output is loaded with as little as  $1\text{k}\Omega$  the amplifier shuts off in  $400\text{ns}$ . This shutoff can be under the control of HC CMOS operating between  $0\text{V}$  and  $-5\text{V}$ .

Output Shutdown

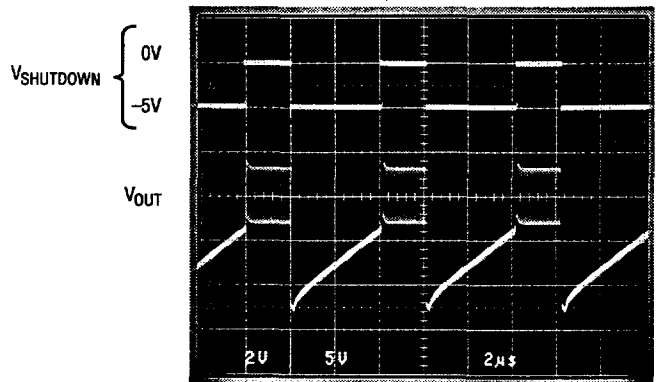

1MHz SINE WAVE GATED OFF WITH SHUTDOWN PIN,  $A_V = +1$ ,  $R_L = \text{SCOPE PROBE}$

LT1190 - TA09

Output Shutdown

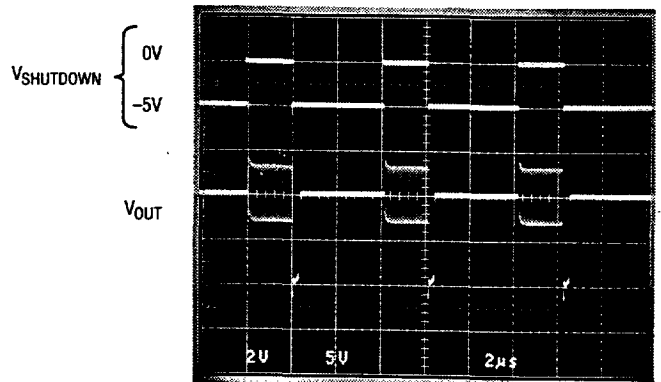

1MHz SINE WAVE GATED OFF WITH SHUTDOWN PIN,  $A_V = +1$ ,  $R_L = 1\text{k}\Omega$

LT1190 - TA10

## APPLICATIONS INFORMATION

The ability to maintain shutoff is shown on the curve Shutdown Supply Current vs Temperature in the Typical Performance Characteristics section. At very high elevated temperatures it is important to hold the shutdown pin close to the negative supply to keep the supply current from increasing.

### Murphy Circuits

There are several precautions the user should take when using the LT1190 in order to realize its full capability. Although the LT1190 can drive a 50pF load, isolating the capacitance with 10Ω can be helpful. Precautions primarily have to do with driving large capacitive loads.

Other precautions include:

1. Use a ground plane (see Design Note 50, High Frequency Amplifier Evaluation Board).
2. Do not use high source impedances. The input capacitance of 2pF, and  $R_S = 10k\Omega$  for instance, will give an 8MHz – 3dB bandwidth.
3. PC board socket may reduce stability.
4. A feedback resistor of 1kΩ or lower reduces the effects of stray capacitance at the inverting input. (For instance, closed loop gain of +2 can use  $R_{FB} = 300\Omega$  and  $R_G = 300\Omega$ .)

2

Driving Capacitive Load

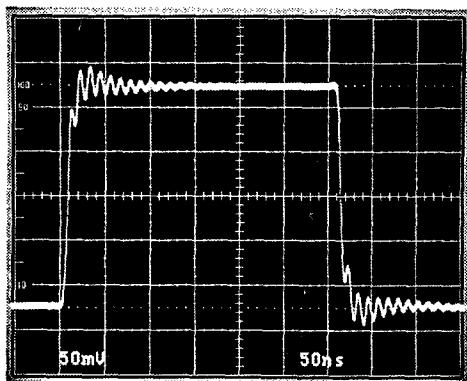

$A_V = -1$ , IN DEMO BOARD,  $C_L = 50pF$

LT1190 - TA11

Driving Capacitive Load

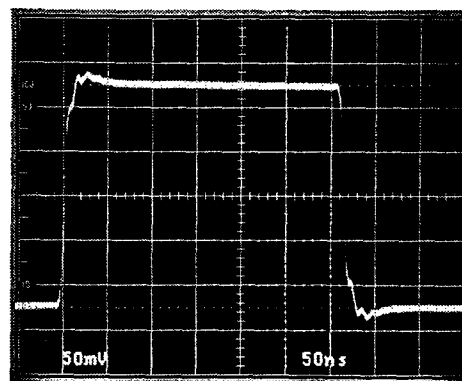

$A_V = -1$ , IN DEMO BOARD,  $C_L = 50pF$  WITH  
10Ω ISOLATING RESISTOR

LT1190 - TA12

### Murphy Circuits

**SIMPLIFIED SCHEMATIC**

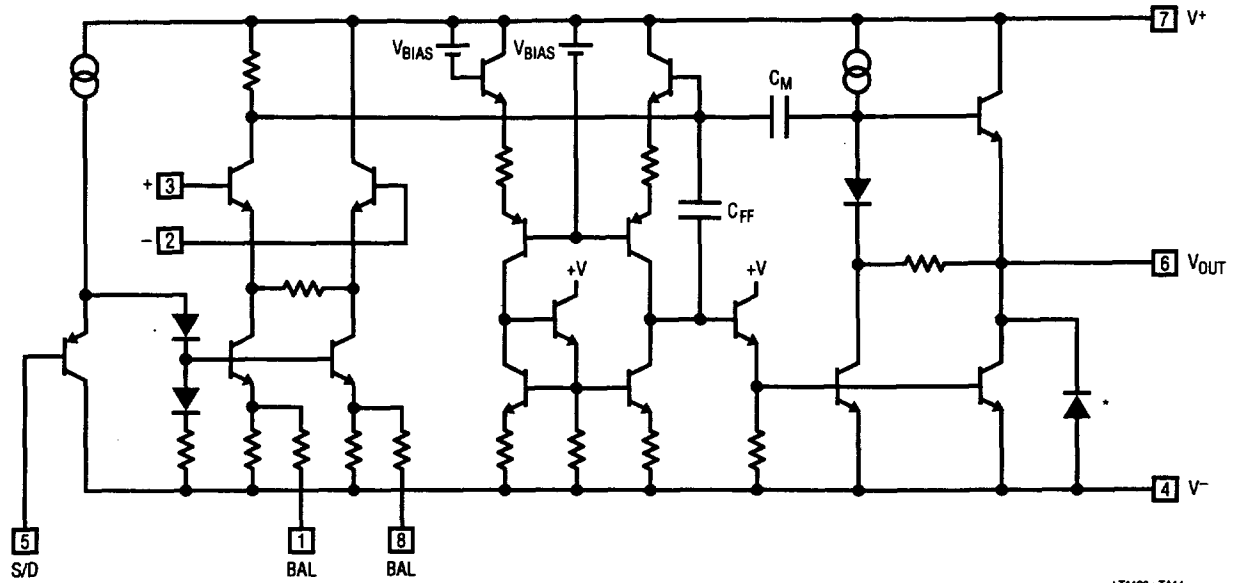

\* SUBSTRATE DIODE, DO NOT FORWARD BIAS

LT1190-TA14