

# Low Noise, 8th Order, Clock Sweepable Elliptic Lowpass Filter

## FEATURES

- 8th Order Filter in a 14-Pin Package
- No External Components
- 100:1 Clock to Center Ratio
- $150\mu\text{V}_{\text{RMS}}$  Total Wideband Noise
- 0.03% THD or Better
- 50kHz Maximum Corner Frequency
- Operates from  $\pm 2.37\text{V}$  to  $\pm 8\text{V}$  Power Supplies
- Passband Ripple Guaranteed Over Full Military Temperature Range

## APPLICATIONS

- Antialiasing Filters
- Telecom PCM Filters

## DESCRIPTION

The LTC1064-1 is an 8th order, clock sweepable elliptic (Cauer) lowpass switched capacitor filter. The passband ripple is typically  $\pm 0.15\text{dB}$ , and the stopband attenuation at 1.5 times the cutoff frequency is 68dB or more.

An external TTL or CMOS clock programs the value of the filter's cutoff frequency. The clock to cutoff frequency ratio is 100:1.

No external components are needed for cutoff frequencies up to 20kHz. For cutoff frequencies over 20kHz two low value capacitors are required to maintain passband flatness. The LTC1064-1 features low wideband noise and low harmonic distortion even for input voltages up to  $3\text{V}_{\text{RMS}}$ . In fact the LTC1064-1 overall performance competes with equivalent multi op amp RC active realizations.

The LTC1064-1 is available in a 14-pin DIP or 16-pin surface mounted SOL package.

The LTC1064-1 is pin compatible with the LTC1064-2.

## TYPICAL APPLICATION

### 8th Order Clock Sweepable Lowpass Elliptic Antialiasing Filter

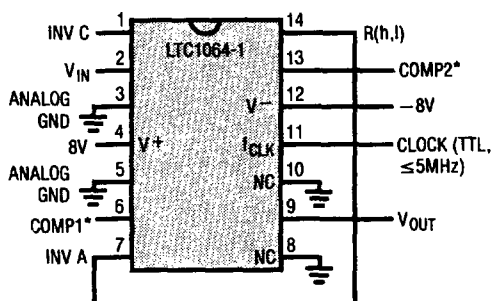

NOTE: THE POWER SUPPLIES SHOULD BE BYPASSED BY A  $0.1\mu\text{F}$  CAPACITOR CLOSE TO THE PACKAGE.

FOR SERVO OFFSET NULLING APPLICATIONS, PIN 1 IS THE 2ND STAGE SUMMING JUNCTION.

\*FOR CUTOFF FREQUENCY ABOVE 20kHz, USE COMPENSATION CAPACITORS ( $5\text{pF}$ – $56\text{pF}$ ) BETWEEN PINS 13 AND 1 AND 6 AND 7.

### Frequency Response

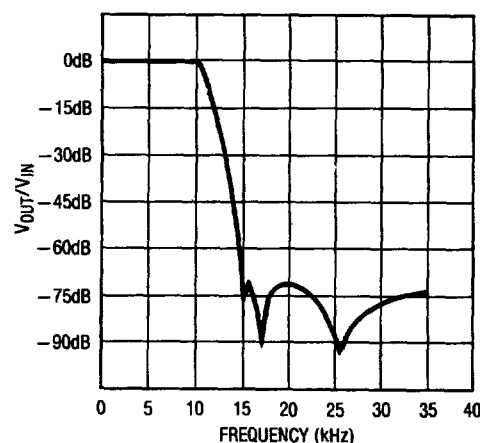

8TH ORDER CLOCK SWEEPABLE LOWPASS ELLIPTIC ANTIALIASING FILTER MAINTAINS, FOR  $0.1\text{Hz} \leq f_{\text{CUTOFF}} \leq 10\text{kHz}$ , a  $\pm 0.15\text{dB}$  PASSBAND RIPPLE AND 72dB STOPBAND ATTENUATION AT  $1.50 \times f_{\text{CUTOFF}}$ .  
 TOTAL WIDEBAND NOISE =  $150\mu\text{V}_{\text{RMS}}$ . THD = 0.03% FOR  $V_{\text{IN}} = 1\text{V}_{\text{RMS}}$ .

## ABSOLUTE MAXIMUM RATINGS

Total Supply Voltage ( $V^+$ to $V^-$ )	16.5V
Power Dissipation	400mW
Storage Temperature Range	-65°C to 150°C
Lead Temperature (Soldering, 10 sec.)	300°C
Operating Temperature Range	
LTC1064-1M	-55°C to 125°C
LTC1064-1C	-40°C to 85°C

## PACKAGE/ORDER INFORMATION

TOP VIEW		ORDER PART NUMBER
<p>J PACKAGE 14-LEAD CERAMIC DIP</p> <p>N PACKAGE 14-LEAD PLASTIC DIP</p>	<p>INVC 1, VIN 2, AGND 3, V+ 4, AGND 5, COMP1 6, INVA 7, R(h,l) 14, COMP2 13, V- 12, fCLK 11, NC 10, VOUT 9, NC 8</p>	<p>LTC1064-1MJ LTC1064-1CJ LTC1064-1CN</p>
<p>S PACKAGE 16-LEAD PLASTIC SOL</p>	<p>INVC 1, VIN 2, AGND 3, V+ 4, AGND 5, NC 6, COMP1 7, INVA 8, R(h,l) 16, COMP2 15, V- 14, NC 13, fCLK 12, NC 11, NC 10, VOUT 9</p>	<p>LTC1064-1CS</p>

## ELECTRICAL CHARACTERISTICS

$V_S = \pm 7.5V$ ,  $f_{CLK} = 1MHz$ ,  $R_I = 10k\Omega$ ,  $C_I = 10pF$ ,  $T_A = 25^\circ$ , TTL or CMOS clock input level unless otherwise specified.

PARAMETER	CONDITIONS	MIN	TYP	MAX	UNITS
Passband Gain, LTC1064-1, 1A	Referenced to 0dB, 1Hz to $0.1f_C$		$\pm 0.1$	$\pm 0.35$	dB
Gain TempCo			0.0002		dB/°C
Passband Edge Frequency, $f_C$			$10 \pm 1\%$		kHz
Gain at $f_C$	Referenced to Passband Gain				
LTC1064-1		-1.25		0.85	dB
LTC1064-1A		-0.75		0.65	dB
-3dB Frequency			10.7		kHz
Passband Ripple (Note 1)	$0.1f_C$ to $0.85f_C$ Referenced to Passband Gain, Measured at 6.25kHz and 8.5kHz		$\pm 0.15$	$\pm 0.32$	dB
LTC1064-1			$\pm 0.1$	$\pm 0.19$	dB
LTC1064-1A			0.0004		dB/°C
Ripple TempCo					dB/°C
Stopband Attenuation	At $1.5f_C$ , Referenced to 0dB				
LTC1064-1		66	72		dB
LTC1064-1A		68	72		dB
Stopband Attenuation	At $2f_C$ , Referenced to 0dB				
LTC1064-1		67	72		dB
LTC1064-1A		68	72		dB
Input Frequency Range		0		$f_{CLK}/2$	kHz
Output Voltage Swing and Operating Input Voltage Range	$V_S = \pm 2.37V$	-1.0		1	V
	$V_S = \pm 5V$	-3.2		3.2	V
	$V_S = \pm 7.5V$	-5.0		5.2	V

## ELECTRICAL CHARACTERISTICS

$V_S = \pm 7.5V$ ,  $f_{CLK} = 1MHz$ ,  $R_I = 10k\Omega$ ,  $C_I = 10pF$ ,  $T_A = 25^\circ$ , TTL or CMOS clock input level unless otherwise specified.

PARAMETER	CONDITIONS	MIN	TYP	MAX	UNITS
Total Harmonic Distortion	$V_S = \pm 5V$ , Input = $1V_{RMS}$ at 1kHz		0.015		%
	$V_S = \pm 7.5V$ , Input = $3V_{RMS}$ at 1kHz		0.03		%
Wideband Noise	$V_S = \pm 5V$ , Input = GND 1Hz-999kHz		150		$\mu V_{RMS}$
	$V_S = \pm 7.5V$ , Input = GND 1Hz-999kHz		165		$\mu V_{RMS}$
Output DC Offset LTC1064-1 LTC1064-1A	$V_S = \pm 7.5V$ , Pin 2 Grounded		50	175	mV
			50	125	mV
Output DC Offset TempCo	$V_S = \pm 5V$		-100		$\mu V/^\circ C$
Input Impedance		10	20		k $\Omega$
Output Impedance	$f_{OUT} = 10kHz$		2		$\Omega$
Output Short Circuit Current	Source/Sink		3/1		mA
Clock Feedthrough			200		$\mu V_{RMS}$
Maximum Clock Frequency	50% Duty Cycle, $V_S = \pm 7.5V$			5	MHz
Power Supply Current	$V_S = \pm 2.37V$	●	10	16	mA
	$V_S = \pm 5V$	●	12	18	mA
		●		22	mA
	$V_S = \pm 8V$	●	16	22	mA
				28	mA
Power Supply Voltage Range		●	$\pm 2.37$	$\pm 8$	V

The ● denotes the specifications which apply over the full operating temperature range.

Note 1: For tighter specifications please contact LTC Marketing.

## TYPICAL APPLICATIONS

7

Graph 1. Gain vs Frequency

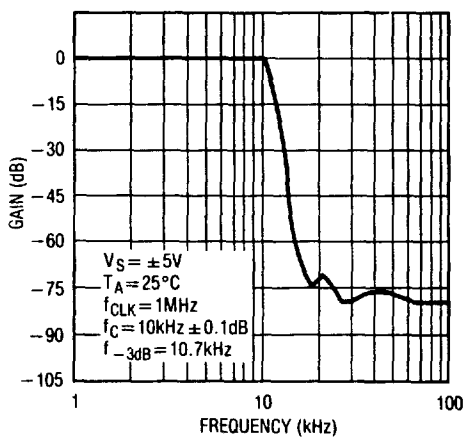

Graph 2. Phase vs Frequency

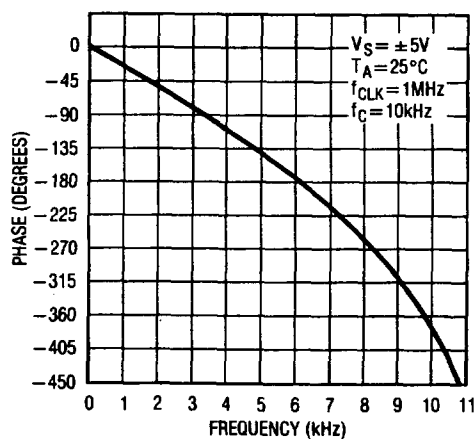

Graph 3. Group Delay

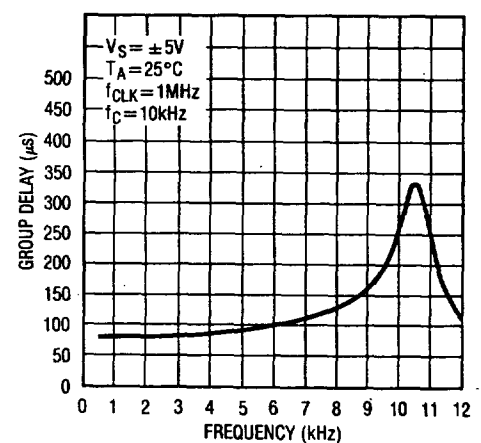

# TYPICAL APPLICATIONS

**Graph 4. Gain vs Frequency**

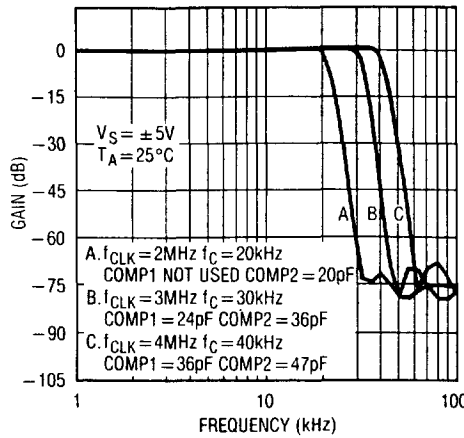

**Graph 5. Gain vs Frequency**

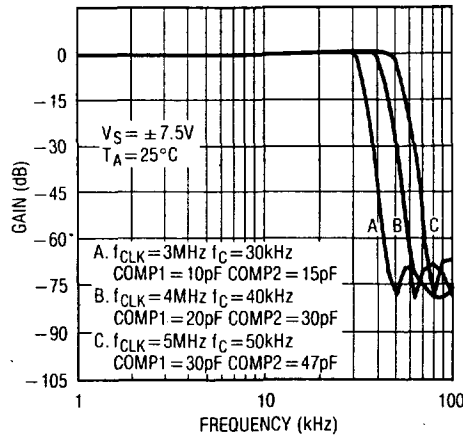

**Graph 6. Gain vs Frequency**

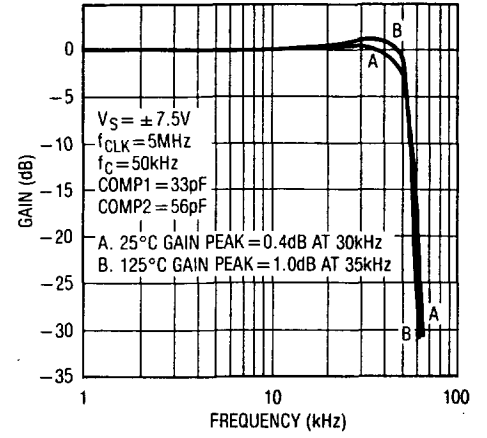

**Graph 7. Typical Wideband Noise (151µVRMS) VS = ±5V TA = 25°C fCLK = 1MHz fC = 10kHz Input Grounded**

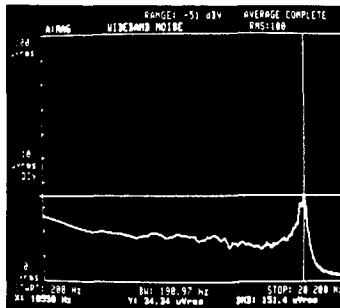

**Graph 8. Total Harmonic Distortion (0.025%) VS = ±7.5V TA = 25°C fCLK = 1MHz fC = 10kHz Input = 1kHz at 3V RMS**

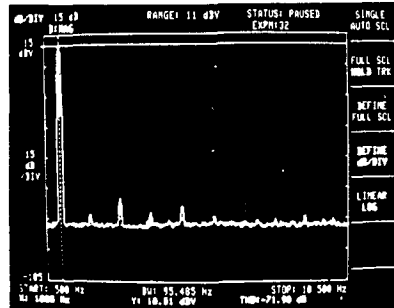

**Graph 9. Power Supply Current vs Power Supply Voltage**

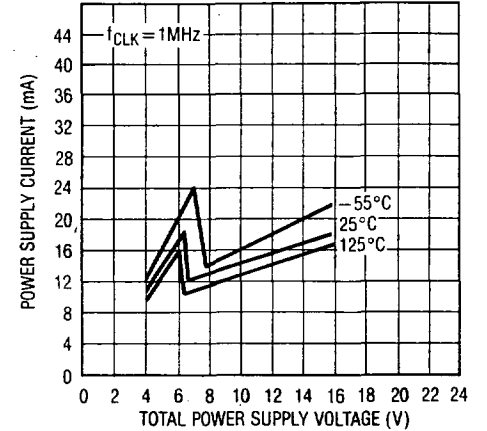

## PIN DESCRIPTION

### Power Supply Pins (4, 12)

The  $V^+$  (pin 4) and  $V^-$  (pin 12) should be bypassed with a 0.1µF capacitor to an adequate analog ground. Low noise, non-switching power supplies are recommended. To avoid latch up when the power supplies exhibit high turn-on transients, a 1N5817 schottky diode should be added from the  $V^+$  and  $V^-$  pins to ground, Figure 1.

### Clock Pin (11)

For ±5V supplies the logic threshold level is 1.4V. For ±8V and 0V to 5V supplies the logic threshold levels are

2.2V and 3V respectively. The logic threshold levels vary ±100mV over the full military temperature range. The recommended duty cycle of the input clock is 50% although for clock frequencies below 500kHz the clock “on” time can be as low as 200ns. The maximum clock frequency for ±5V supplies is 4MHz. For ±7V supplies and above, the maximum clock frequency is 5MHz. Do not allow the clock levels to exceed the power supplies. For clock level shifting, see Figure 3.

### Analog Ground Pins (3, 5)

For dual supply operation these pins should be connected to a ground plane. For single supply operation both pins

## PIN DESCRIPTION

should be tied to one half supply, Figure 2. Also pins 8 and 10, although they are not internally connected should be tied to analog ground or system ground. This improves the clock feedthrough performance.

### Connection Pins (7, 14)

A very short connection between pins 14 and 7 is recommended. This connection should be preferably done under the IC package. In a breadboard, use a one inch, or less, shielded coaxial cable; the shield should be grounded. In a PC board, use a one inch trace or less; surround the trace by a ground plane.

### Compensation Pins (13 and 1, 6 and 7)

For filter cutoff frequencies higher than 20kHz, in order to minimize the passband ripple, compensation capacitors should be added between pins 6 and 7 (comp1) and pins 1 and 13 (comp2). For comp1 (comp2), add 1pF (1.5pF) mica

capacitor for each kHz increase in cutoff frequency above 20kHz. For more details refer to graphs 4, 5, and 6.

### Input, Output Pins (2, 9)

The input pin 2 is connected to an 18k $\Omega$  resistor tied to the inverting input of an op amp. Pin 2 is protected against static discharge. The device's output, pin 9, is the output of an op amp which can typically source/sink 3/1mA. Although the internal op amps are unity gain stable, driving long coax cables is not recommended.

When testing the device for noise and distortion, the output, pin 9, should be buffered, Figure 4. **The op amp power supply wire (or trace) should be connected directly to the power source.**

### NC Pins (8, 9)

The "no connection" pins preferably should be grounded.

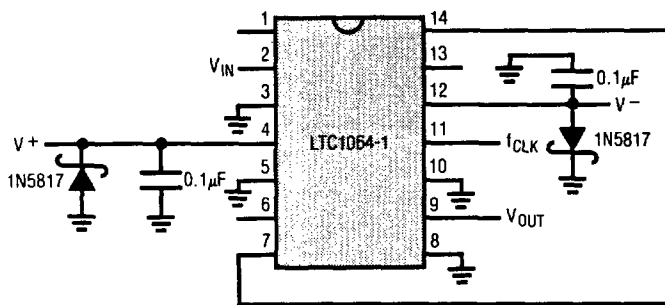

Figure 1. Using Schottky Diodes to Protect the IC from Power Supply Spikes.

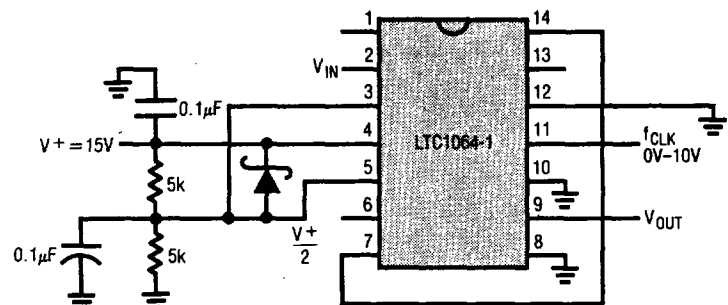

Figure 2. Single Supply Operation. If Fast Power Up or Down Transients are Expected, Use a 1N5817 Schottky Diode Between Pins 4 and 5.

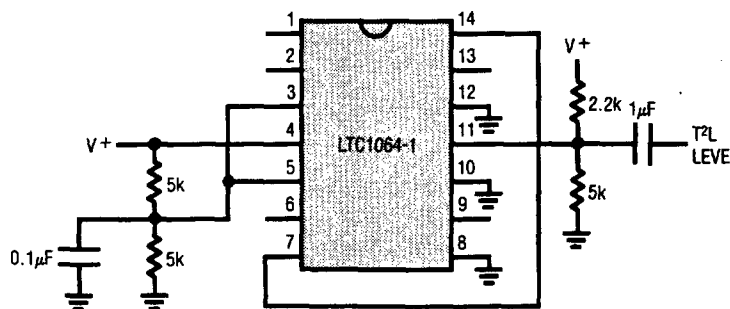
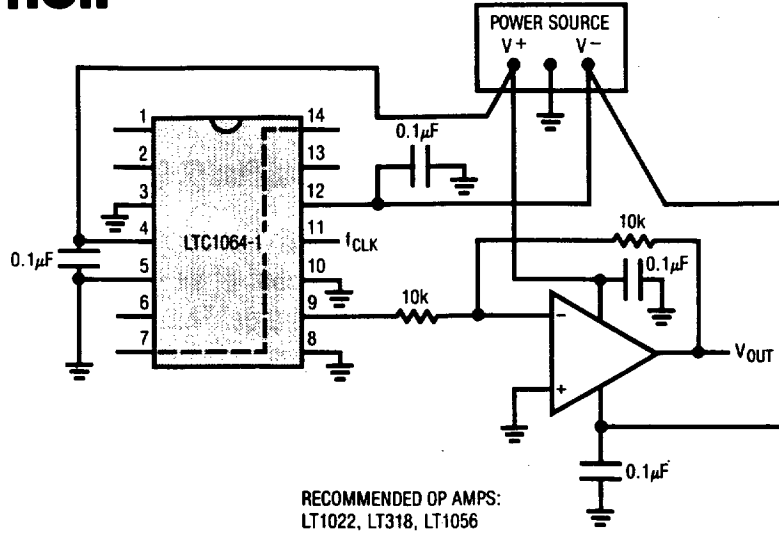

Figure 3. Level Shifting the Input T<sup>2</sup>L Clock for Single Supply Operation, V<sup>+</sup> > 6V

**PIN DESCRIPTION**



**Figure 4. Buffering the Filter Output. The Buffer Op Amp Should Not Share the LTC1064-1 Power Lines.**

**TYPICAL APPLICATIONS**

**Transitional Elliptic-Bessel 10th Order Lowpass Filter**

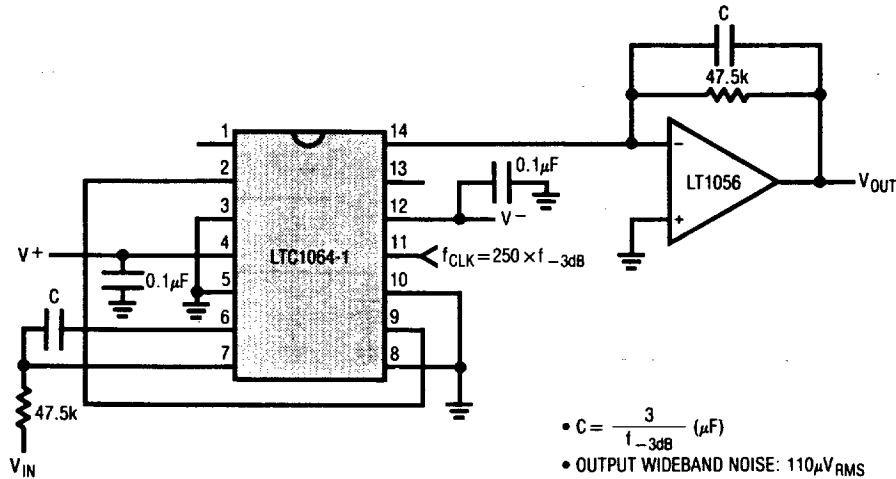

**Transient Response to a 2V Step Input**  
Horizontal: 0.1ms/Div  
Vertical: 1V/Div

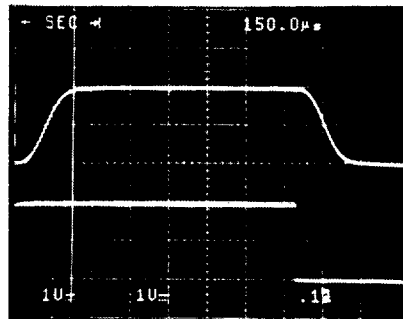

**Amplitude Response**

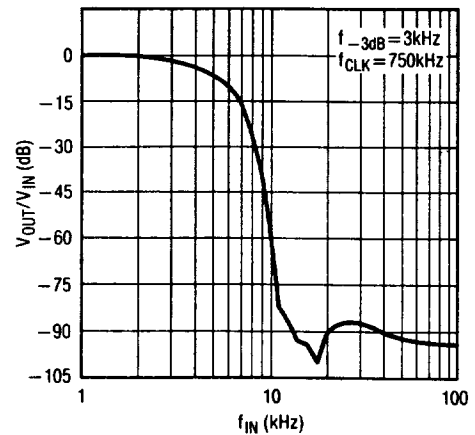

# TYPICAL APPLICATIONS

## Transitional Elliptic-Bessel Dual 5th Order Lowpass Filter

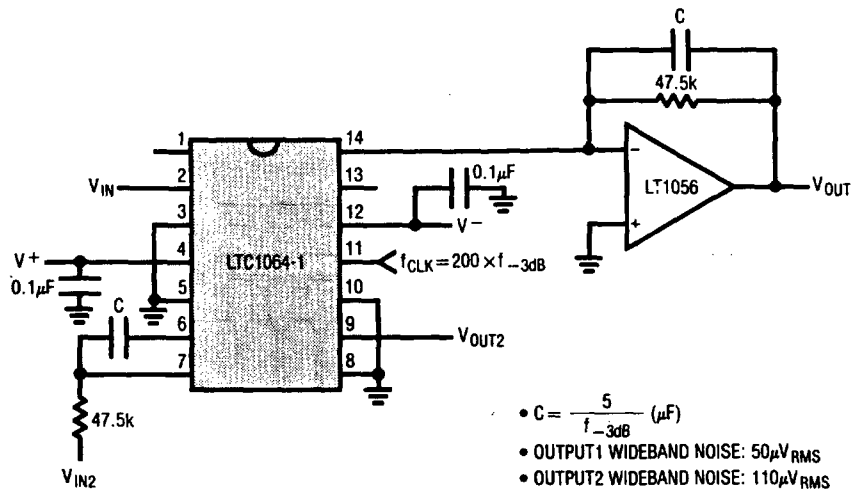

Transient Response to a 2V Step Input  
Horizontal: 0.1ms/Div  
Vertical: 1V/Div

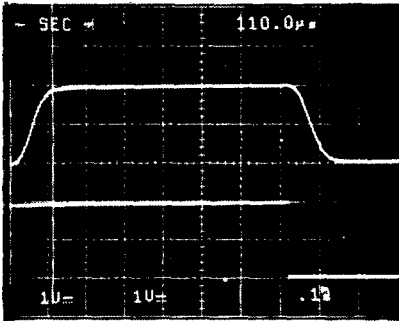

V<sub>OUT2</sub>

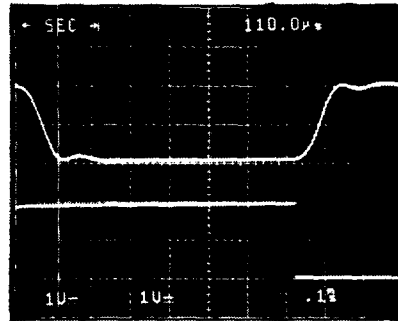

V<sub>OUT1</sub>

Amplitude Response

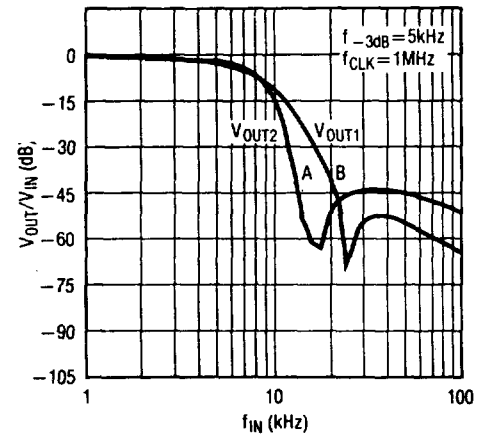

7

Adding an Output Buffer-Filter to Eliminate Any Clock Feedthrough  
Over a 10:1 Clock Range, for  $f_C = 2kHz$  to  $20kHz$

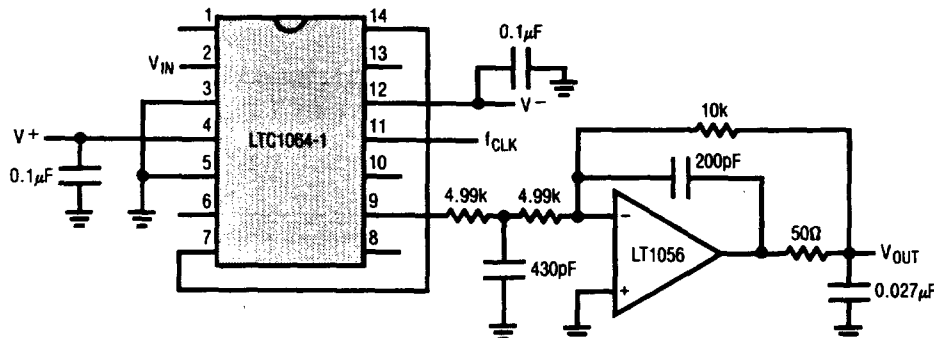

**PACKAGE DESCRIPTION** Dimensions in inches (millimeters) unless otherwise noted.

**J Package**  
14-Lead Ceramic DIP

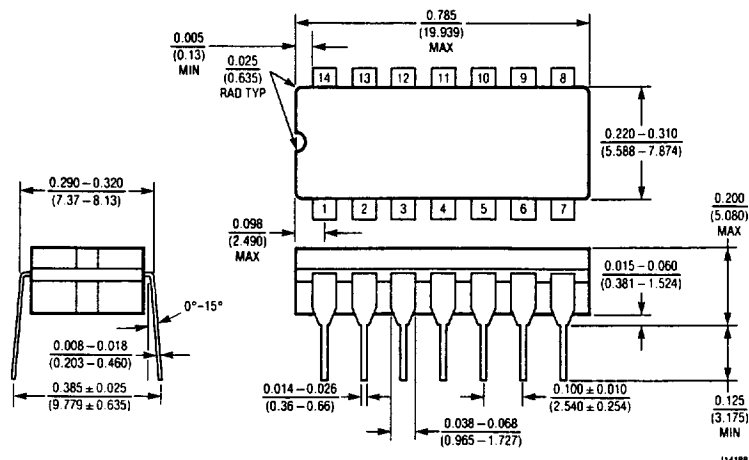

**N Package**  
14-Lead Plastic DIP

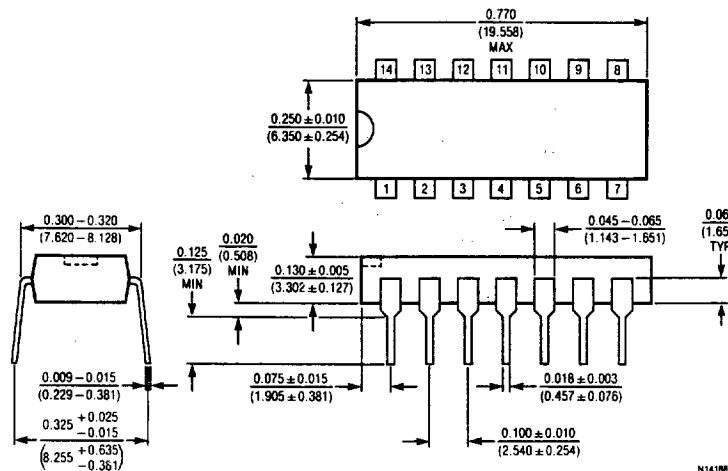

**S Package**  
16-Lead Plastic SOL

