

General Purpose Transistor

PNP Silicon

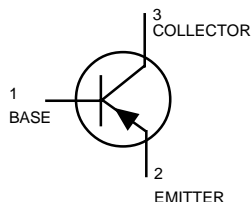

MMBT2907LT1
MMBT2907ALT1

MAXIMUM RATINGS

Rating	Symbol	Value		Unit
		2907	2907A	
Collector–Emitter Voltage	V_{CEO}	-40	-60	Vdc
Collector–Base Voltage	V_{CBO}		-60	Vdc
Emitter–Base Voltage	V_{EBO}		-5.0	Vdc
Collector Current — Continuous	I_C		-600	mAdc

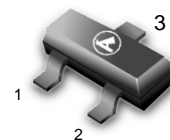

CASE 318-08, STYLE 6
SOT-23 (TO-236AB)

THERMAL CHARACTERISTICS

Characteristic	Symbol	Max	Unit
Total Device Dissipation FR-5 Board, (1) $T_A = 25^\circ\text{C}$	P_D	225	mW
Derate above 25°C		1.8	mW/ $^\circ\text{C}$
Thermal Resistance, Junction to Ambient	$R_{\theta JA}$	556	$^\circ\text{C}/\text{W}$
Total Device Dissipation Alumina Substrate, (2) $T_A = 25^\circ\text{C}$	P_D	300	mW
Derate above 25°C		2.4	mW/ $^\circ\text{C}$
Thermal Resistance, Junction to Ambient	$R_{\theta JA}$	417	$^\circ\text{C}/\text{W}$
Junction and Storage Temperature	T_J, T_{stg}	-55 to +150	$^\circ\text{C}$

DEVICE MARKING

MMBT2907LT1 = M2B, MMBT2907ALT1 = 2F

ELECTRICAL CHARACTERISTICS ($T_A = 25^\circ\text{C}$ unless otherwise noted.)

Characteristic	Symbol	Min	Max	Unit
----------------	--------	-----	-----	------

OFF CHARACTERISTICS

Collector–Emitter Breakdown Voltage(3) ($I_C = -10 \text{ mAdc}, I_E = 0$)	$V_{(BR)CEO}$			Vdc
	MMBT2907	-40	—	
	MMBT2907A	-60	—	
Collector–Emitter Breakdown Voltage($I_C = -10 \mu\text{Adc}, I_E = 0$)	$V_{(BR)CBO}$	-60	—	Vdc
Emitter–Base Breakdown Voltage($I_E = -10 \mu\text{Adc}, I_C = 0$)	$V_{(BR)EBO}$	-5.0	—	Vdc
Collector Cutoff Current($V_{CB} = -30\text{Vdc}, I_{BE(off)} = -0.5\text{Vdc}$)	I_{CEX}	—	-50	nAdc
Collector Cutoff Current ($V_{CB} = -50\text{Vdc}, I_E = 0$)	I_{CBO}			μAdc
	MMBT2907	—	-0.020	
	MMBT2907A	—	-0.010	
($V_{CB} = -50\text{Vdc}, I_E = 0, T_A = 125^\circ\text{C}$)	MMBT2907	—	-20	
	MMBT2907A	—	-10	
Base Current($V_{CE} = -30\text{Vdc}, V_{EB(off)} = -0.5\text{Vdc}$)	I_B	—	-50	nAdc

- FR-5 = $1.0 \times 0.75 \times 0.062$ in.
- Alumina = $0.4 \times 0.3 \times 0.024$ in. 99.5% alumina.
- Pulse Test: Pulse Width $\leq 300 \mu\text{s}$, Duty Cycle $\leq 2.0\%$.

MMBT2907LT1 MMBT2907ALT1

ELECTRICAL CHARACTERISTICS ($T_A = 25^\circ\text{C}$ unless otherwise noted) (Continued)

Characteristic	Symbol	Min	Max	Unit
ON CHARACTERISTICS				
DC Current Gain ($I_C = -0.1\text{mA}$, $V_{CE} = -10\text{Vdc}$)	h_{FE}	35	—	—
		MMBT2907	75	—
($I_C = -1.0\text{mA}$, $V_{CE} = -10\text{Vdc}$)		50	—	
		MMBT2907A	100	—
($I_C = -10\text{mA}$, $V_{CE} = -10\text{Vdc}$)		75	—	
		MMBT2907A	100	—
($I_C = -150\text{mA}$, $V_{CE} = -10\text{Vdc}$)(3)		—	—	
		MMBT2907A	100	300
($I_C = -500\text{mA}$, $V_{CE} = -10\text{Vdc}$)(3)		30	—	
		MMBT2907A	50	—
Collector–Emitter Saturation Voltage(3) ($I_C = -150\text{mA}$, $I_B = -15\text{mA}$) ($I_C = -500\text{mA}$, $I_B = -50\text{mA}$)	$V_{CE(sat)}$	—	-0.4	Vdc
		—	-1.6	
Base–Emitter Saturation Voltage(3) ($I_C = -150\text{mA}$, $I_B = -15\text{mA}$) ($I_C = -500\text{mA}$, $I_B = -50\text{mA}$)	$V_{BE(sat)}$	—	-1.3	Vdc
		—	-2.6	

SMALL-SIGNAL CHARACTERISTICS

Current–Gain — Bandwidth Product(3),(4) ($I_C = -50\text{mA}$, $V_{CE} = -20\text{Vdc}$, $f = 100\text{MHz}$)	f_T	200	—	MHz
Output Capacitance ($V_{CB} = -10\text{Vdc}$, $I_E = 0$, $f = 1.0\text{MHz}$)	C_{obo}	—	8.0	pF
Input Capacitance ($V_{EB} = -2.0\text{Vdc}$, $I_C = 0$, $f = 1.0\text{MHz}$)	C_{ibo}	—	30	pF

SWITCHING CHARACTERISTICS

Turn–On Time Delay Time Rise Time	($V_{CC} = -30\text{Vdc}$, $I_C = -150\text{mA}$, $I_{B1} = -15\text{mA}$)	t_{on} t^d t_r	— — —	45 10 40	ns
Fall Time Storage Time Turn–Off Time	($V_{CC} = -6.0\text{Vdc}$, $I_C = -150\text{mA}$, $I_{B1} = I_{B2} = 15\text{mA}$)	t_f t_s t_{off}	— — —	30 80 100	ns

3. Pulse Test: Pulse Width $\leq 300\ \mu\text{s}$, Duty Cycle $\leq 2.0\%$.

4. f_T is defined as the frequency at which $|h_{fe}|$ extrapolates to unity.

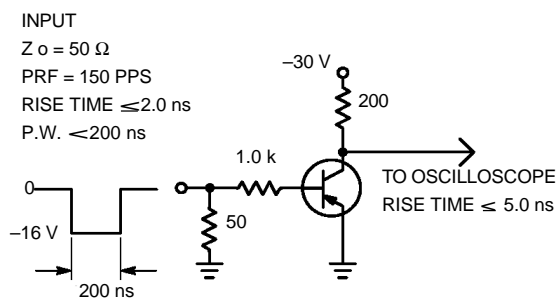

Figure 1. Delay and Rise Time Test Circuit

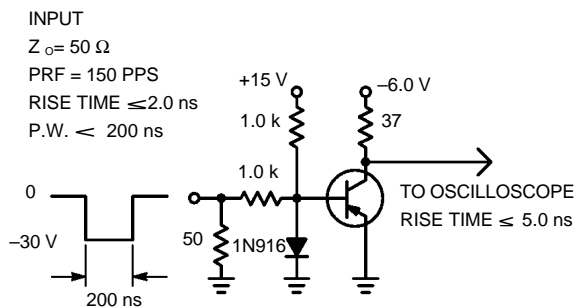

Figure 2. Storage and Fall Time Test Circuit

MMBT2907LT1 MMBT2907ALT1

TYPICAL CHARACTERISTICS

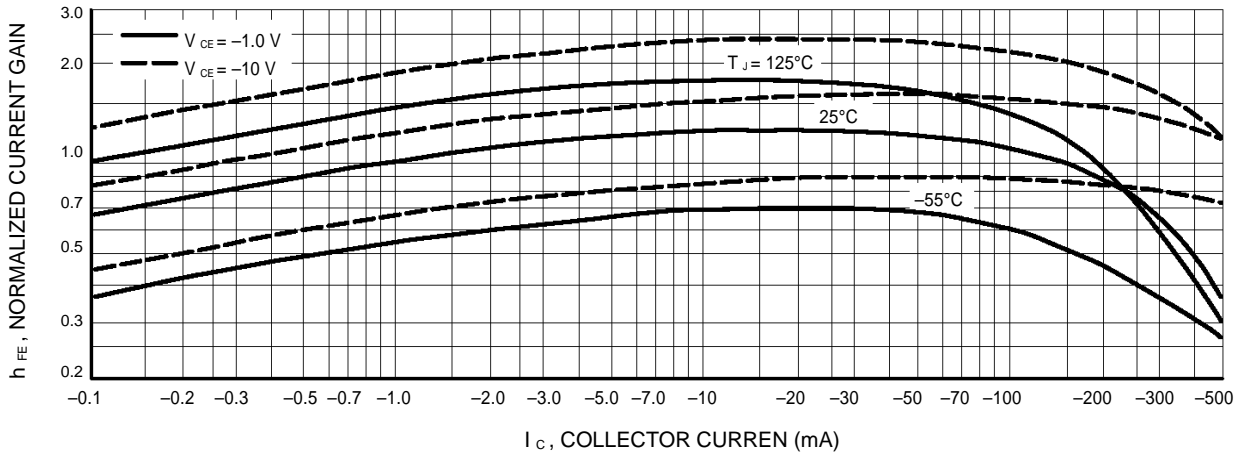

Figure 3. DC Current Gain

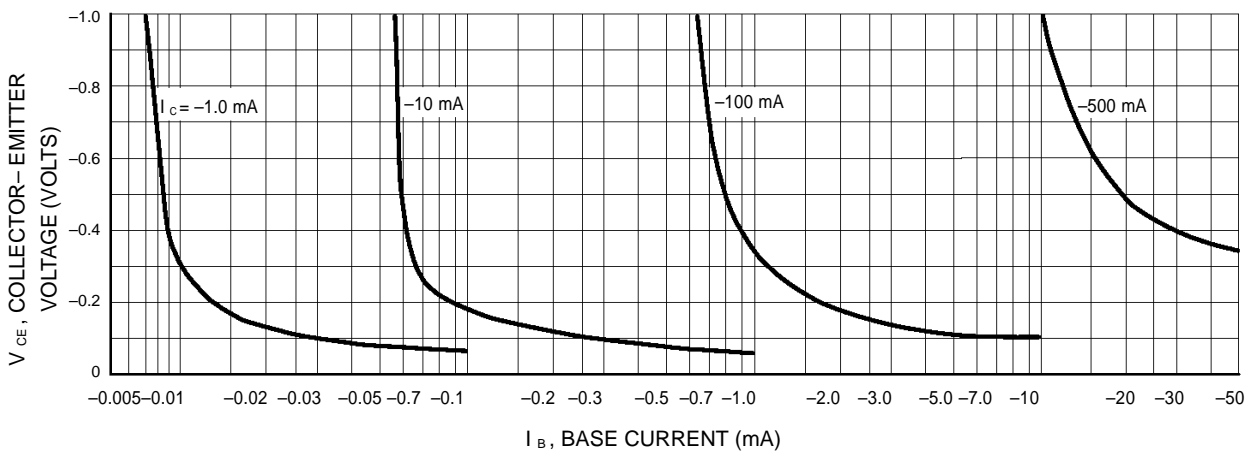

Figure 4. Collector Saturation Region

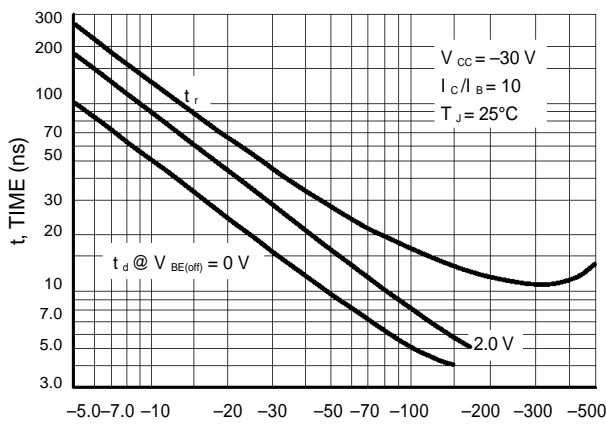

Figure 5. Turn-On Time

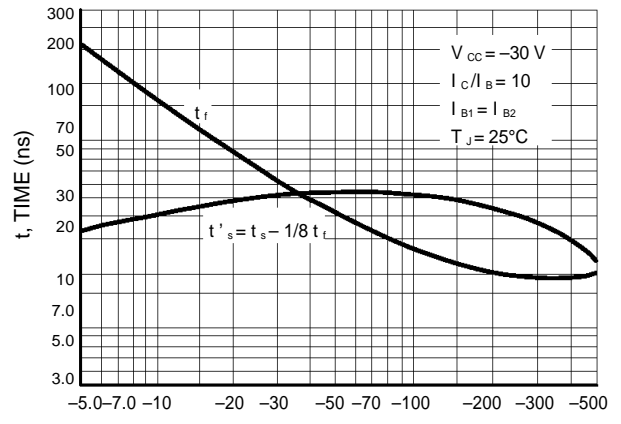

Figure 6. Turn-Off Time

MMBT2907LT1 MMBT2907ALT1

TYPICAL SMALL-SIGNAL CHARACTERISTICS

NOISE FIGURE

$V_{CE} = 10 \text{ Vdc}$, $T_A = 25^\circ\text{C}$

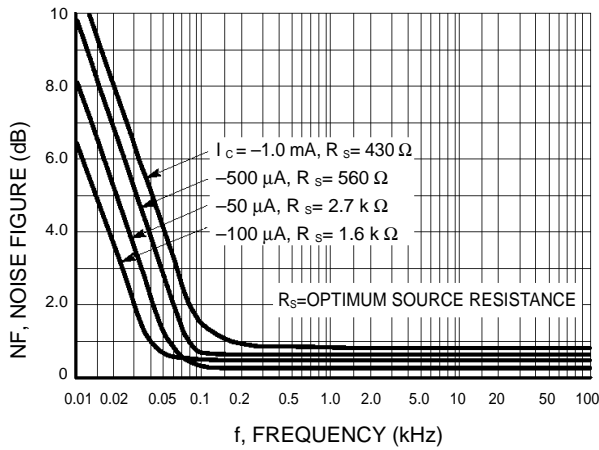

Figure 7. Frequency Effects

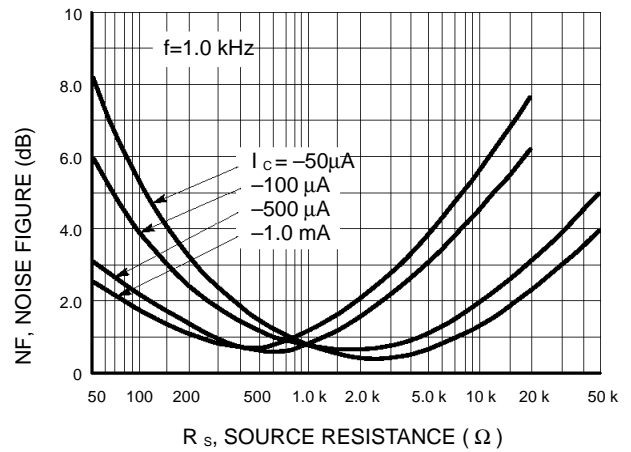

Figure 8. Source Resistance Effects

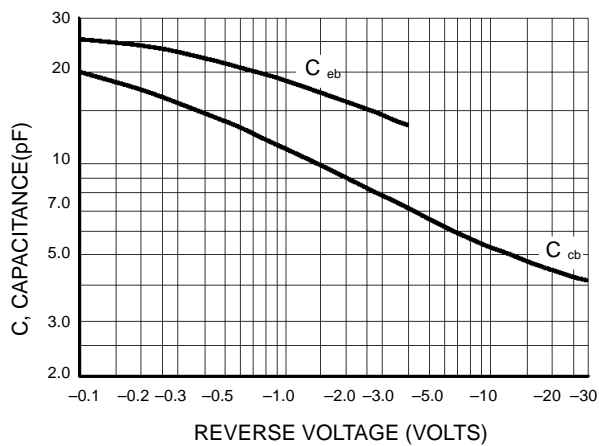

Figure 9. Capacitances

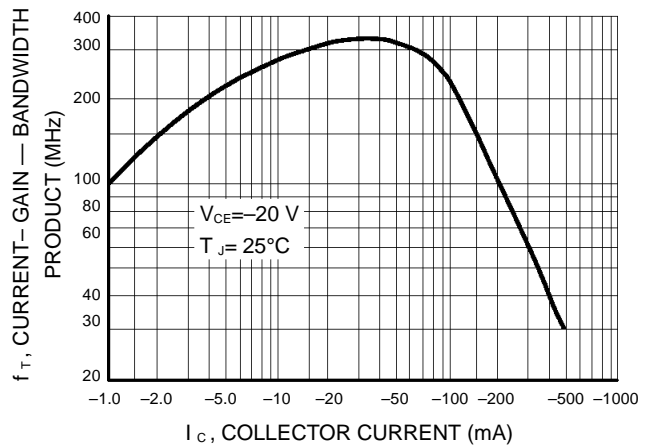

Figure 10. Current-Gain — Bandwidth Product

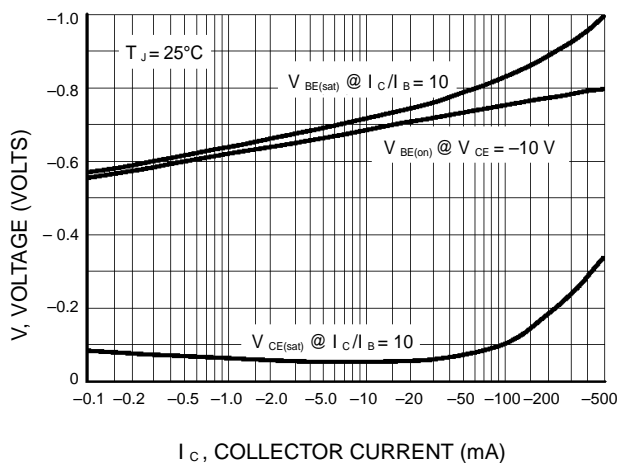

Figure 11. "On" Voltage

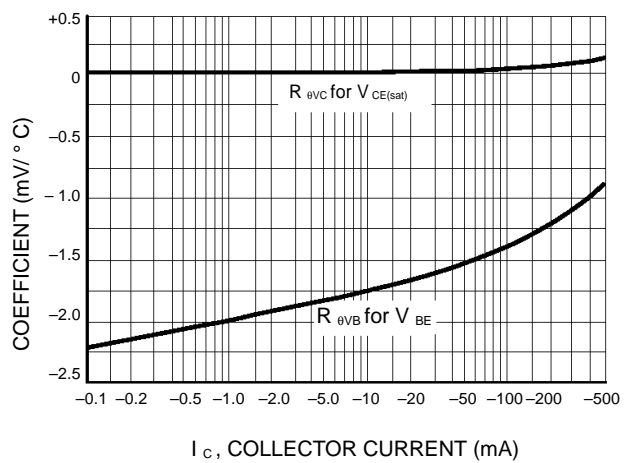

Figure 12. Temperature Coefficients